

SM500F

Field mountable paperless recorder



Measurement made easy

—
SM500F field
mountable
paperless recorder

For more information

Further publications for the ProductDescription are available for free download from:

www.abb.com/measurement

or by scanning this code:



Search for or click on

Data Sheet
SM500F field mountable process recorder

[DS/SM500F-EN](#)

Commissioning Instruction
SM500f Field mountable process recorder







[CI/SM500F-EN](#)

Electrical safety

This equipment complies with the requirements of CEI/IEC 61010-1:2001-2 'Safety Requirements for Electrical Equipment for Measurement, Control and Laboratory Use'. If the equipment is used in a manner NOT specified by the Company, the protection provided by the equipment may be impaired.

Symbols

One or more of the following symbols may appear on the equipment labelling:

	Warning – refer to the manual for instructions
	Caution – risk of electric shock
	Protective earth (ground) terminal
	Earth (ground) terminal
	Direct current supply only
	Alternating current supply
	Both direct and alternating current supply
	The equipment is protected through double insulation

Information in this manual is intended only to assist our customers in the efficient operation of our equipment. Use of this manual for any other purpose is specifically prohibited and its contents are not to be reproduced in full or part without prior approval of the Technical Publications Department.

Health and safety

To ensure that our products are safe and without risk to health, the following points must be noted:

- The relevant sections of these instructions must be read carefully before proceeding.
- Warning labels on containers and packages must be observed.
- Installation, operation, maintenance and servicing must only be carried out by suitably trained personnel and in accordance with the information given.
- Normal safety precautions must be taken to avoid the possibility of an accident occurring when operating in conditions of high pressure and/or temperature.
- Chemicals must be stored away from heat, protected from temperature extremes and powders kept dry. Normal safe handling procedures must be used.
- When disposing of chemicals ensure that no two chemicals are mixed.

Safety advice concerning the use of the equipment described in this manual or any relevant hazard data sheets (where applicable) may be obtained from the Company address on the back cover, together with servicing and spares information.

Contents

1	Introduction	5
1.1	Functional Overview	5
2	Installation	7
2.1	Siting	8
2.2	Mounting	10
2.2.1	Panel-Mounting	11
2.2.2	Wall-Mounting	12
2.2.3	Pipe-Mounting (Optional)	13
2.3	Electrical Connections	14
2.3.1	Cable Entries	15
2.3.2	Connections	17
2.4	Single Analog/Digital Inputs	18
2.4.1	Thermocouple	18
2.4.2	Resistance Thermometer (RTD)	18
2.5	Dual Analog/Digital Inputs	19
2.5.1	Thermocouple	19
2.6	Power Supply Connections	20
2.7	Transmitter Power Supply Module	21
2.8	Relays	21
2.9	Modbus/Digital Input	21
2.9.1	Host Computer Serial Communications	22
2.9.2	Two-wire Connection	22
2.9.3	Pull-up and Pull-down Resistors	23
2.9.4	Termination Resistor	23
2.9.5	Serial Connections	23
3	On-Line Help	24
4	Operation	25
4.1	Powering up the Recorder	25
4.2	Operator Keys and Door Features	25
4.3	Operator Display Overview	26
4.4	Chart Views	27
4.4.1	Electronic Signatures	37
4.5	Indicator View	38
4.6	Audit Log View	42
4.7	Alarm Event Log	43
4.8	Totalizer Log	45

5	Logging	47
5.1	Logging Access	47
5.1.1	Password Entry	49
5.2	Logging Menu	50
6	Archiving	52
6.1	Introduction	52
6.2	Sample Rates	53
6.3	Archive File Types	53
6.4	Text Format Archive Files	54
6.4.1	Text Format Channel Data Files	54
6.4.2	Text Format Filename Examples	56
6.4.3	Text Format Log files	56
6.4.4	Text Format Data File Examples	57
6.4.5	Text Format Data File Digital Signatures	58
6.4.6	Text Format Data Verification and Integrity	58
6.5	Binary Format Archive Files	59
6.5.1	Binary Format Archive Filenames	59
6.5.2	Binary Format Channel Data Files	59
6.5.3	Binary Format Log files	60
6.5.4	Binary Format Data File Examples	61
6.5.5	Binary Format Data Verification and Integrity	62
6.6	Archiving Online/Offline	63
6.7	Backing-up Archived Data	64
6.8	Archive Wrap	64

7	Configuration	65
7.1	Introduction	65
7.2	Configuration Level Security	65
7.3	Configuration Level Access	66
7.4	Overview of Configuration	69
7.5	Making Changes to Parameters	70
7.6	Common Configuration	74
7.6.1	Setup	74
7.6.2	Screen	75
7.6.3	Time	76
7.6.4	Security	78
7.6.5	Users	80
7.6.6	Operator Messages	83
7.7	Process Group Configuration	84
7.7.1	Setting the Recording Parameters	84
7.7.2	Configuring the Chart View	87
7.7.3	Configuring the Indicator View	89
7.7.4	Archiving	90
7.7.5	Batch Recording	92
7.8	Channel Configuration	93
7.8.1	Recording Channel Setup	93
7.8.2	Analog Input Configuration	96
7.8.3	Digital Input Configuration	99
7.8.4	Alarm Configuration	100
7.8.5	Totalizer Configuration	107
7.8.6	F0 (Sterilization Optimization) Configuration	112
7.9	Functions	115
7.9.1	Custom Linearizers	115
7.9.2	Real-time Alarms	116
7.10	I/O Module Configuration	117
7.10.1	Analog Inputs	117
7.10.2	Relay Modules	119
7.10.3	Ethernet Module	120
7.10.4	E-Mail	122
7.10.5	RS485 (Modbus™) Communications	124
7.11	Modbus TCP	125
7.11.1	Client Authorization	126
7.11.2	Comms Analog Input	127
7.11.3	Comms Digital Input	129
7.12	Logic Editor	130
7.13	Math Equations	131
7.13.1	Using the Math Block Editor (Math Pad)	131
7.13.2	Math Block Configuration	133
8	Specification	134

Appendix A – Signal Sources	146
Appendix B – Modbus TCP/Modbus 485	148
B.1 Introduction	148
B.2 Modbus Commands Supported	148
B.3 Modbus Exception Responses	149
B.4 Operating Mode Modbus Coils	150
B.5 Operating Mode Modbus Registers	156
B.6 Communications – Analog and Digital Inputs	158
Appendix C – Storage Capacity	162
C.1 Internal Storage Capacity	162
C.2 External Storage Capacity	162
Appendix D – Units	163
Appendix E – Math Equations	165
E.1 Math Functions	166
E.2 Relative Humidity Calculation	167
E.3 Sterilization Fvalue Calculation	169
E.4 Logarithmic Scales	172
Appendix F – Batch Recording	173
F.1 Introduction	173
F.2 Batch Archive Filenames	173
F.3 Operation	174
F.3.1 Overview	174
F.3.2 Starting a Batch Manually	174
F.3.3 Stopping a Batch Manually	176
F.3.4 Historical Review	176
F.4 Configuration	177
F.4.1 Enabling Batch Security	177
F.4.2 Configuring Batch Access Privileges	178
F.4.3 Batch Configuration	179
Index	181

1 Introduction

1.1 Functional Overview

The recorder features the following functionality:

- 12 Software Recording Channels as standard, divided into 2 Process Groups, each with a maximum of 6 Software Recording Channels.
- 4 Alarms and 2 Totalizers (if Totalizer option is enabled) are assigned to each Recording Channel.
- Signal sources derived from universal analog inputs, Modbus communications, digital inputs or internal analog and digital signals.
- Any source can be assigned to any recording channel.
- Data from assigned sources can be displayed in:
 - Vertical or Horizontal Chart view format
 - Indicator view format with optional integrated Bargraph view
- Three logs record alarm events, totalizer values and system/configuration changes.
- Modbus TCP – communicate with Modbus master and slave devices over an ethernet LAN.
- Modbus (RS485) 2-wire – enables communication with Modbus master devices over a 2-wire RS485 network.
- Screen Capture facility – saves an image of the operator views to external archive media providing external archive media with sufficient free space is inserted in the recorder. It is not necessary for Logging to be 'online'.
- Internal flash memory for the storage of recorded data.
- The ability to archive data to external archive media in either text (*.csv) or binary formats.
- Integrated web server and file transfer protocol (ftp) support for remote monitoring and data acquisition.
- The ability to store batch data (if Batch option is enabled).
- Math and Logic (if Math and Logic option is enabled).

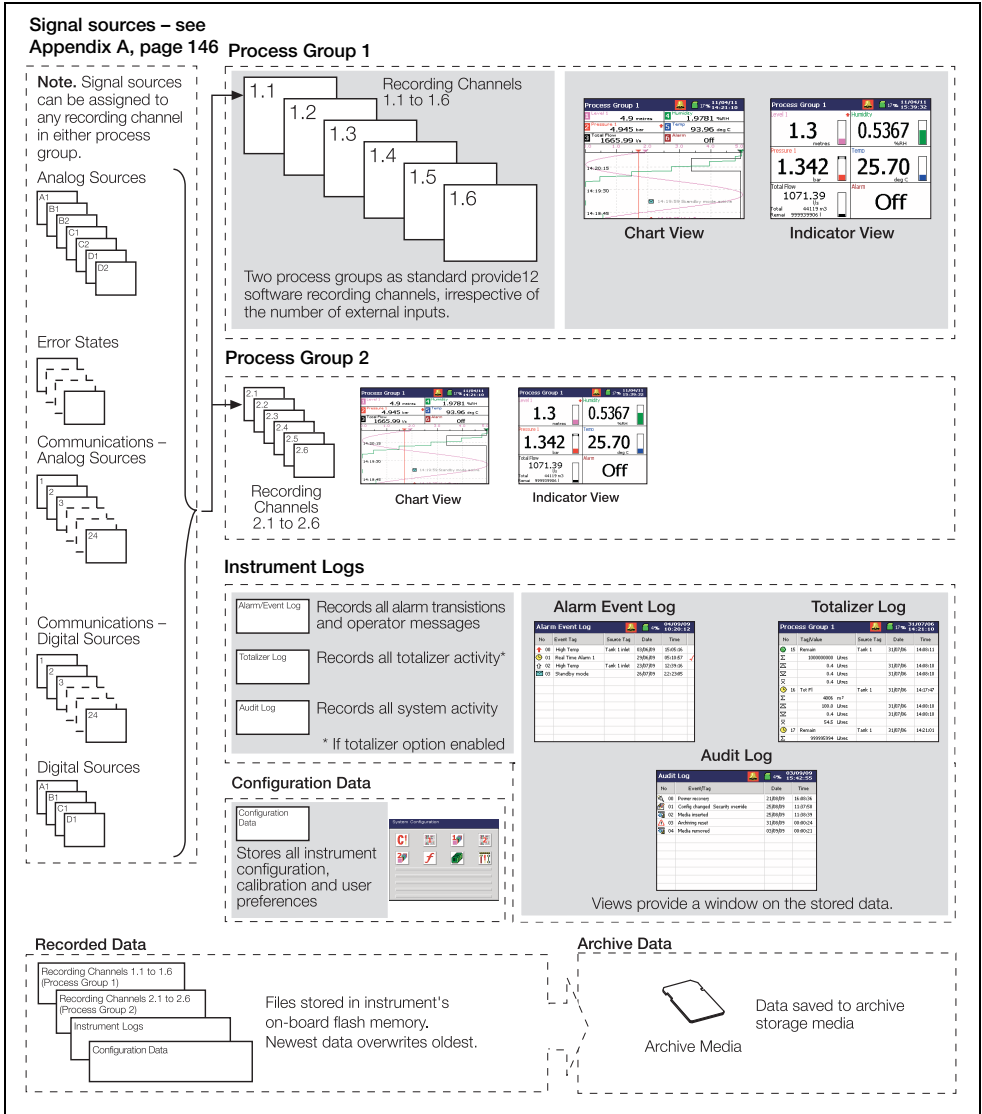

Fig. 1.1 Functional Overview

2 Installation

EC Directive 89/336/EEC

In order to meet the requirements of EC Directive 89/336/EEC for EMC regulations, this product must be used in an industrial environment.

End of Life Disposal

- The recorder contains a small lithium battery that must be removed and disposed of responsibly in accordance with local environmental regulations.
- The remainder of the recorder does not contain any substance that causes undue harm to the environment and must be disposed of in accordance with the Directive on Waste Electrical and Electronic Equipment (WEEE). It must not be disposed of in Municipal Waste Collection.

Cleaning

The complete recorder can be hosed down if it has been installed to IP66/NEMA 4X standards, i.e. cable glands are correctly fitted and all unused cable entry holes are blanked off – see Section 2.3.1, page 15. Warm water and a mild detergent can be used.

2.1 Siting

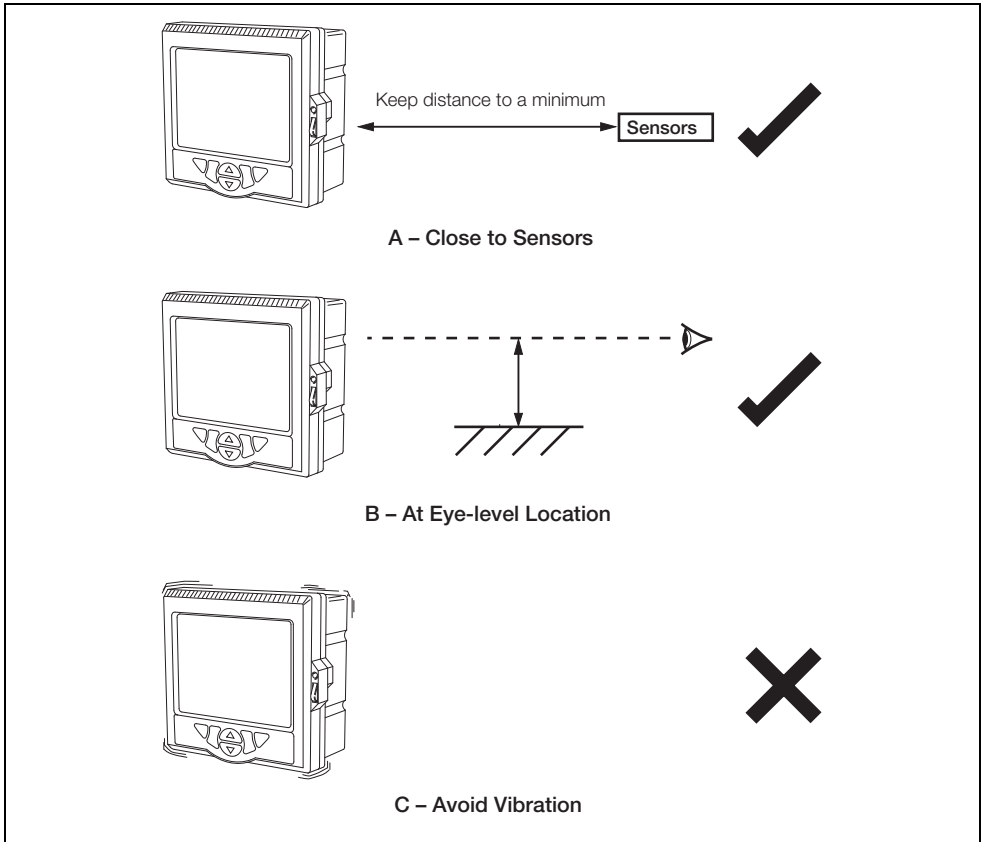

Fig. 2.1 General Siting Requirements

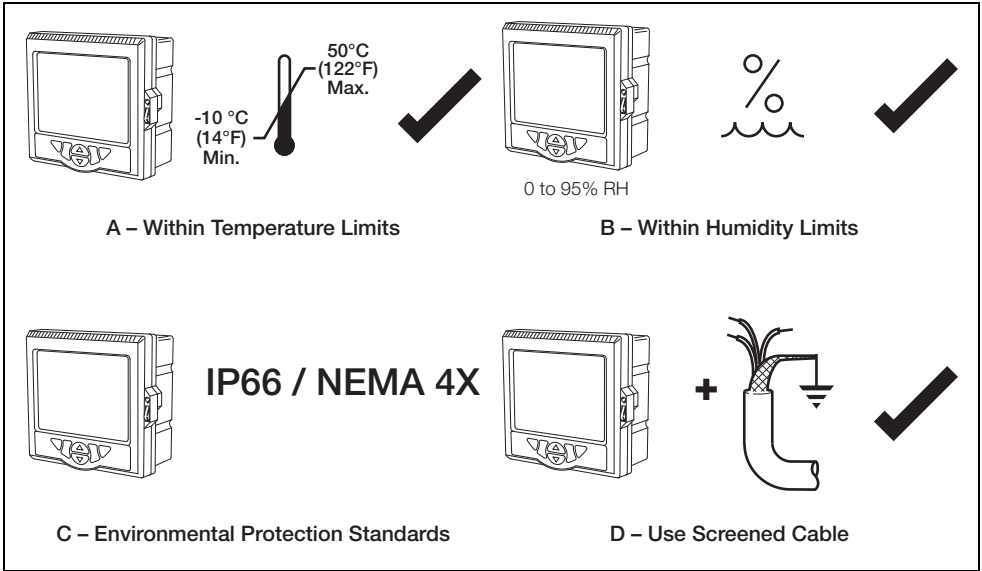

Fig. 2.2 Environmental Requirements

Warning.

- Locate the recorder in a position where its temperature and humidity specification will not be exceeded, and ensure that it is suitably protected from direct sunlight, rain, snow and hail.
- Select a location away from strong electrical and magnetic fields. If this is not possible, particularly in applications where mobile communications equipment is expected to be used, screened cables within flexible, earthed metal conduit must be used.

2.2 Mounting

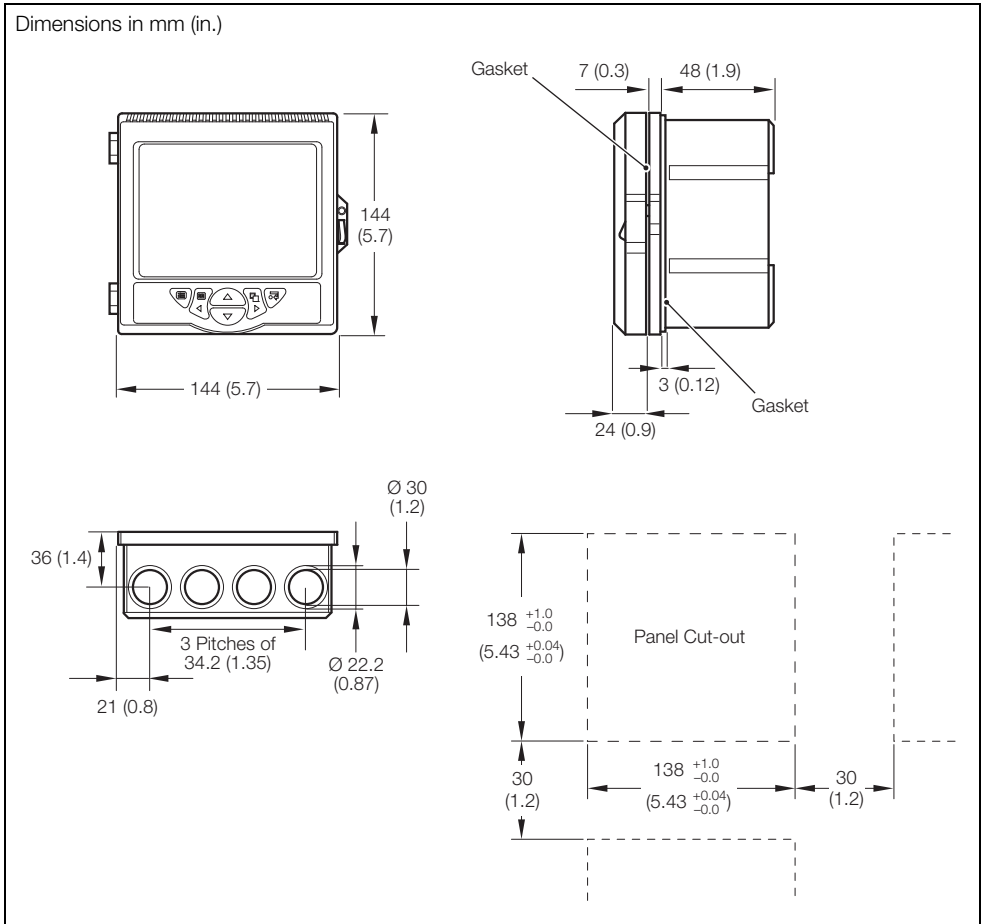

Fig. 2.3 Mounting Dimensions

2.2.1 Panel-Mounting

Note. If removal of knockouts is required, refer to Section 2.3.1, page 15.

Referring to Fig. 2.4, secure the recorder in a panel as follows:

- ① Cut the correct sized hole in the panel – see Fig. 2.3, page 10.
 - ② Insert the recorder into the panel cut-out.
 - ③ Screw one clamping screw into the left-hand bracket until 10 to 15mm of the thread protrudes from the other side of the bracket and position one clamp over the end of the thread.
 - ④ Holding the assembly together, position the bracket into the left-hand recess on the rear of the recorder case and secure with the bracket securing screw. Ensure that the plastic washer remains in the position fitted.
- Repeat instructions ③ and ④ for the right-hand panel clamp assembly.
- ⑤ Tighten the clamping screws evenly and securely by hand.

Note. This is critical in order to ensure proper compression of the panel seal and achieve the IP66/NEMA 4X hosedown rating.

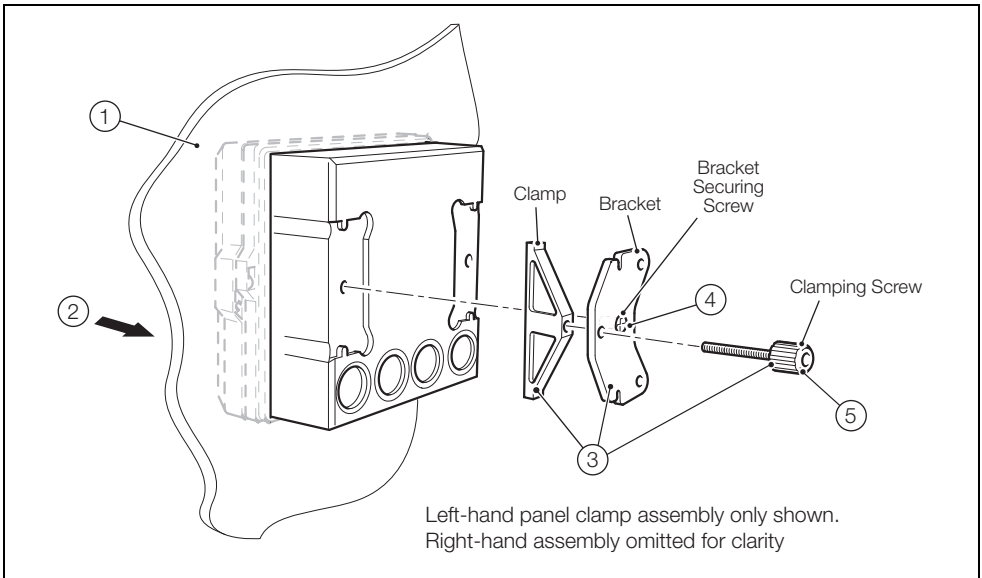

Fig. 2.4 Installing the recorder – Panel-Mounting

2.2.2 Wall-Mounting

Note. If removal of knockouts is required, refer to Section 2.3.1, page 15.

Referring to Fig. 2.5, secure the recorder to a wall as follows:

- ① Position the left- and right-hand mounting brackets into the recesses on the rear of the recorder as shown and secure with the bracket securing screws. Ensure the plastic washers remain in the positions fitted.
- ② Mark fixing centers and drill suitable holes in the wall.
- ③ Secure the recorder to the wall using 2 screws in each mounting bracket.

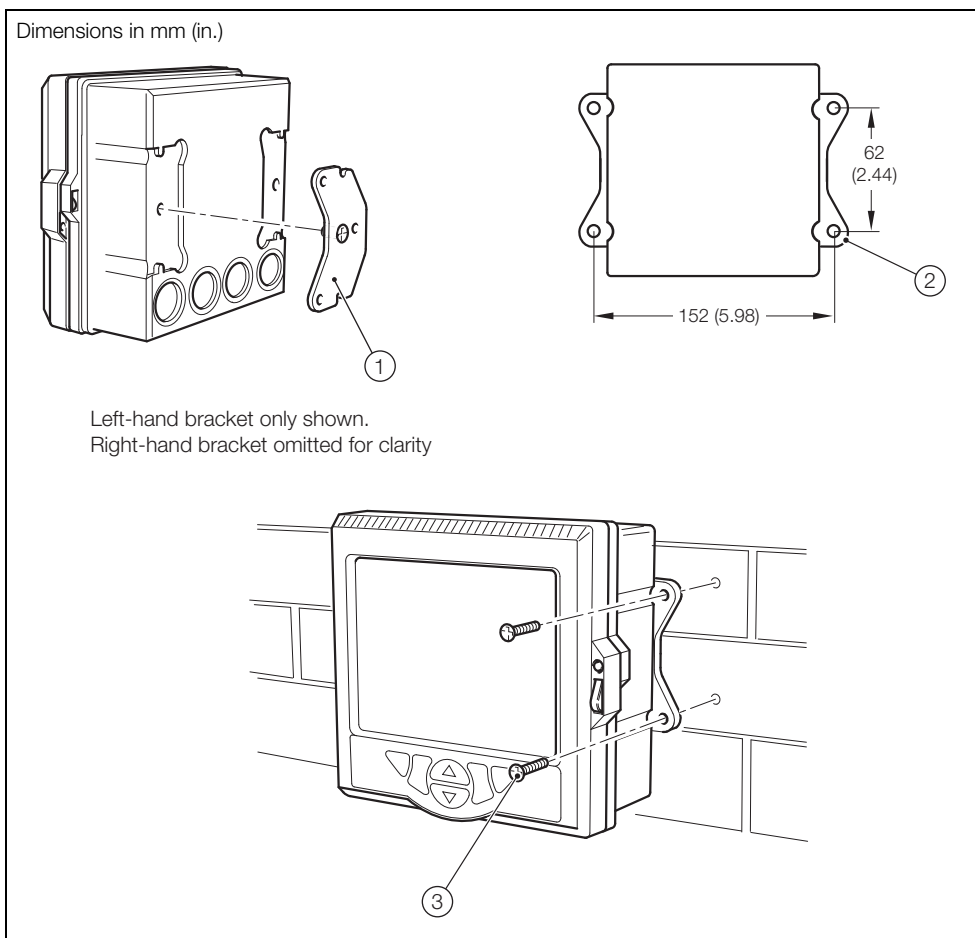

Fig. 2.5 Installing the Recorder – Wall-Mounting

2.2.3 Pipe-Mounting (Optional)

Note. If removal of knockouts is required, refer to Section 2.3.1, page 15.

Referring to Fig. 2.6, secure the recorder to a pipe as follows:

- ① Fit two M6 x 50mm long hexagon-head screws through one clamp plate as shown.
- ② Using the appropriate holes to suit vertical or horizontal pipe, secure the clamp plate to the pipe-mounting bracket using the two M6 x 8mm long hexagon-head screws and two of the spring lock washers.
- ③ Position the pipe mounting bracket into the recesses on the rear of the recorder as shown and secure with the two bracket securing screws. Ensure the plastic washers remain in the positions fitted.
- ④ Secure the recorder to the pipe using the remaining clamp plate, spring lock washers and nuts.

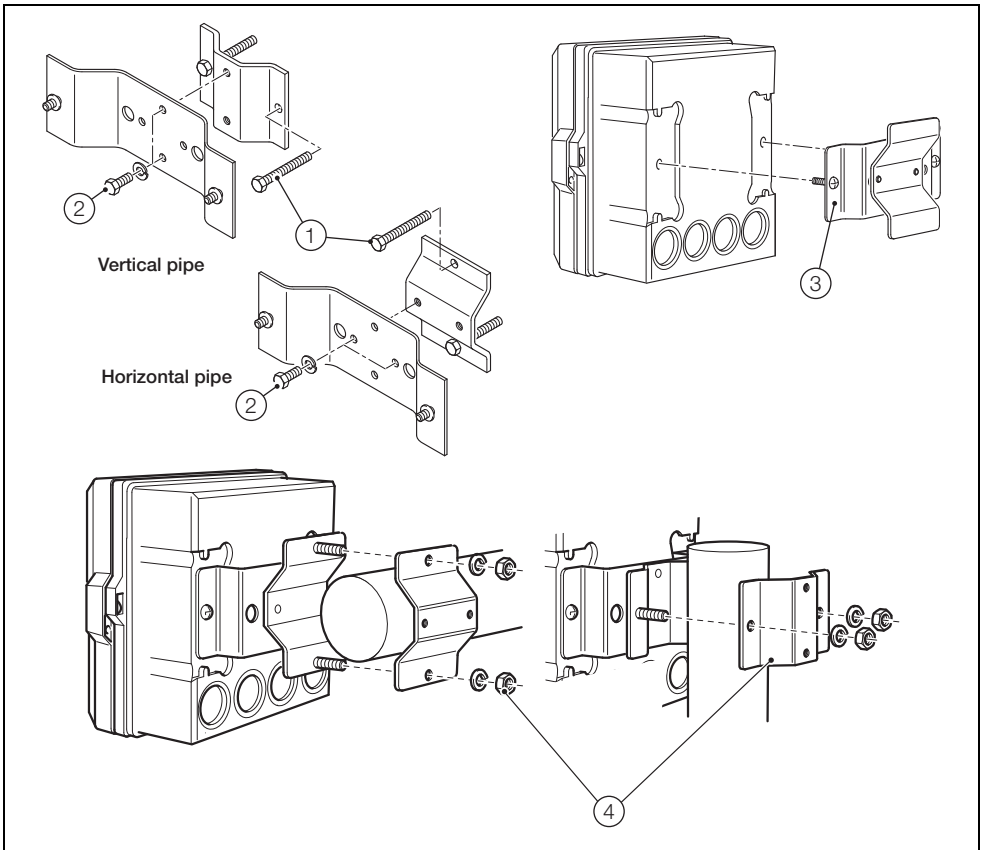

Fig. 2.6 Installing the Recorder – Pipe-Mounting (Optional)

2.3 Electrical Connections

Warning.

- The recorder is not fitted with a switch therefore a disconnecting device such as a switch or circuit breaker conforming to local safety standards must be fitted to the final installation. It must be fitted in close proximity to the recorder within easy reach of the operator and must be marked clearly as the disconnection device for the recorder. A fuse must be fitted in accordance with Fig. 2.11.
- Remove all power from supply, relay and any powered control circuits and high common mode voltages before accessing or making any connections.
- Use cable appropriate for the load currents: 3-core cable rated 3 A and 90 °C (194 °F) minimum, that conform to either IEC 60227 or IEC 60245. The terminals accept cables from 0.8 to 2.5 mm² (18 to 14 AWG).
- The recorder conforms to Installation Category II of IEC 61010.
- All connections to secondary circuits must have basic insulation.
- After installation, there must be no access to live parts, for example, terminals.
- Terminals for external circuits are for use only with equipment with no accessible live parts.
- If the recorder is used in a manner not specified by the Company, the protection provided by the equipment may be impaired.
- All equipment connected to the recorder's terminals must comply with local safety standards (IEC 60950, EN601010-1).

Note.

- Always route signal leads and power cables separately, preferably in earthed (grounded) metal conduit.
- Use screened cable for signal inputs and relay connections.
- Replacement of the internal battery (type Varta CR2025 3V lithium cell) must be carried out by an approved technician only.

USA and Canada only

- The supplied cable glands are provided for the connection of signal input and ethernet communication wiring only.
- The supplied cable glands and use of cable/flexible cord for connection of the mains power source to the mains input and relay contact output terminals is not permitted in the USA or Canada.
- For connection to mains input and relay contact outputs), use only suitably rated field wiring insulated copper conductors rated min. 300 V, 14 AWG, 90C. Route wires through suitably rated flexible conduits and fittings.

2.3.1 Cable Entries

Referring to Fig. 2.7, page 16:

- ① Route cables through the four holes provided on the bottom of the case.
- ② Knockouts are provided on the rear of the recorder case as an alternative means of cable entry. To remove a knockout, place the back of the recorder on a firm, flat surface, open the door and inner cover (see Fig. 7.3, page 68) and carefully remove the knockout by placing the blade of a small, flat-bladed screwdriver into the knockout groove and tapping the screwdriver smartly with a hammer.
- ③ Use the indicated cable entry hole or knockout if the optional Ethernet module is fitted.
- ④ Connect the Ethernet cable, ensuring that if optional input modules are fitted in positions B and C, the cable is routed between their terminal blocks as shown.
- ⑤ Connect cable screens only to the terminals indicated.

Note.

- For wall- or pipe-mounting to IP66/NEMA4X standard, fit suitable cable glands. Blank off any unused holes with the blanking plugs and retaining clips supplied with the recorder.
- Optional cable glands are available and are suitable for use with cables Ø 5 to 9mm (0.20 to 0.35 in.). The alternative 2-hole cable gland inserts are suitable for use with cables Ø 5mm (0.20 in.). The Ethernet cable gland is suitable for use with cable Ø 4.8 to 6.3mm (0.19 to 0.25 in.).

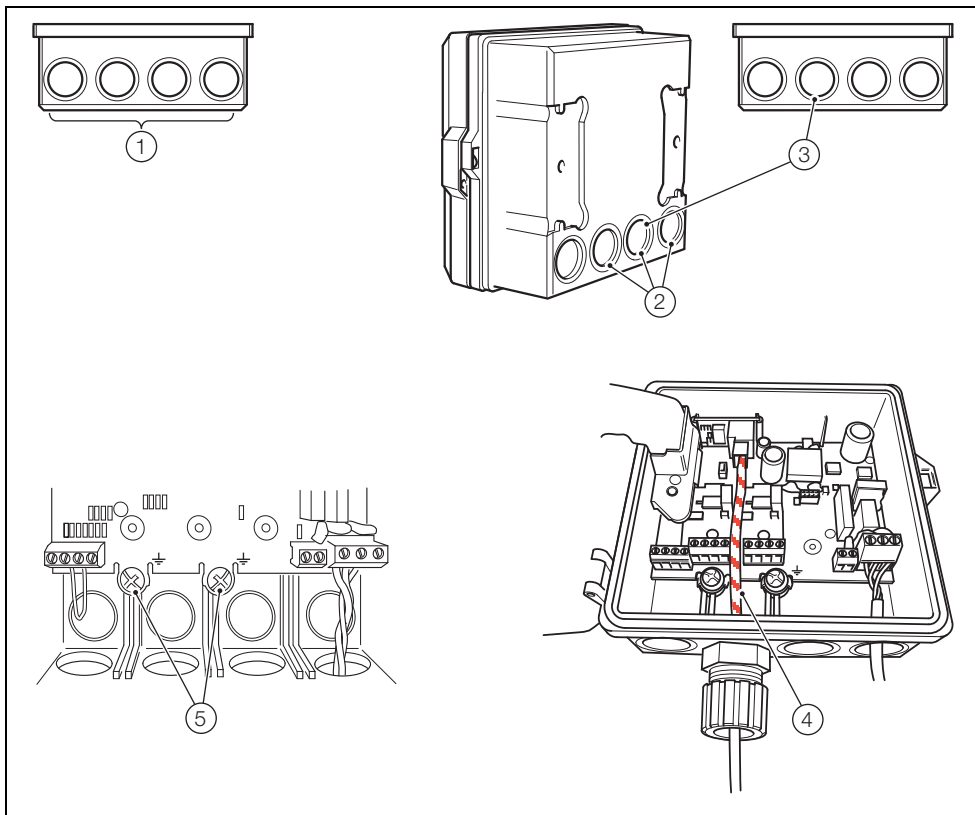

Fig. 2.7 Cable Knockouts, Ethernet Cable Routing and Cable Screening Connections

2.3.2 Connections

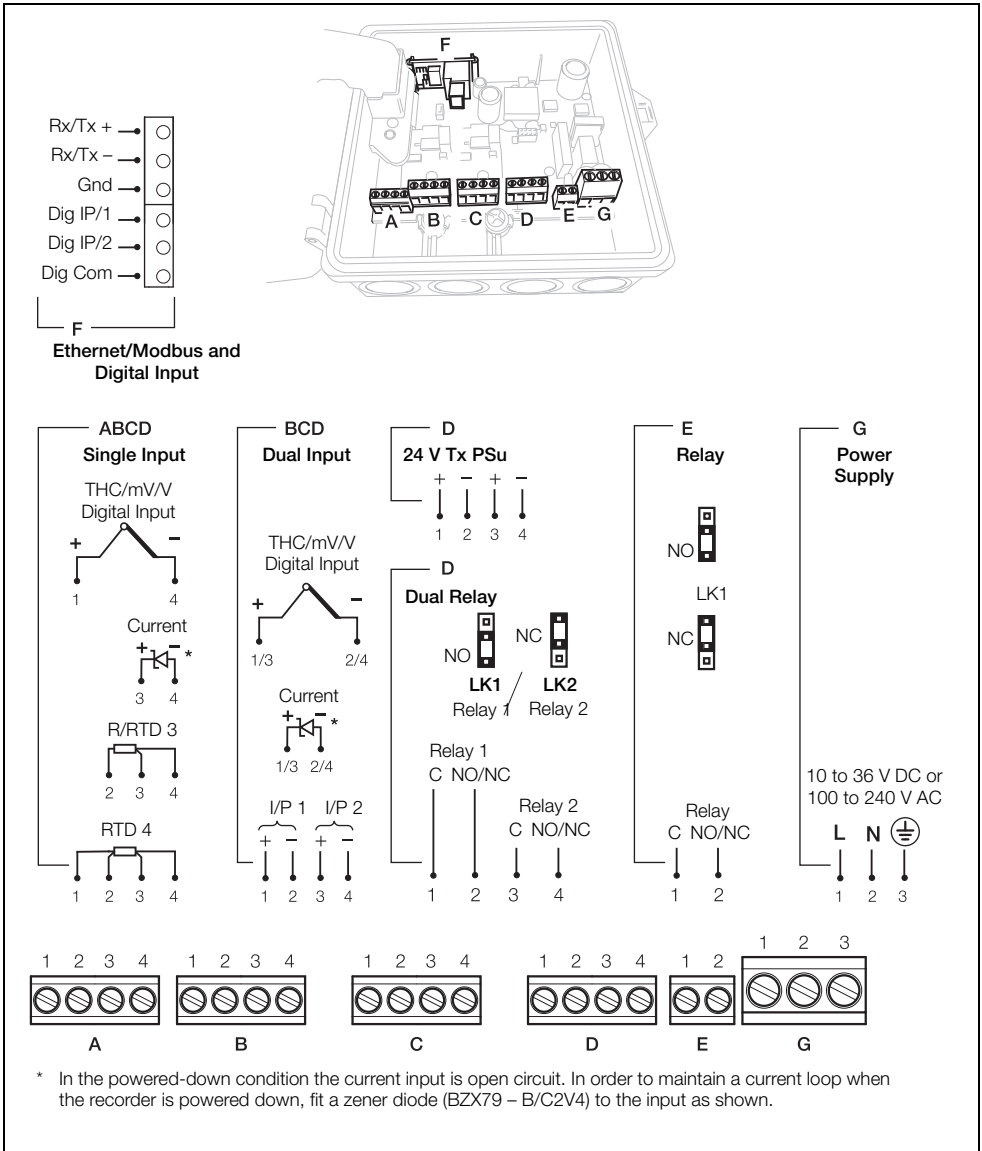

Fig. 2.8 Electrical Connections

Note. Power supply terminal screws must be tightened to a torque of 0.8 Nm (7 lbf.in). All other terminal screws must be tightened to a torque of 0.5 Nm (4.5 lbf.in).

2.4 Single Analog/Digital Inputs

2.4.1 Thermocouple

Use the correct compensating cable between the thermocouple and the terminals – see Table 2.1, page 20.

Automatic cold junction compensation (ACJC) is incorporated but an independent cold (reference) junction may be used.

2.4.2 Resistance Thermometer (RTD)

On applications requiring long leads it is preferable to use a 3-lead resistance thermometer.

If 2-lead resistance thermometers are used, each input must be calibrated to take account of the lead resistance.

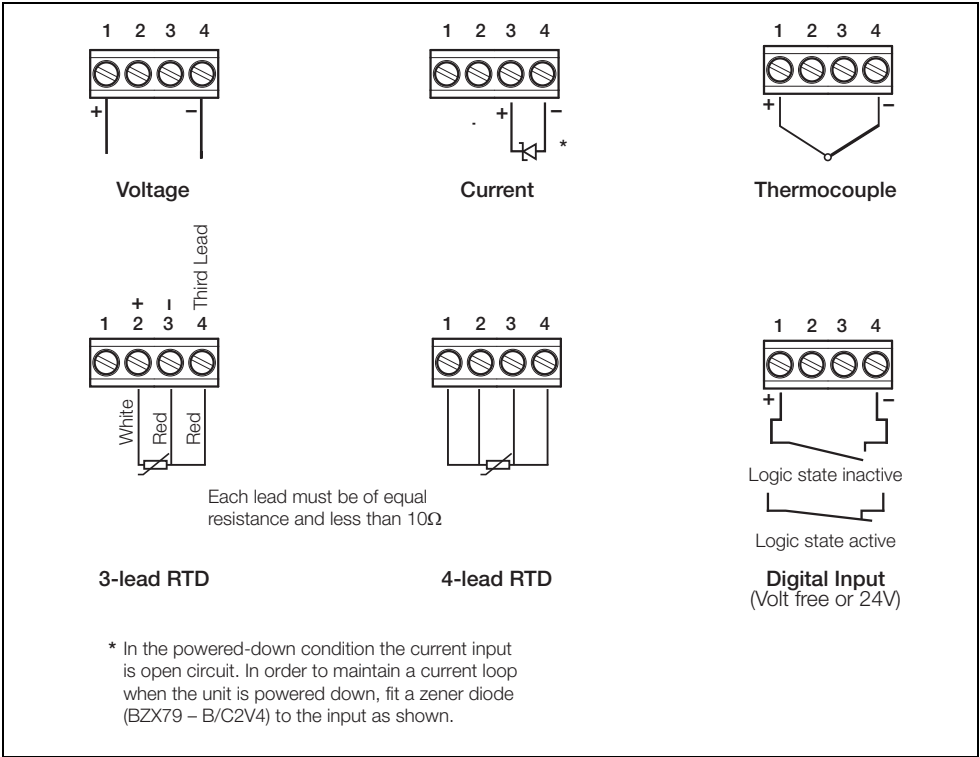

Fig. 2.9 Single Analog/Digital Input Connections

Note. Analog/digital input terminal screws must be tightened to a torque of 0.5 Nm (4.5 lbf.in).

2.5 Dual Analog/Digital Inputs

2.5.1 Thermocouple

Use the correct compensating cable between the thermocouple and the terminals – see Table 2.1, page 20.

Automatic cold junction compensation (ACJC) is incorporated but an independent cold (reference) junction may be used.

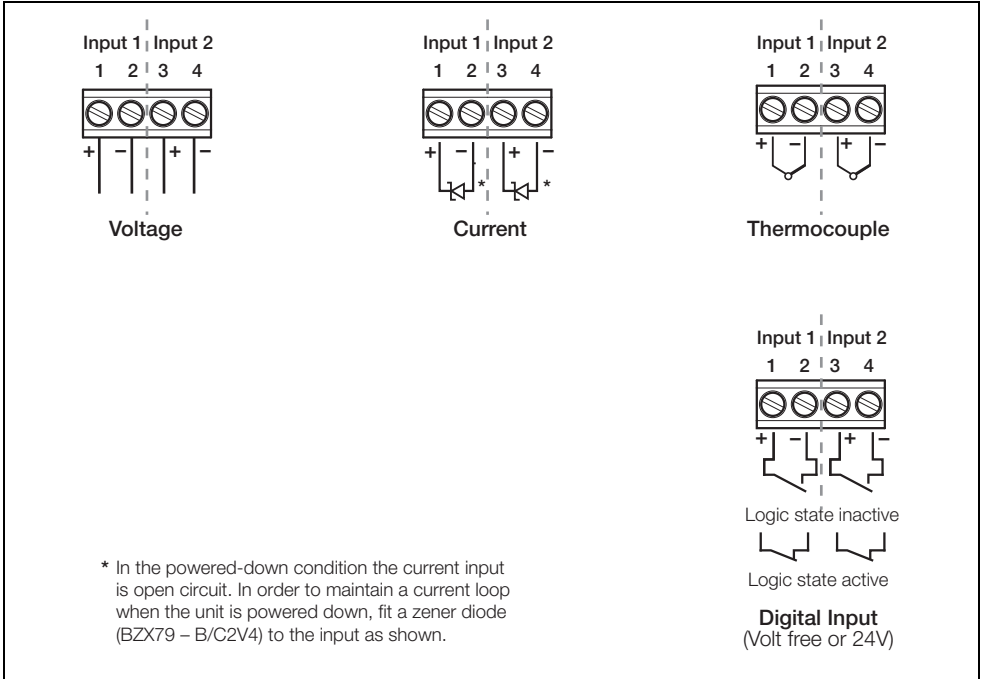

Fig. 2.10 Dual Analog/Digital Input Connections

Note. Analog/digital input terminal screws must be tightened to a torque of 0.5 Nm (4.5 lbf.in).

Thermocouple Type	Compensating Cable											
	BS1843			ANSI MC 96.1			DIN 43714			BS4937 Part No.30		
	+	-	Case	+	-	Case	+	-	Case	+	-	Case
Ni-Cr/Ni-Al (K)	Brown	Blue	Red	Yellow	Red	Yellow	Red	Green	Green	Green	White	Green *
Ni-Cr/Cu-Ni (E)	-			-			-			Violet	White	Violet *
Nicrisil/Nisil (N)	Orange	Blue	Orange	Orange	Red	Orange	-			Pink	White	Pink *
Pt/Pt-Rh (R and S)	White	Blue	Green	Black	Red	Green	Red	White	White	Orange	White	Orange *
Pt-Rh/Pt-Rh (B)	-			-			-			Grey	White	Grey *
Cu/Cu-Ni (T)	White	Blue	Blue	Blue	Red	Blue	Red	Brown	Brown	Brown	White	Brown *
Fe/Con (J)	Yellow	Blue	Black	White	Red	Black	Red	Blue	Blue	Black	White	Black *
* Case Blue for intrinsically safe circuits												
Fe/Con (DIN 43710)	-			-			DIN 43710			-		
							Blue/red	Blue	Blue			

Table 2.1 Thermocouple Compensating Cable

2.6 Power Supply Connections

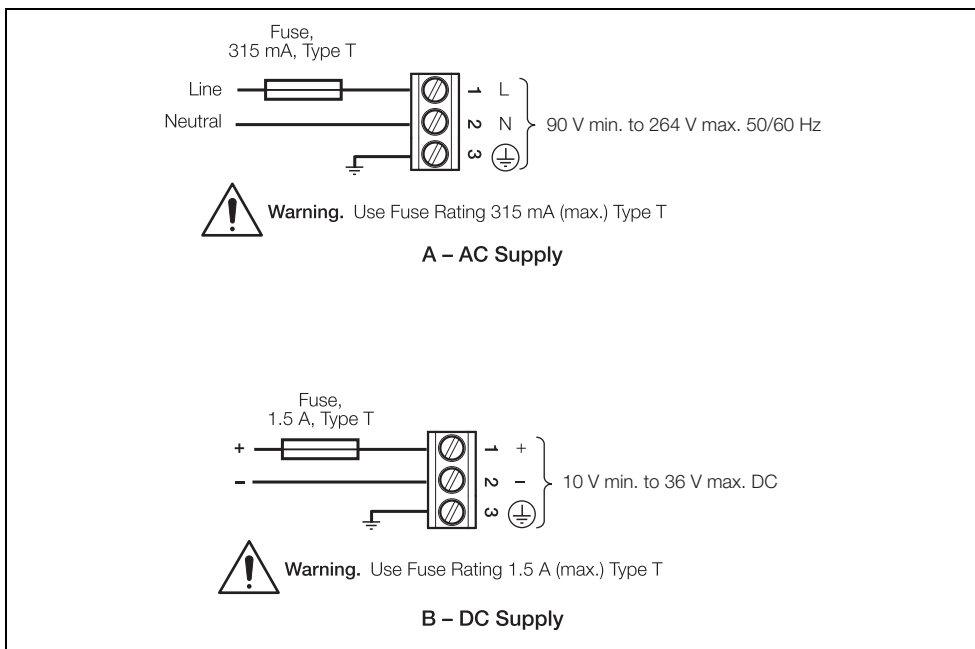

Fig. 2.11 Power Supply Connections

Note. Power supply terminal screws must be tightened to a torque of 0.8 Nm (7 lbf.in).

2.7 Transmitter Power Supply Module

One transmitter power supply module can be fitted in position D to provide a nominal 24V supply capable of driving two, 2-wire transmitters.

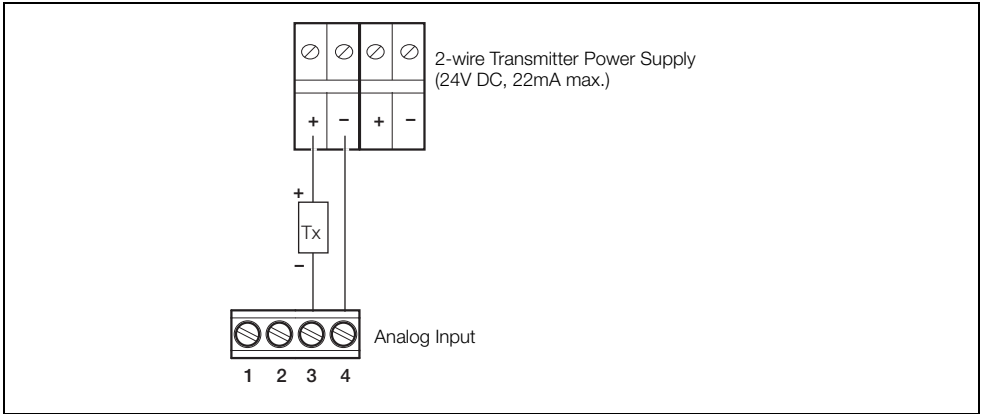

Fig. 2.12 Transmitter Power Supply Module

Note. Analog input terminal screws must be tightened to a torque of 0.5 Nm (4.5 lbf.in).

2.8 Relays

One relay is provided as standard (position E). An additional relay module can be fitted in position D to provide two additional relays.

The maximum individual relay current is 5A.

Relay contacts are fitted with arc suppression components as standard.

Set the polarity using the relay links provided on the recorder's motherboard (for the standard relay) and the relay module board (for the optional additional relays) – see Fig. 2.8, page 17.

2.9 Modbus/Digital Input

A Modbus/digital input module can be fitted in position F to provide a 2-wire isolated RS485 interface and 2 digital inputs.

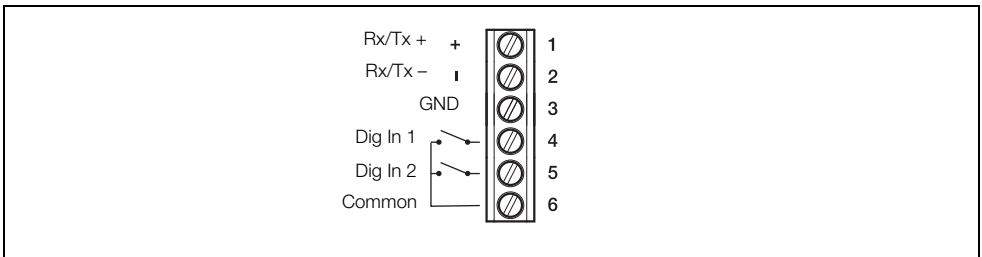

Fig. 2.13 Modbus/Digital Input Module

2.9.1 Host Computer Serial Communications

The serial interface option module has been designed to operate using the Modbus Remote Terminal Unit (RTU) Master/Slave protocol. An appropriate RS422/485 communications driver must be fitted to the host (Master) computer. It is strongly recommended that the interface has galvanic isolation to protect the computer from lightning damage and to increase signal immunity to noise pick-up.

2.9.2 Two-wire Connection

Modbus serial communications must be configured as two-wire serial links – see Fig. 2.14. The instrument must be added to the link configuration on the host system – refer to information supplied with the host system.

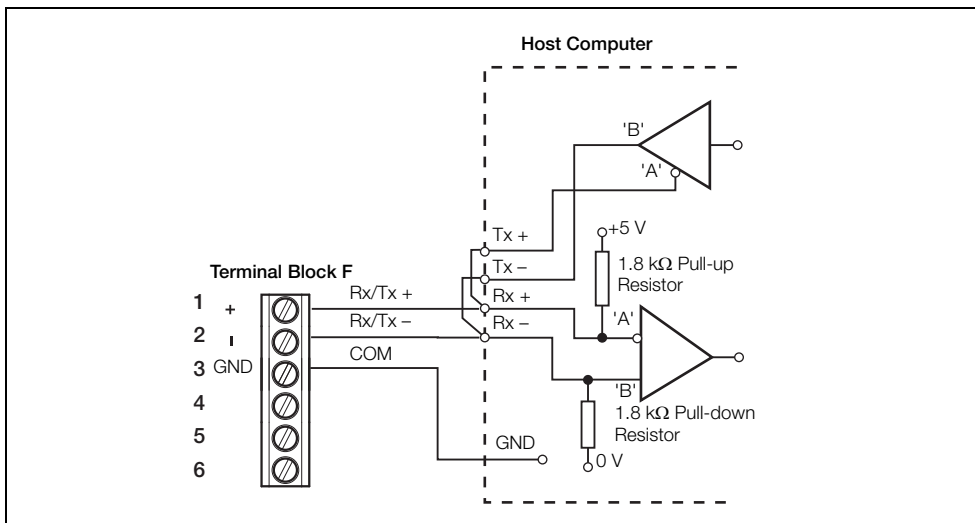

Fig. 2.14 Two-wire Connection

2.9.3 Pull-up and Pull-down Resistors

To prevent false triggering of slaves when the master (host computer) is inactive, pull-up and pull-down resistors are fitted to the SM500F's Modbus/digital input module.

2.9.4 Termination Resistor

For long transmission lines, a termination resistor must be fitted to the last slave in the chain – see Fig. 2.15.

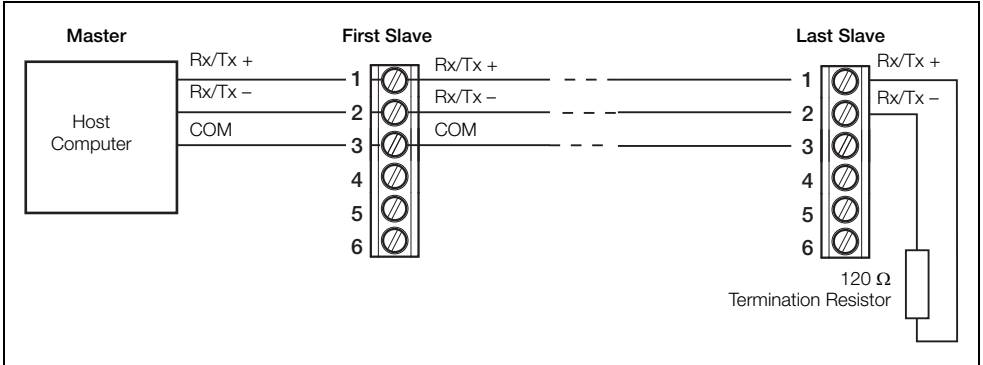

Fig. 2.15 Connecting Multiple Slaves

2.9.5 Serial Connections













Connections to the Modbus serial board must be made as shown in Fig. 2.14. Connections to two-wire systems with multiple slaves must be made in parallel as shown in Fig. 2.15. When connecting cable screens, ensure that 'ground loops' are not introduced.

The maximum serial data transmission line length for both RS485 systems is 1200m. The types of cable that can be used are determined by the total line length:

- Up to 6m – standard screened or twisted pair cable.
- Up to 300m – twin twisted pair with overall foil screen and an integral drain wire.
- Up to 1.2km – twin twisted pair with separate foil screens and integral drain wires.

3 On-Line Help

The recorder is equipped with a context-sensitive, on-line help facility that can be accessed from any operator, logging or configuration view. To navigate the on-line help, refer to Fig. 3.1 and:

- ① Select 'Help' from the menu and press the  key. The help index opens automatically at the help page relevant to the view from which help was selected – in this instance, the alarm configuration view.
- ② Press the  and  keys to move the selection up and down through the index. Press the  key to view the selected help file and use the  and  keys to scroll through it.
- ③ Highlight a section icon () . If it changes to the  icon, there is a help file () directly associated with selected section – press the  key to open it.
- ④ If the section icon remains closed, the section it represents contains sub-sections and files. Press the  key to open the section and reveal the sub-sections. Repeat the process for sub-sections. Press the  key to close a sub-section or section.

To exit the on-line help, press the  key repeatedly to return to the screen from where help was first selected.

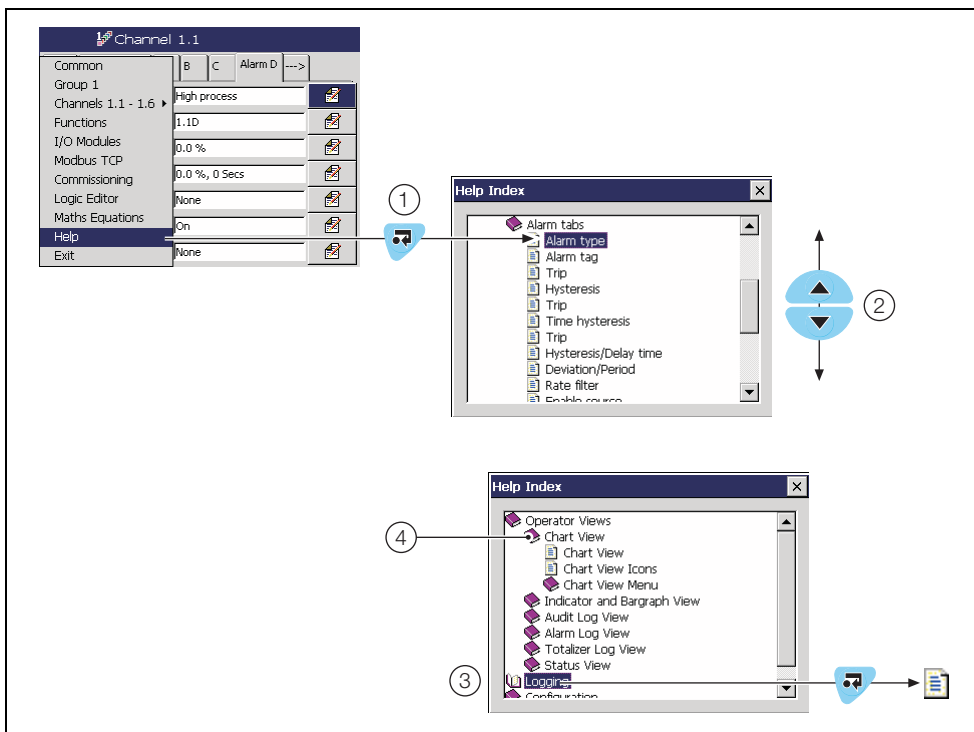

Fig. 3.1 On-Line Help Overview

4 Operation

4.1 Powering up the Recorder









When power is first applied to the recorder, its processor carries out a number of self-tests and displays the start-up screen.

At the end of the start-up sequence, the recorder displays the Operator view that was being displayed when the recorder was powered down.

4.2 Operator Keys and Door Features

The recorder is operated via the Operator Keys located below the screen.

Referring to Fig. 4.1, operator keys and door features are located as follows:

- ①  **Menu Key** – Displays or hides the context-sensitive operator menu associated with each view. Also cancels the menu without making a change or returns to the previous menu level.
- ②  **Group Key** – Selects a different process group or
 **Left Key** – Scroll left.
- ③  **Up/Down Keys** – Highlights menu items and scrolls through previously recorded data.
- ④  **View Key** – Selects a different process view or log or
 **Right Key** – Scroll right.
- ⑤  **Enter Key** – Selects the highlighted menu item.
- ⑥ If 'Screen Capture' is set to 'Enabled' during configuration (see Section 7.6.1, page 74) **and** a Secure Digital (SD) archive media card is inserted in the recorder, the operator can save a snapshot of any an image of any Chart, Indicator, Audit Log, Alarm Log or Totalizer Log view to the SD card if  is pressed when an operator menu is not displayed.
- ⑦ **Door Release.**
- ⑧ **Door Lock (optional).**

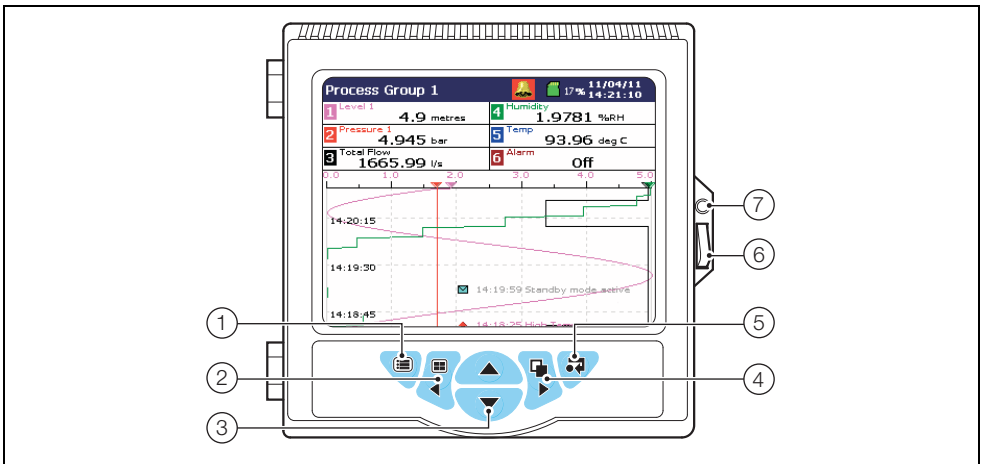

Fig. 4.1 Operator Keys and Door Features

4.3 Operator Display Overview

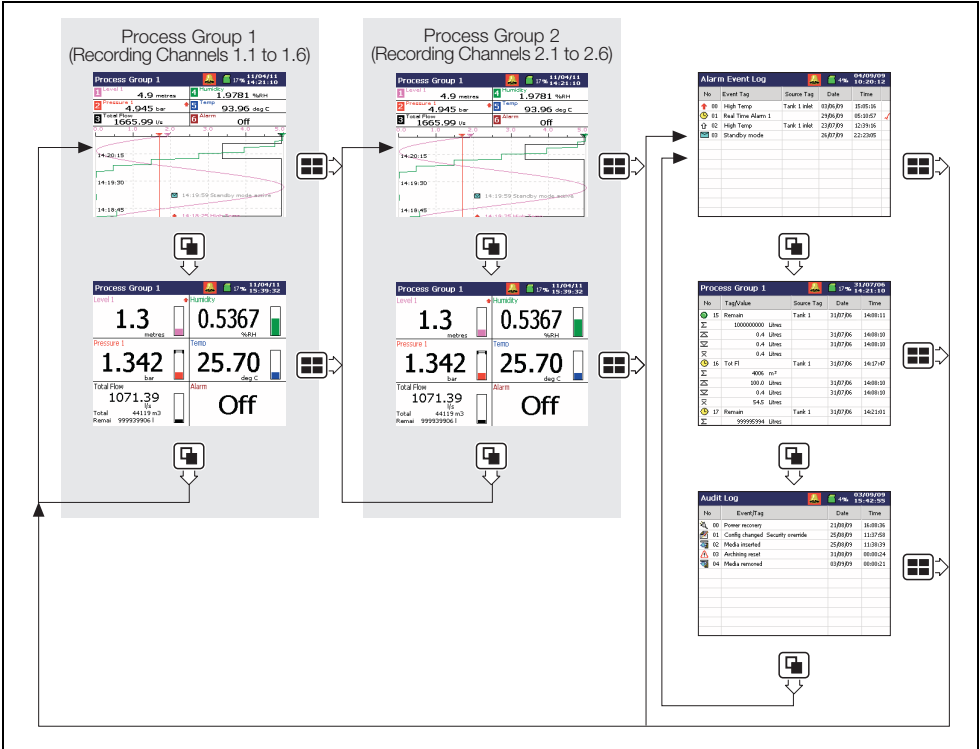

Fig. 4.2 Overview of Operator Displays

Note. Only process groups and views that are enabled are displayed.

4.4 Chart Views

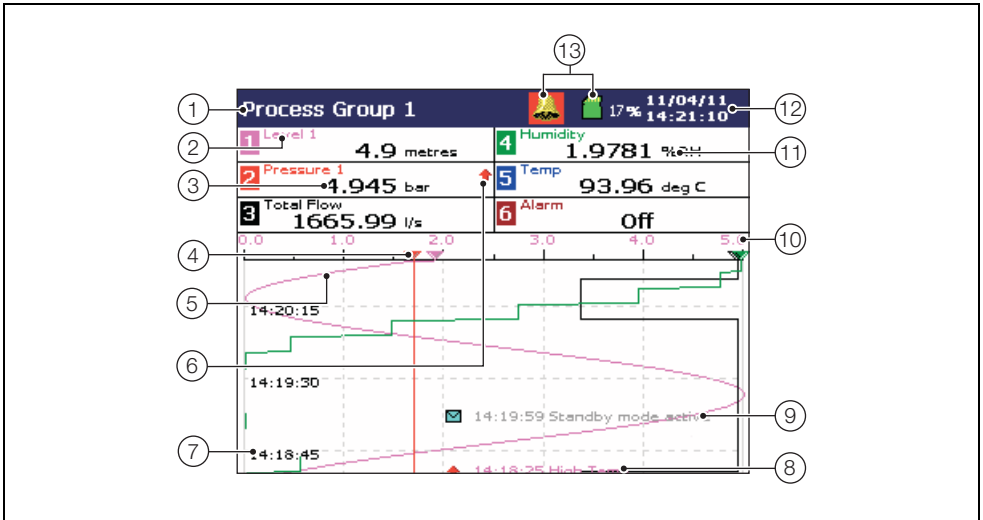



Fig. 4.3 Horizontal and Vertical Chart Views

Key to Fig. 4.3:

- ① Process group name.
- ② Channel tag.
- ③ Current value – see **Note 1**, page 28.
- ④ Trace pointer – see **Note 2**, page 28.
- ⑤ Channel trace – see **Note 2**, page 28.
- ⑥ Alarm icon.
- ⑦ Time stamp.
- ⑧ Alarm event annotation – see **Note 3**, page 28.
- ⑨ Operator message annotation – see **Note 3**, page 28.
- ⑩ Scale bar.
- ⑪ Engineering units.
- ⑫ Current date and time.
- ⑬ Status icons – see **Note 4**, page 28.

Note.

- Do not remove media while the media update in progress status icon () is displayed.
- Always set the external media Off-line before removing it – see page 51.

Note.**1. Current Values**

The Current Value is the latest instantaneous value and its update rate is not affected by the recording sample rate.

If the current value is displayed in red (color recorders) or white on a black background (monochrome recorders), recording has been stopped for that channel – see Section 5.2, page 50 and see Section 7.8.1, page 93.

Traces are displayed only when recording is active for that process group. If recording is set to **Stop**, the traces continue to be displayed for up to one sample period and are then turned off.





2. Trace Pointers and Channel Traces

On color recorders, the trace pointers and channel traces are displayed in the color assigned to each channel. On monochrome recorders, the trace pointer is numbered to indicate the channel number of each channel trace. Trace pointers may be disabled during configuration (see Section 7.7.2, page 87) but on a monochrome recorder, this will make individual trace identification difficult.

3. Alarm Event, Operator Message and Electronic Chart Signature Annotations

Alarm Event, Operator Message and Electronic Chart Signature annotations are not shown on the chart unless enabled – see 'Chart Annotation', page 33 and Section 7.7.2, page 87.

If Alarm event annotation is enabled and an alarm becomes active, a alarm event icon is displayed at the point at which the alarm occurred, together with the alarm time and tag, e.g.



    11:58:00 1.1A High Level

If more than one alarm occurs in the same sample period:

- and a second alarm on a channel becomes active, its icon is added behind the first.
- and more than one operator message is active (max. 24), a second icon is added behind the first.
- the new alarm event icons appear to the left of earlier icons.
- the time and tag of the oldest alarm (right-most icon) only is displayed.

4. Alarm Status

- Flashing alarm event icon – alarm active and unacknowledged
- Continuous alarm event icon – alarm active and acknowledged

If **any** alarm in **either** process group is active, the Global Alarm status icon () is displayed in the status bar – see Fig. 4.3. If **any** active alarm in **either** process group is unacknowledged, the icon is surrounded by a flashing border ()



Configuration ▶

Select the Configuration Level – see Section 7, page 65.

Logging ▶

Select the Logging Level – see Section 5.1, page 47.

Sign Chart ▶

Note. Available only if 'Security system' is set to 'Advanced' (see Section 7.6.4, page 78) and the user's access privileges include 'e-Sign' (see page 82).

Sign the chart electronically – see Section 4.4.1, page 37.

Historical Review

Select to view previously recorded data for the displayed group stored in the recorder's onboard memory.

Note.

- Use the ▲ and ▼ keys to move backwards and forwards through the recorded data.
- Previously recorded data for the other group can be viewed if the group is enabled and displayed.

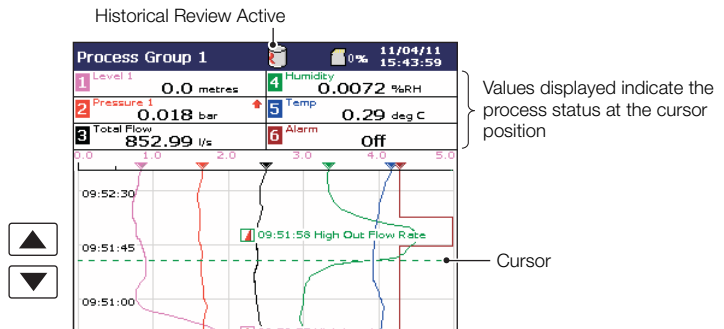

Note.

While in Historical Review mode:

- Recording of new data continues unless stopped from the Logging Menu – see Section 5.1, page 47.
- The current value is replaced by '- - -' when the historical data is invalid (e.g. when recording was stopped).
- Where the trace at the cursor position represents more than one sample, the indicators flash between the maximum and minimum values of those samples.
- Menu options remain active – allowing the screen interval to be changed, different scales and channels to be selected, etc.
- Operator messages generated are added to the alarm event log at the present time, not the time indicated by the cursor.
- All data stored in the recorder's internal memory can be viewed.
- The display can be scrolled back to the start of the oldest data.
- Archiving to removable media is suspended but all data recorded in the internal memory buffer during this time is archived automatically on exiting Historical Review mode.

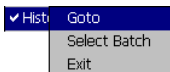

Select to move to data stored in the recorder's onboard memory that was recorded at a specific date and time.

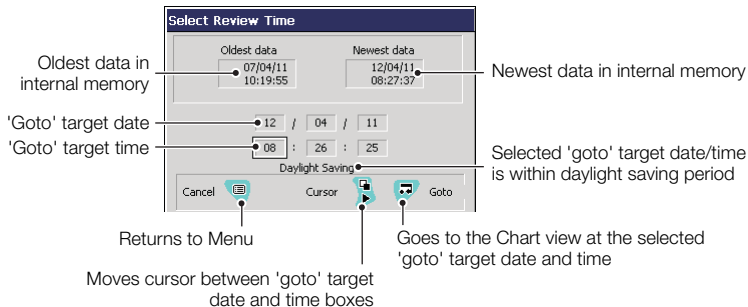

Note.



- If daylight saving is enabled (see Section 7.6.3, page 76) **and** the selected 'Goto' target date/time is within the daylight saving period, 'Daylight Saving' is displayed on the dialog box.
- Once internal memory becomes full, the oldest data is overwritten by the newest data. If historical review has been selected for some time, the oldest data present may no longer be available.
- The recorder exits Historical Review mode automatically after 15 minutes if no key is pressed.



Select to move to data recorded in the instrument's onboard memory for a specific batch – see Appendix F.3.4, page 176.



Select to return to the real-time recording display.

Note. Pressing the  or  keys also exits Historical Review mode and displays the next enabled view or group respectively.



Select to add one of 24 predefined Operator Messages (see Section 7.6.6, page 83) or one User-Defined Message to the alarm event log.

If '< user defined >' is selected, a data entry keyboard appears to enable the message to be entered (see Fig. 7.6, page 71).

The selected or user-defined message is displayed briefly on screen. If 'Operator Messages' annotation is selected (see 'Chart Annotation' below) the message is also added to the chart.

Note. When the recorder is in Historical Review mode, Operator Messages generated are added at the current time, not the time indicated by the cursor.

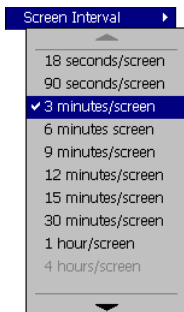

Select to change the amount of data displayed on the screen. A longer screen interval displays more data, a shorter screen interval displays data over a shorter time period, but in more detail. In both cases, the full trace is preserved by plotting the maximum and minimum samples for each display point.

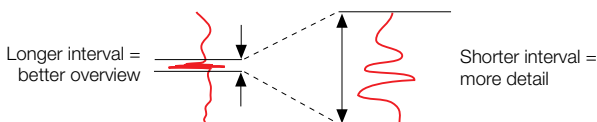

The screen intervals available in the menu are determined by the faster of the primary and secondary sample rates set for the process group during configuration – see Section 7.7.1, page 84. Unavailable screen intervals are greyed-out in the menu (color recorders) or are blanked-out when selected in the menu (monochrome recorders).

Table 4.1 shows the relationship between sample rate and screen interval for the Vertical and Horizontal Chart views.

Note.

- A 'Please Wait' message appears in the status bar while the recorder retrieves data from storage.
- Selecting a different screen interval does not affect the rate at which data is sampled.
- When in historical review mode, changing the screen interval causes the time at the cursor position to change.

Sample Rate Setting	Maximum Screen Interval	
	Vertical Chart View	Horizontal Chart View
<1 second	Up to 1 hour/screen	Up to 1.5 hours/screen
More than 1 second, less than 4 seconds	Up to 12 hours/screen	Up to 21 hours/screen
More than 4 seconds, less than 8 seconds	Up to 1 days/screen	Up to 1.5 days/screen
More than 8 seconds, less than 12 seconds	Up to 2 days/screen	Up to 3 days/screen
More than 12 seconds, less than 28 seconds	Up to 3 days/screen	Up to 4.5 days/screen
More than 28 seconds	Up to 7 days/screen	Up to 12 days/screen

Table 4.1 Sample Rates and Screen Intervals



If an alarm or operator message is obscuring part of a chart trace, select the Chart Annotation option to hide or display alarms and messages on the screen. Select the annotation required. ✓ indicates the annotations selected.

Note.

- If more than 15 icons are present on the screen, chart annotation is disabled automatically.
- If chart annotation is disabled, new operator messages and alarms are still added to the Alarm Event log – see Section 4.7, page 43.

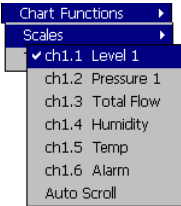

Select a channel scale to be displayed in the scale bar at the top of the chart window. For digital channels, the On and Off tags are displayed at the corresponding position on the scale bar.

Select 'Auto Scroll' to display the scale for each enabled channel in turn for 36 seconds.



Hide individual channel traces to improve chart clarity.

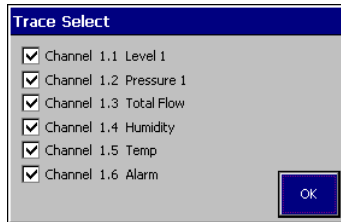

Traces are identified by the Channel Number (e.g. Ch1.1) and its tag.

Note. The recording of a channel's data is not affected by this operation and the instantaneous channel values are still shown on the indicators at the top of the screen.

Alarm Acknowledge ▶

ch1.1 Level 1
 ch1.2 Pressure 1
 ch1.3 Total Flow
 ch1.4 Humidity
 ch1.5 Temp
 ch1.6 Alarm
 All

Note. If 'Security system' is set to 'Advanced' and 'Acknowledge Security' is set to 'On'(see Section 7.6.4, page 78), alarms can be acknowledged only by Users with alarm acknowledgement privileges – see Section 7.6.5, page 80.

To acknowledge a particular alarm, use the ▲ and ▼ keys to highlight it in the menu and press the  key.

Note. Active unacknowledged alarms in the current process group are identified by a flashing Alarm Event icon to the right of the associated channel reading. Active acknowledged alarms are identified by a continuous Alarm Event icon – see item ⑥ in Fig. 4.3, page 27.

To acknowledge all active alarms in the current process group simultaneously, select 'All' and press the  key.

Note.

- If an alarm in **the other** process group is active, the Global Alarm status icon () continues to be displayed in the status bar. If an active alarm in **the other** process group is unacknowledged, the icon is surrounded by a red (color recorders) or white (monochrome recorders) flashing border.
- If 'Acknowledge Timeout' is set to 'On' (see Section 7.8.4, page 106) and the alarm condition for an acknowledged alarm is not cleared within the configured timeout period, the acknowledge state is reset to active/unacknowledged.

Alarms that have not been configured are greyed-out in the menu (color recorders) or are blanked-out when selected in the menu (monochrome recorders).

AutoView Scroll

Select to display the chart for each configured process group in turn for 20 seconds. The AutoView Scroll icon () is displayed in the status bar at the top of the screen when AutoView Scroll is active. Press any key to cancel AutoView Scroll.

If only one process group is enabled, AutoView Scroll is greyed-out in the menu (color recorders) or is blanked-out when selected in the menu (monochrome recorders).





Select to troubleshoot Math Blocks and Logic Equations.

Note.

- If the Math & Logic option has not been enabled in the software, **all** Math Blocks and Logic Equations are greyed-out in the menu (color recorders) or are blanked-out when selected in the menu (monochrome recorders).
- Unconfigured Math Blocks and Logic Equations are greyed-out in the menu (color recorders) or are blanked-out when selected in the menu (monochrome recorders).

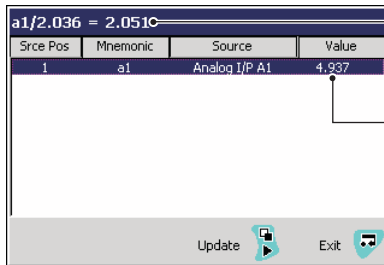
Select the Math Block or Logic Equation to diagnose and press the  key.



Math Block or Logic Equation and result when the  key was last pressed.

Value when the  key was last pressed.

Press the  key to display values and result based on most recent calculations.

Press the  key to exit.



Select to display the Instrument Status screen, providing the following information:

- Software version – version of the software currently installed.
- System version – version of the recorder's operating system
- Serial number – the serial number of the recorder.
- Instrument tag – recorder name as it appears in the recorder's archive files.
- Archive time remaining – estimated time remaining before the external archive media becomes full.
- CSV filename – if 'Archive file format' is set to 'Text format' (see page 90), the name of the archive file for process group 1 is displayed. If 'Archive file format' is set to 'Binary format', 'N/A' is displayed.
- Operating time – length of time for which the recorder has been operational.
- IP or MAC Address – internet or MAC address assigned to the recorder (display alternates between them)
- Options enabled – list of enabled software options. Blank if no options have been enabled.

Start Batch

Note. Displayed only if batch recording has been enabled during Group configuration **and** a batch is not running – see Appendix F.4.3, page 179.

Help

Select to display the Chart view on-line help.

4.4.1 Electronic Signatures

Entering an electronic signature is the equivalent to signing the chart of a conventional paper recorder. Local procedures may require the approval of a record by an authorized signatory; for this reason, an electronic signature is password protected.

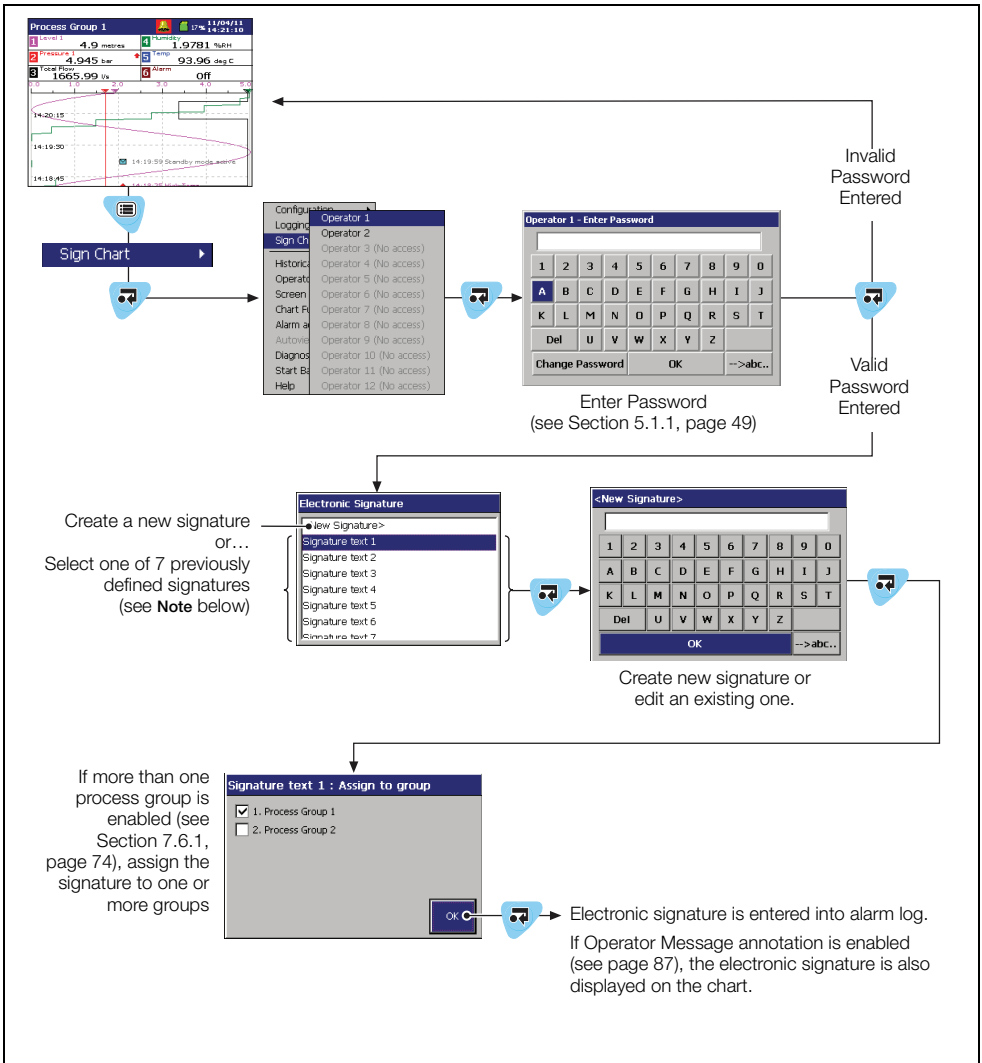

Fig. 4.4 Entering an Electronic Signature

Note. Up to 7 electronic signatures can be stored in the instrument's memory. If 7 signatures exist and a new one is created, the oldest is overwritten.

4.5 Indicator View

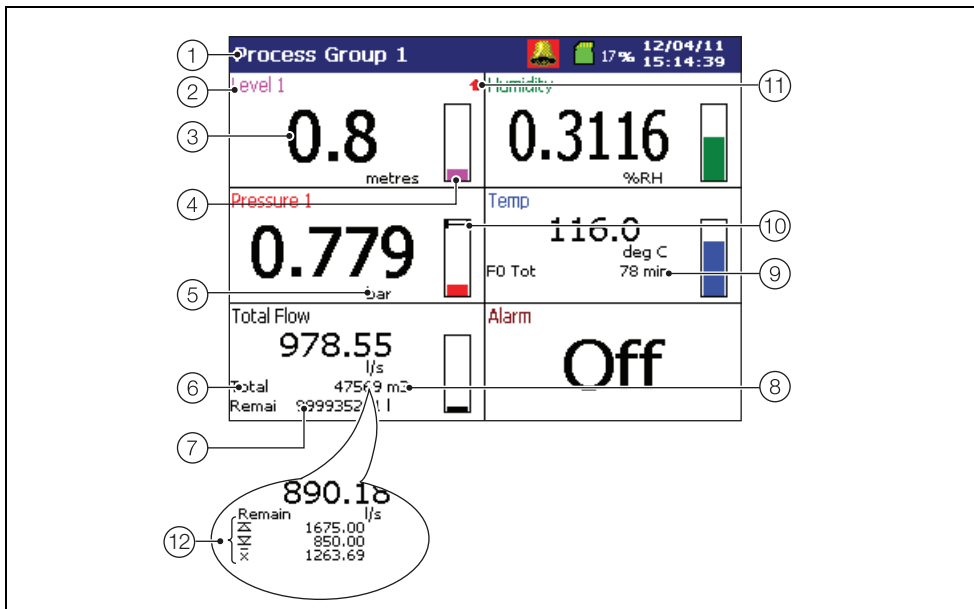

Fig. 4.5 Indicator View

Key to Fig. 4.5:

- ① Process group name.
- ② Channel tag.
- ③ Current value – see **Note 1**, page 28.
- ④ Bargraph.
- ⑤ Channel units.
- ⑥ Totalizer tag.
- ⑦ Totalizer value.
- ⑧ Totalizer units.
- ⑨ F0 value/units – see Section 7.8.6, page 112.
- ⑩ Alarm trip level (not shown for slow and fast rate alarms).
- ⑪ Alarm icon.
- ⑫ Maximum, minimum and average totalizer values (displayed only if 'Show Statistics' selected from Operator menu).

Note.

- Do not remove media while the media update in progress status icon (🔴) is displayed.
- Always set the external media Off-line before removing it – see page 51.



Configuration ▶

Select the Configuration Level – see Section 7, page 65.

Logging ▶

Select the Logging Level – see Section 5.1, page 47.

Operator Message ▶

Select to add one of 24 predefined Operator Messages (see Section 7.6.6, page 83) or one User-Defined Message to the alarm event log.

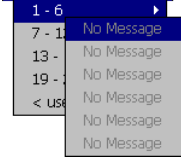

If '< user defined >' is selected, a data entry keyboard appears to enable the message to be entered (see Fig. 7.6, page 71).

The selected or user-defined message is displayed briefly on screen. If 'Operator Messages' annotation is selected in the Chart view Operator menu (see 'Chart Annotation', page 33) the message is also added to the Chart view.

Show Statistics

Note. if the Totalizer software option is not enabled, all Totalizer menu selections are greyed-out in the menu (color recorders) or are blanked-out when selected in the menu (monochrome recorders).

Show Totalizers

Select 'Show Statistics' / 'Show Totalizers' to switch between the totalizer value display and totalizer statistics display (i.e. totalizer maximum, minimum and average values).

If both totalizers on one channel are enabled and:

- 'Show Totalizers' is selected – the tag, current value and units for both totalizers are displayed together in the channel's indicator.
- 'Show Statistics' is selected – the tag, units, maximum, minimum and average values for each totalizer are displayed in turn for 5 seconds in the channel's indicator.

Totalizer Stop / Go ▶

Select to stop and start individual totalizers.

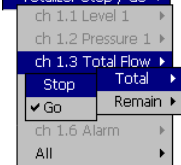

Channel totalizers that have not been enabled in the Configuration level are greyed-out in the menu (color recorders) or are blanked-out when selected in the menu (monochrome recorders).

Note. When a totalizer is not running (i.e. 'Stop' has been selected), the corresponding totalizer value is shown in red (color recorders) or white text on a black background (monochrome recorders).

Totalizer Reset ▶

Select to reset the totalizer value to the totalizer preset value.

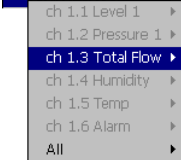

Channel totalizers that have not been enabled in the Configuration level are greyed-out in the menu (color recorders) or are blanked-out when selected in the menu (monochrome recorders).

Alarm Acknowledge ▶

ch1.1 Level 1
 ch1.2 Pressure 1
 ch1.3 Total Flow
 ch1.4 Humidity
 ch1.5 Temp
 ch1.6 Alarm
 All

Note. If 'Security system' is set to 'Advanced' and 'Acknowledge Security' is set to 'On'(see Section 7.6.4, page 78), alarms can be acknowledged only by Users with alarm acknowledgement privileges – see Section 7.6.5, page 80.

To acknowledge a particular alarm, use the ▲ and ▼ keys to highlight it in the menu and press the  key.

Note. Active unacknowledged alarms in the current process group are identified by a flashing Alarm Event icon to the right of the associated channel reading. Active acknowledged alarms are identified by a continuous Alarm Event icon – see item ⑩ in Fig. 4.5, page 38.

To acknowledge all active alarms in the current process group simultaneously, select 'All' and press the  key.

Note.

- If an alarm in **the other** process group is active, the Global Alarm status icon () continues to be displayed in the status bar. If an active alarm in **the other** process group is unacknowledged, the icon is surrounded by a red (color recorders) or white (monochrome recorders) flashing border.
- If 'Acknowledge Timeout' is set to 'On' (see Section 7.8.4, page 106) and the alarm condition for an acknowledged alarm is not cleared within the configured timeout period, the acknowledge state is reset to active/unacknowledged.

Alarms that have not been configured are greyed-out in the menu (color recorders) or are blanked-out when selected in the menu (monochrome recorders).

AutoView Scroll

Select to display the Indicator view for each configured process group in turn for 20 seconds. The AutoView Scroll status icon () is displayed in the status bar at the top of the screen when AutoView Scroll is active. Press any key to cancel AutoView Scroll.

If only one process group is enabled, AutoView Scroll is greyed-out in the menu (color recorders) or is blanked-out when selected in the menu (monochrome recorders).

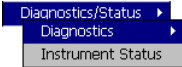

Select to troubleshoot Math Blocks and Logic Equations.

Note.

- If the Math & Logic option has not been enabled in the software, **all** Math Blocks and Logic Equations are greyed-out in the menu (color recorders) or are blanked-out when selected in the menu (monochrome recorders).
- Unconfigured Math Blocks and Logic Equations are greyed-out in the menu (color recorders) or are blanked-out when selected in the menu (monochrome recorders).

Select the Math Block or Logic Equation to diagnose and press the key.

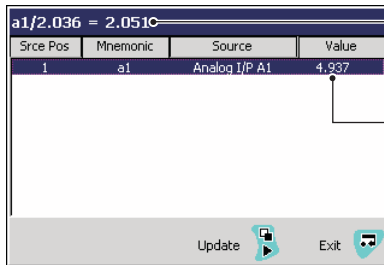

Math Block or Logic Equation and result when the key was last pressed.

Value when the key was last pressed.

Press the key to display values and result based on most recent calculations.

Press the key to exit.



Select to display the Instrument Status screen, providing the following information:

- Software version – version of the software currently installed.
- System version – version of the recorder's operating system
- Serial number – the serial number of the recorder.
- Instrument tag – recorder name as it appears in the recorder's archive files.
- Archive time remaining – estimated time remaining before the external archive media becomes full.
- CSV filename – if 'Archive file format' is set to 'Text format' (see page 90), the name of the archive file for process group 1 is displayed. If 'Archive file format' is set to 'Binary format', 'N/A' is displayed.
- Operating time – length of time for which the recorder has been operational.
- IP or MAC Address – internet or MAC address assigned to the recorder (display alternates between them)
- Options enabled – list of enabled software options. Blank if no options have been enabled.



Select to display the Indicator view on-line help.



Configuration ▶

Select the Configuration Level – see Section 7, page 65.

Logging ▶

Select the Logging Level – see Section 5.1, page 47.

Filter ▶

Group 1 Alarms
 Group 2 Alarms
 Operator Messages
 Active Transitions Only

Select the entries to be displayed in the log. ✓ Indicates entries selected.

Note.

- Hiding and displaying log entries does not affect the recording of events in the log.
- All selected alarm event transitions (from inactive to active, from active to acknowledged, from acknowledged to inactive, from active to inactive) appear in the sequence in which they occurred.
- Selecting 'Active Transitions Only' displays entries for alarms when made active and hides all acknowledged & inactive transitions.

Alarm Acknowledge ▶

ch1.1 Level 1
 ch1.2 Pressure 1
 ch1.3 Total Flow
 ch1.4 Humidity
 ch1.5 Temp
 ch1.6 Alarm
 All

Note. If 'Security system' is set to 'Advanced' and 'Acknowledge Security' is set to 'On'(see Section 7.6.4, page 78), alarms can be acknowledged only by Users with alarm acknowledgement privileges – see Section 7.6.5, page 80.

The Alarm Event log is not group specific. To acknowledge a particular alarm, use the , and keys to first select the relevant process group, followed by the alarm to be acknowledged.

To acknowledge all active alarms in the selected process group simultaneously, select 'All' and press the key.

Note. If 'Acknowledge Timeout' is set to 'On' (see Section 7.8.4, page 106) and the alarm condition for an acknowledged alarm is not cleared within the configured timeout period, the acknowledged state is reset to active/unacknowledged.

Alarms that have not been configured are greyed-out in the menu (color recorders) or are blanked-out when selected in the menu (monochrome recorders).

Help

Select to display the Alarm Event Log view on-line help.

4.8 Totalizer Log

Note.

- The Totalizer log view is displayed only if the Totalizer option has been enabled in the software.
- The Totalizer log view provides an historical log of totalizer activity. To view the current totalizer status, choose the Indicator view.
- When the number of entries in the Totalizer log has reached 200, the oldest data is overwritten by the newest. Entries are renumbered so that the number of the oldest entry is always 00.
- The logging of totalizer values can be triggered at pre-determined intervals and/or by digital signal – see 'Log update', page 109.

No	Tag/Value	Source Tag	Date	Time
15	Remain	Tank 1	31/07/06	14:08:11
	10000000000 Litres			
	0.4 Litres		31/07/06	14:08:10
	0.4 Litres		31/07/06	14:08:10
	0.4 Litres			
16	Tot Fl	Tank 1	31/07/06	14:17:47
	4006 m ³			
	100.0 Litres		31/07/06	14:08:10
	0.4 Litres		31/07/06	14:08:10
	54.5 Litres			
17	F0 Tot	Temp	31/07/06	14:21:10
	14			

Fig. 4.8 Totalizer Log

Key to Fig. 4.8:

- ① Log entry number.
- ② Totalizer icon.
- ③ Batch total at the time of the event.
- ④ Maximum, minimum and average of the value being totalized at the time of the event.
- ⑤ F₀ totalizer entry – see Section 7.8.6, page 112.
- ⑥ Oldest data – press the key to view the previous page of data.
- ⑦ Date/time at which the maximum and minimum flowrates occurred.
- ⑧ Newest data – press the key to view the next page of data.

Note. Maximum, minimum and average statistics are not shown unless enabled in the 'Filter' menu – see page 46.



Configuration ▶

Select the Configuration Level – see Section 7, page 65.

Logging ▶

Select the Logging Level – see Section 5.1, page 47.

Filter ▶

✓ Group 1 Totalizers

Group 2 Totalizers

✓ Statistics

Select the entries to be displayed in the log.

- Group 1 Totalizers—displays data for all enabled Process Group 1 totalizers.
- Group 2 Totalizers—displays data for all enabled Process Group 2 totalizers
- Statistics—displays the maximum, minimum and average values of the analog value being totalized, together with the dates and times at which all maximum and minimum values occurred.

These values are reset when the totalizer is reset and are updated only when the totalizer is running.

✓ indicates the entries selected.

Note. Hiding and displaying log entries does not affect the recording of totalizer data in the log.

Help

Select to display the Totalizer Log view on-line help.

5 Logging

If logging security is enabled (see Section 5.1), an Operator whose access privileges include Logging access is able to:

- Start/Stop recording
- Switch between primary and secondary recording rates
- Adjust an input
- Reset archiving
- Set the archive media card 'On-line' and 'Off-line'
- View internal and external archive media file directories and delete files from external archive media

5.1 Logging Access

Access to Logging is controlled by the recorder's Security System.

- If 'Security System' is set to 'Basic' and 'Logging Security' is set to 'Off', access to the Logging facility is unrestricted.
- If 'Security System' is set to 'Basic' and 'Logging Security' is set to 'On', access to the Logging facility is protected by a single password for all users. Refer to Fig. 5.1 to access Logging.
- If 'Security System' is set to 'Advanced' and 'Logging Security' is set to 'On', access to the Logging facility is protected by a unique password for each authorized user. Refer to Fig. 5.2, page 48 to access Logging.

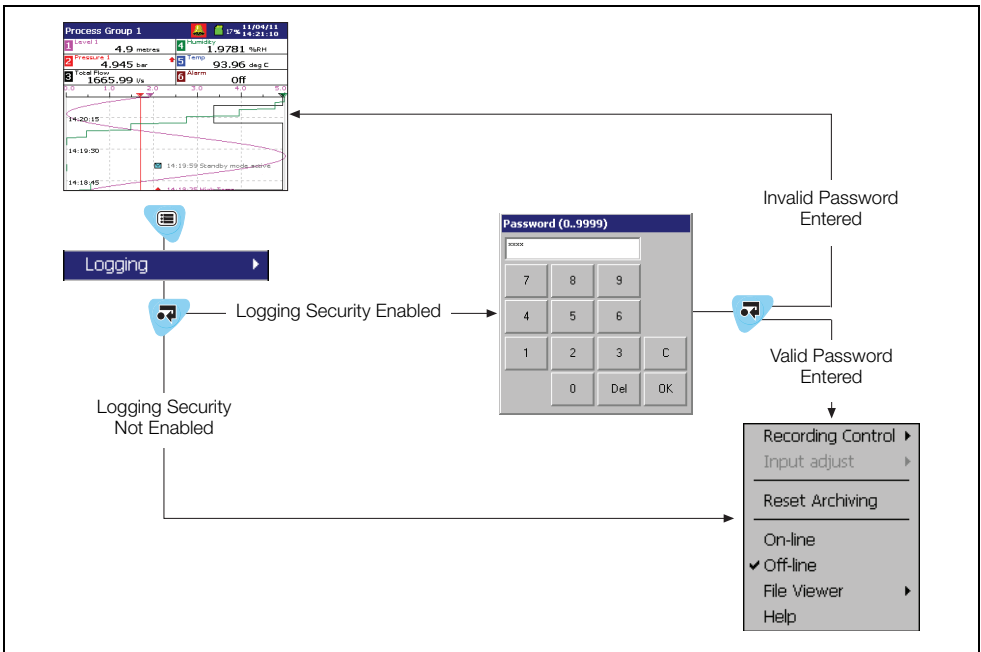

Fig. 5.1 Accessing Logging – Basic Security

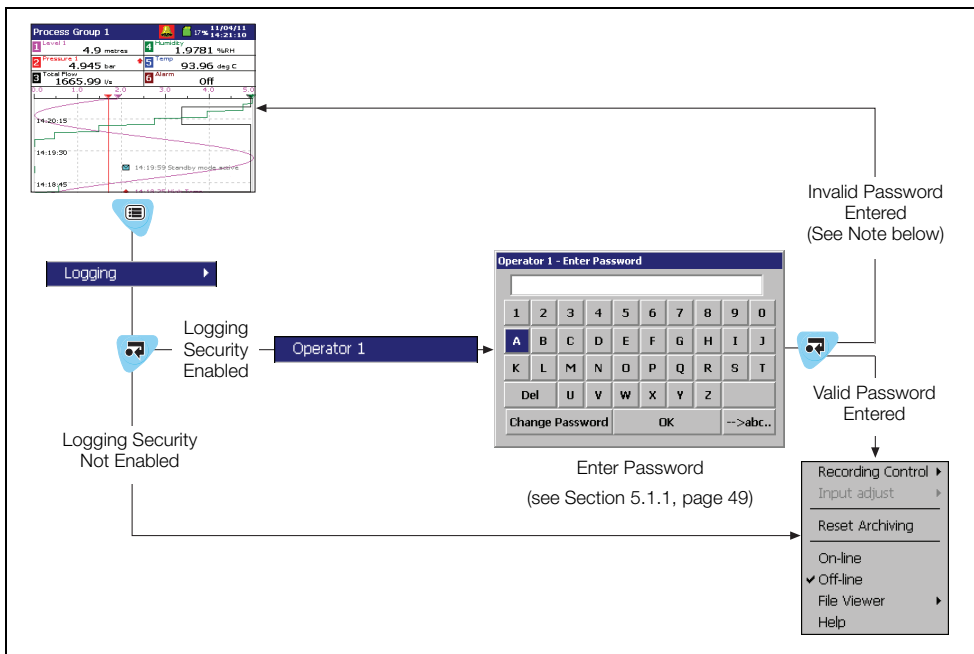

Fig. 5.2 Accessing Logging – Advanced Security

Note. If an incorrect password is entered the display returns to the Operating view. However, if the maximum number of consecutive incorrect password entries is exceeded, the user's access privileges are removed and the following message is displayed:



If this occurs, access privileges can be reinstated only by the system administrator (User 1). If the system administrator's access privileges have been removed, the security system must be disabled using the configuration security switch to gain access to the configuration.

5.1.1 Password Entry



Enter password

1. Select the required character using the , , and keys.
2. Add the selected character to the password string using the key.

Note. For security, all characters are displayed as '*'

3. Repeat 1 and 2 until all characters have been entered.
1. Highlight the 'OK' button using the , , and keys and press .

Change password



1. Select 'Change Password' using the , , and keys and press .

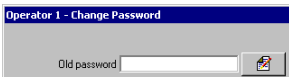

1. Highlight the Edit Button () using the and keys and press to display the character entry box.



1. Enter the old password using the , , and keys. Highlight the 'OK' button and press .



2. Enter the new password using the same procedure as for the old password.

3. Enter the new password again to confirm it.

4. Highlight the 'OK' button and press .

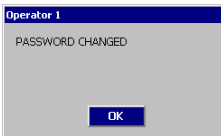

Password change successful.

Note. If the key is pressed at any stage or 'OK' is selected before the new password is confirmed, the password change operation is cancelled and the following message is displayed:

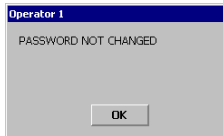

Password expired

Passwords can be configured to expire at pre-determined intervals. If a password is time expired, this screen is displayed automatically. Enter a new password as described above.



5.2 Logging Menu

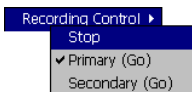

Use this menu to stop and start recording or switch between the Primary and Secondary sample rates for the current Process Group.

The Primary sample rate is set typically to a relatively slow rate (depending upon process recording requirements) and is active during normal process operating conditions in order to maximize internal memory and external archive media.

The Secondary sample rate is set typically to a faster rate than the Primary sample rate and may be selected manually in order to record the maximum amount of detail during, for example, an alarm condition.

The rates are set during configuration – see page 85.

Note.

- Switching between the primary and secondary sample rates does not affect the screen interval in the Vertical and Horizontal Chart views.
- When the channels are set to 'Stop' the instantaneous values in the associated indicators are displayed in red (color recorders) or white on a black background (monochrome recorders) and, after the end of the next sample period, no further samples are plotted on the associated traces.
- Digital recording channels can only be set to 'Stop' or 'Go'.
- Recording control can also be implemented using digital sources – see Sections 7.7.1 page 84 and 7.8.1 page 93.



Note. Available only if 'Operator Calibrate' on the I/O Modules configuration tab is set to 'On' – see Section 7.10.1, page 117.

Manually fine-tune inputs to remove process offset errors or system scale errors.



If selected, the date of the oldest unarchived data is set to that of the oldest data in the internal flash memory. This allows all data in the internal memory to be re-archived to external media.

Note. Insert a blank media storage card prior to selecting this function.

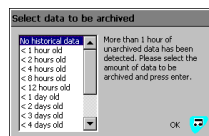

To re-archive data:

1. Insert archive media, with sufficient free space, into the recorder.
2. Select 'Off-line' in the Logging menu.
3. Select 'Reset archiving' in the logging menu.
4. Select 'On-line' in the Logging menu.
5. Select data to be archived if >1 hour (Text format) or >1 day (Binary format) of data in internal memory and press .

On-line

Places the archive media on-line, starting the archiving process.

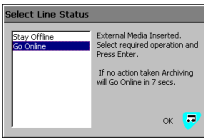

Note.

- The On-line function is disabled (greyed-out in the menu (color recorders) or blanked-out when selected in the menu (monochrome recorders)) if no archive media card is inserted or the recorder has been placed in Historical Review mode.
- When an archive media card is inserted and there is <1 hour (Text format) or <1 day (Binary format), the 'Select Line Status' dialog box (left) is displayed, giving the user the choice of placing archiving on-line or remaining off-line. Archiving is placed automatically on-line in 10 seconds unless 'Stay Offline' is selected.
- When an archive media card is inserted and there is >1 hour (Text format) or >1 day (Binary format) of data in internal memory, the 'Select data to be archived' dialog box (previous page) is displayed. Select data to be archived and press

Once selected, all data within the selected time frame is archived. Older unarchived data remains in the internal memory buffer until overwritten by newer data but is not available for archiving unless 'Reset archiving' is selected.

Off-line

Places the archive media off-line. Recording of channel data into internal memory continues uninterrupted but archiving to the removable media is suspended until it is put on-line again.

Note.

- Always set the external media Off-line before removing it.
- The Off-line function is disabled (greyed-out in the menu (color recorders) or blanked-out when selected in the menu (monochrome recorders)) when in Historical Review mode.
- Archive media can also be set off-line by opening the recorder's door and pressing the recessed button to the right of the red Archiving On-line LED indicator next to the SD card slot on the back of the door.

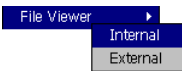

Use the file viewer to view a list of the files stored in internal memory and on external archive media.

Note. Files stored in internal memory cannot be deleted.

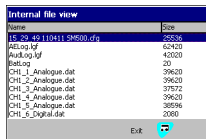

Help















Select to display the Logging on-line help.

6 Archiving

6.1 Introduction

Recorded data, logs and configuration files stored in the recorder's internal memory can be archived to files created on removable Secure Digital (SD) card media in either text or binary encoded format. Parameters for archiving Process Groups 1 and 2 data are configured independently.

The following icons are displayed in the Status bar to indicate the status of Logging and the external SD card media:

Display Type		
Color	Monochrome	
		- External archive media on-line with % used indication
		- External archive media off-line with % used indication
		- External archive media not inserted (flashing exclamation mark)
		- Media update in progress. <i>Do not remove media while this symbol is displayed</i>
		- External media 100% full, archiving stopped (flashing cross)
		- Warning! Too many files (left-hand icon – media online, right-hand icon – media offline)
		- Too many files, archiving stopped (flashing cross)

The Instrument Status screen displays the approximate time left before the current external archive media is full, assuming the amount of data recorded remains the same.

Note. To avoid loss of archive data, **always** place the media card off-line **before** removing it. The media card can be placed off-line in one of two ways:

- Select 'Off-line' from the Logging menu.
- Open the recorder's door and press the recessed button to the right of the Archiving On-line LED indicator next to the SD card slot on the back of the door.

Caution. Electrostatic precautions for SD cards.

To avoid potential damage or corruption to data recorded on an SD card, take care when handling and storing the card. Do not expose the card to static electricity, electrical noise or magnetic fields. When handling the card take care not to touch any exposed metal contacts.

6.2 Sample Rates

Data is saved to the archive file at the same rate as it is saved to internal memory, i.e. at either the Group's primary or secondary recording sample rate.

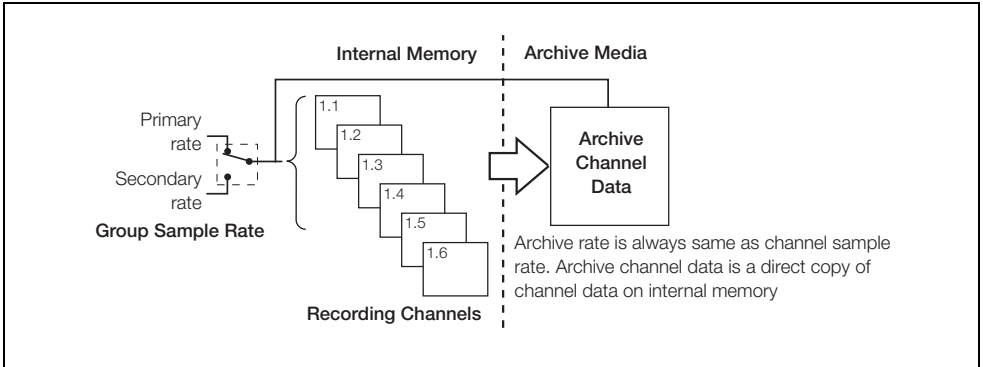

Fig. 6.1 Archiving Sample Rates

6.3 Archive File Types

Archive files are created in one of two user-selectable formats:

Text (comma separated values [.csv]) – see Section 6.4, page 54

or

Secure binary encoded – see Section 6.5, page 59

All archive files created by the recorder are given filenames automatically but each type of archived file is given a different file extension depending on whether Text or Binary format has been selected during archive configuration – see Section 7.7.4, page 90. File types and extensions for Text files are shown in Table 6.1. File types and extensions for Binary files are shown in Table 6.2.

Type	Extension	Contents
Channel data files	*.D**	Analog or digital recording channels in the current process group.
Alarm event log files	*.E**	The historical record of the alarm events related to the group's channels plus the history of any operator messages.
Totalizer log files	*.T**	The historical record of all totalizer and associated statistical values relating to the group's recording channels.
Audit log files	*.A**	The historical entries from the audit log. (Note. The content of this file is the same for all groups).
Digital signature files	*.S**	Digital signature file for the corresponding channel data file.

Table 6.1 Text Format File Types and Extensions

Type	Extension	No. of Files	Contents
Channel data files	*.B00	One per channel	Analog or digital recording channel data.
Batch channel data files	*.V**	One per channel	Batch recording channel data *.
Alarm event log files	*.EE0	One per process group	The historical record of the alarm events related to a particular process group's channels plus the history of any operator messages.
Totalizer log files	*.TE0	One per process group	The historical record of all totalizer and associated statistical values relating to a particular group's recording channels.
Audit log files	*.AE0	One per recorder	The historical entries from the audit log.
Batch log files	*.X**	One per process group	Batch information associated with a process group *.

Table 6.2 Binary Encoded Format File Types and Extensions

Note. Totalizer files are created only if the totalizer option is enabled.

6.4 Text Format Archive Files

6.4.1 Text Format Channel Data Files

Text format channel data files can be configured to contain data gathered over a predefined period of time using the 'New File Interval' setting – see Table 6.3.

New File Interval	Filename
Hourly	<hour> <day, month, year>* <filename tag>
Daily	<day, month, year>* <filename tag>
Monthly	<month, year>* <filename tag>
None	<filename tag>

*Formatted according to the date format set in Common Configuration – see Section 7.6.3, page 76

Table 6.3 New Text File Intervals

Note. The 'New File Interval' is set in the Configuration level – see Section 7.7.4, page 90.

In addition to new channel data files being created according to the New File Interval selection, they are also created in the following circumstances:

- The recorder's power is lost then restored.
- The recorder is taken offline and the archive media removed, replaced or refitted.
- The recorder's configuration is changed.
- One of the current files exceeds the maximum permissible size.
- When the daylight saving period starts or ends.

Note. The recorder's internal clock can be configured to adjust automatically at the start and end of Daylight Saving Time (Summertime) periods – see Section 7.6.3, page 76.

When one of the above conditions occurs, new channel data files are created for each enabled group and the file extension index on each new file is incremented by one from the previous file.

Example – if the original file had an extension of .D00, after one of the above events a new file will be created with the same filename but an extension of .D01.

Files containing data generated during the daylight saving period (summertime) have '~DS' appended to the filename.

Example 1 – Start of daylight saving period:

A daily file is started at 00:00:00 on 30th March 2003 –filename: 30Mar03ProcessGroup1.D00.

Summertime starts at 2:00am on 30th March 2003.

The clock changes automatically to 3:00am.

The existing file is closed and a new file is created –filename: 30Mar03ProcessGroup1~DS.D00.

The file '30Mar03ProcessGroup1.D00' contains data generated from 00:00:00 to 01:59:59 (before summertime starts).

The file '30Mar03ProcessGroup1~DS.D00' contains data generated from 03:00:00 (after summertime starts).

Example 2 – End of daylight saving period:

A daily file is started at 00:00:00 on 26th October 2003 –filename: 26Oct03ProcessGroup1~DS.D00

Summertime ends at 3:00am on 26th October 2003.

The clock changes automatically to 2:00am.

The existing file is closed and a new file is created –filename: 26Oct03ProcessGroup1.D00

The file '26Oct03ProcessGroup1~DS.D00' contains data generated from 00:00:00 to 02:59:59 (before summertime ends).

The file '26Oct03ProcessGroup1.D00' contains data generated from 02:00:00 (after summertime ends)

6.4.2 Text Format Filename Examples

'New file interval' set to 'Hourly', 'Filename tag' set to 'Process Group 1' (see Section 7.7.4, page 90); date is 10th October 2000; Channel data and alarm event log files only enabled:

9:00 am – New file created in which all channel data recorded between 9:00 and 9:59:59 is archived in the following file:

09_00_10Oct00_Process_Group_1.d00

09:12am – Power interrupt occurs

09:13am – Power restored and new file created:

09_00_10Oct00_Process_Group_1.d01

10:00am – New file created in which all data recorded between 10:00 and 10:59:59 is archived.

10_00_10Oct00_Process_Group_1.d00

Note.

- Hourly files start exactly on the hour.
- Daily files start at 00:00:00.
- Monthly files start at 00:00:00 on the first of the month.

6.4.3 Text Format Log files

The Alarm Event and Totalizer Logs for each Process Group and the Audit Log are archived into individual files. The filenames are formatted as shown in Table 6.4 with the date and the time indicating the first entry in the file.

Log File	Filename
Alarm Event	<hour min> <dd, mm, yy>* <process group tag>.e00
Totalizer	<hour min> <dd, mm, yy>* <process group tag>.t00
Audit	<hour min> <dd, mm, yy>* <instrument tag>.a00

*Formatted according to the date format set in Common Configuration – see Section 7.6.3, page 76

Table 6.4 Log File Formats

If one of the archive log files becomes full (>65000 entries) a new file is created with an extension incremented by 1, e.g. a01, e01 etc.

Note. Totalizer logs are created only if the totalizer option is enabled.

New text format log data files are also created when the daylight saving period starts or ends.

Files containing log data generated during the daylight saving period (summertime) have '~DS' appended to the filename.

6.4.4 Text Format Data File Examples

Text format archived data is stored in a comma separated value (*.csv) format so that it can be imported directly into a standard spreadsheet, e.g. Microsoft Excel™ and Lotus 1-2-3™. The files can also be read as an ASCII text file by a text viewer. When imported into a spreadsheet, the files appear as shown in Figs. 6.2 to 6.5.

Alternatively, detailed graphical analysis of the data can be carried out on a PC using the Company's DataManager data analysis software package.

	A	B	C	D	E	F	G	H	I	J	K
1											
2	Configuration file		10_30_25 12 Apr 00	Instrument #3							
3	Group tag		Plant A - Zone 1								
4											
5	CH1.1	Boiler 1 temperature	No. dp's =	0	Eng lo =	-50	Eng hi =	1300	°C		
6	CH1.2	Inlet flow rate	No. dp's =	1	Eng lo =	0	Eng hi =	999.9	Ltr/h		
7	CH1.3	OFF									
8	CH1.4	Ambient min temp	No. dp's =	2	Eng lo =	10	Eng hi =	120	°F		
9	CH1.5	Tank 1 level	No. dp's =	1	Eng lo =	0	Eng hi =	200	Litres		
10	CH1.6	Digital			0 =	Close	1 =	Open			
11											
12	Date	Time	Boiler 1	Flow 1	Amb max	Amb min	Tank 1	Tank 1	Inlet		
13			CH1.1	CH1.2	CH1.3	CH1.4	CH1.5	CH1.5	CH1.6		
14			°C	Ltr/h		°F	Litres	Litres	0=Close		
15			instant	ave	OFF	min	max	min	1 = Open		
16	12-Apr-00	11:00:00.0	500	800.1		58.9	75.8	75.8	0		
17	12-Apr-00	11:00:00.1	501	800.2		58.71	76.3	76	0		
18	12-Apr-00	11:00:00.2	502	800.3		58.81	76.8	76.5	0		
19	12-Apr-00	11:00:00.3	503	800.4		58.91	77.3	77	0		
20	12-Apr-00	11:00:00.4	505	800.5		59.01	77.8	77.5	0		
21	12-Apr-00	11:00:00.5	504	800.6		59.11	78.3	78	0		

Fig. 6.2 Channel Data File Sample – Text Format

	A	B	C	D	E	F	G	H
1	Group tag		Plant A - Zone 1					
2								
3	Date	Time	Type	Event tag	Source tag	Trip value	Units	State
4	12-Apr-00	08:00:00	Hi Process	Boiler 1 too high	Boiler 1	750	C	Active
5	12-Apr-00	08:10:00	Lo Process	Flow 2 below limit	Flow 2	5.2	Ltr/h	Active
6	12-Apr-00	08:20:00	Hi Process	Boiler 1 too high	Boiler 1	750	C	Active
7	12-Apr-00	08:30:00	Lo Process	Flow 2 below limit	Flow 2	5.2	Ltr/h	Active
8	12-Apr-00	08:40:00	Hi Process	Boiler 1 too high	Boiler 1	750	C	Inactive
9	12-Apr-00	08:50:00	Lo Process	Flow 2 below limit	Flow 2	5.2	Ltr/h	Inactive
10	12-Apr-00	09:00:00	Op Message	Batch 1 started				
11	12-Apr-00	09:10:00	Hi Process	Reduce flow	Zone 3	275.3	m	Active
12	12-Apr-00	09:20:00	Lo Process	Open Inlet Valve	Flow 5	500	Gal/h	Active
13	12-Apr-00	09:30:00	Lo Process	Open Inlet Valve	Flow 5	500	Gal/h	Active

Fig. 6.3 Alarm Event Log Sample – Text Format

	B	C	D	E	F	G	H	I	J	K
1		Plant A - Zone 1								
2										
3	Boiler 1 temperature		No. dp's = 0		Eng lo = -50		Eng hi = 1300	C		
4	Inlet flow rate		No. dp's = 1		Eng lo = 0		Eng hi = 999.9	Ltr/h		
5	Ambient max temp		No. dp's = 2		Eng lo = 10		Eng hi = 120	F		
6	Ambient min temp		No. dp's = 2		Eng lo = 10		Eng hi = 120	F		
7	Tank 1 level		No. dp's = 1		Eng lo = 0		Eng hi = 200	Litres		
8	Digital				0 = Close		1 = Open			
9										
10										
11	Time	Totalizer Tag	Source tag	Batch total	Total units	Max value	Min value	Average	Units	Secure Total
12										
13	08:00:00	FT_Zone 1_123.1	Flow 1	1232134578	Litres	800.1	800.1	800.1	Ltr/h	8932103235
14	08:10:00	FT_Zone 1_123.1	Flow 1	1232134628	Litres	810.4	805.2	807.8	Ltr/h	8932103285
15	08:20:00	FT_Zone 1_123.1	Flow 1	1232134678	Litres	820.7	815.5	818.1	Ltr/h	8932103335
16	08:30:00	FT_Zone 1_123.1	Flow 1	1232134728	Litres	831	825.8	828.4	Ltr/h	8932103385
17	08:40:00	FT_Zone 1_123.1	Flow 1	1232134778	Litres	841.3	836.1	838.7	Ltr/h	8932103435
18	08:50:00	FT_Zone 1_123.1	Flow 1	1232134828	Litres	851.6	846.4	849	Ltr/h	8932103485
19	09:00:00	FT_Zone 1_123.1	Flow 1	1232134878	Litres	861.9	856.7	859.3	Ltr/h	8932103535
20	09:10:00	FT_Zone 1_123.1	Flow 1	1232134928	Litres	872.2	867	869.6	Ltr/h	8932103585

Fig. 6.4 Totalizer Log Sample – Text Format

	A	B	C	D	E
1	Date	Time	Type of event	Description	Op id
2					
3	12-Apr-00	08:00:00	Power failure		User 4
4	12-Apr-00	08:10:00	Power recovery		User 4
5	12-Apr-00	08:30:00	Analog i/p Calibration	Module A	User 1
6	12-Apr-00	08:40:00	Analog i/p Calibration	Module B	User 1
7	12-Apr-00	08:50:00	File Created	Configuration	User 1
8	12-Apr-00	09:00:00	File Created	Group 1 data	User 1
9	12-Apr-00	09:10:00	File Created	Group 1 alarm event log	User 1
10	12-Apr-00	09:40:00	Configuration change		User 3
11	12-Apr-00	09:50:00	Media removed		User 3

Fig. 6.5 Audit Log Sample – Text Format

6.4.5 Text Format Data File Digital Signatures

A digital signature file is created for each channel data file using the same filename but with a *.S** extension. The file contains a unique 'fingerprint' of the contents of the data file that can be used to prove if the data has been tampered with or corrupted. Data validation can be carried out on a PC using the Company's DataManager software package.

6.4.6 Text Format Data Verification and Integrity

When data is saved to the archive media it is checked automatically to verify that the date value stored on the media matches exactly the date value stored in the internal memory.

6.5 Binary Format Archive Files

6.5.1 Binary Format Archive Filenames

Examples of binary archive filenames are shown in Table 6.5.

Type	Format
Channel data files	<Start Time HHMMSS><Start Date DDMMYY>Ch<Group>_<Channel><Instrument tag> e.g. 14322719Dec03Ch1_2Boiler room3
Alarm event log files	<Start Time HH_MM><Start Date DDMMYY><Process Group Tag> e.g. 14_3219Dec03Boiler5
Totalizer log files	<Start Time HH_MM><Start Date DDMMYY><Process Group Tag> e.g. 14_3219Dec03Boiler5
Audit log files	<Start Time HH_MM><Start Date DDMMYY><Instrument Tag> e.g. 14_3219Dec03Boiler room 3
Batch log files	<Start Time HH_MM><Start Date DDMMYY><Instrument Tag> e.g. 14_3219Dec03Boiler room 3

Table 6.5 Binary Archive Filenames

6.5.2 Binary Format Channel Data Files

A new binary format channel data file is created under the following conditions:

- When the current file for a channel does not exist on the media card.
- When the maximum size (5Mb) of the existing data file is exceeded.
- When the recording channel's configuration is changed.
- When the daylight saving period starts or ends.

Note. The recorder's internal clock can be configured to adjust automatically at the start and end of Daylight Saving Time (Summertime) periods – see Section 7.6.3, page 76.

Files containing channel data generated during the daylight saving period (summertime) have '~DS' appended to the filename.

Example 1 – Start of daylight saving period:

Archiving is started at 01:45:00 on 30th March 2003 – filename:

01450030Mar03Ch1_1AnlgSM2000.B00.

Summertime starts at 2:00am on 30th March 2003.

The clock changes automatically to 3:00am.

The existing file is closed and a new file is created – filename:

03000030Mar03Ch1_1AnlgSM2000~DS.B00.

The file '01450330Mar03Ch1_1AnlgSM2000.B00' contains data generated from 01:45:00 to 01:59:59 (before summertime starts).

The file '03000030Mar03Ch1_1AnlgSM2000~DS.B00' contains data generated from 03:00:00 (after summertime starts).

Example 2 – End of daylight saving period:

Archiving is started at 00:15:00 on 26th October 2003 – filename:

00150026Oct03Ch1_1AnlgSM2000~DS.B00.

Summertime ends at 3:00am on 26th October 2003.

The clock changes automatically to 2:00am.

The existing file is closed and a new file is created – filename:

02000026Oct03Ch1_1AnlgSM2000.B00.

The file '00150026Oct03Ch1_1AnlgSM2000~DS.D00' contains data generated from 00:15:00 to 02:59:59 (before summertime ends).

The file '02000026Oct03Ch1_1AnlgSM2000' contains data generated from 02:00:00 (after summertime ends).

6.5.3 Binary Format Log files

A new binary log file is created under the following conditions:

- When an existing valid binary log file does not exist on the media card.
- When the maximum size (65000 entries) is exceeded.
- When the daylight saving period starts or ends.

Files containing log data generated during the daylight saving period (summertime) have "~DS" appended to the filename.

6.5.4 Binary Format Data File Examples

Binary format archived data is stored in a secure binary encoded format. A separate file is created for each recording channel. The log data is stored in an encrypted text format. The files can be read on a PC using the Company's DataManager data analysis software package.

Note. Binary format archive files created during the daylight saving period (summertime) are compatible with the database feature of Version 6.2 (or later) only of the Company's DataManager data analysis software package.

Instrument:	SM2000(A/45678/4/4)						
Group tag	Boiler Room 1						
CH1.1	Boiler Pressure	0.0..100.0	bar				
CH1.2	Inlet Flow Rate	0.0..100.0	Gal/h				
CH1.3	Tank Level	0.0..5000	Gal				
CH1.4	Outlet Flow Rate	0.0..100.0	Gal/h				
CH1.5	Boiler Temperature	0.0..1000	C				
CH1.6	Valve Status	Close..Open					
SM2000(A/45678/4/4) Process Group 2 Data Integrity Verified Successfully							
Date	Time	Press	InFlow	Level	OutFlow	Temp	Valve
		CH1.1	CH1.2	CH1.3	CH1.4	CH1.5	CH1.6
		bar	Gal/h	Gal	Gal/h	C	0= Close
		instant	instant	instant	instant	instant	1= Open
28/May/03	00:54:15	64.2	80.1	51.5	33.1	69.3	0
28/May/03	00:54:16	64.3	80.2	51.6	33.2	69.9	0
28/May/03	00:54:17	64.4	80.2	51.7	33.3	70.4	0
28/May/03	00:54:18	64.5	80.3	51.8	33.4	71.0	0
28/May/03	00:54:19	64.6	80.3	51.9	33.5	71.6	0
28/May/03	00:54:20	64.7	80.4	52.0	33.6	72.1	0
28/May/03	00:54:21	64.8	80.4	52.1	33.7	72.7	0
28/May/03	00:54:22	64.8	80.5	52.2	33.8	73.2	0

Fig. 6.6 Channel Data File Sample – Binary Format

SM2000(A/45678/4/4) Process Group 1								
Date	Time	Type	Event tag	Source tag	Trip Value	Units	State	Ack
27/May/03	14:25:50	High process	Pressure 1 too high	Boiler 1	80	Bar	Active	Yes
27/May/03	14:26:50	Low process	Flow 1 below limit	Flow 1	5.2	Gal/h	Inactive	No
27/May/03	14:28:22	High process	Flow 2 above limit	Flow 2	12.2	Gal/h	Inactive	No
27/May/03	14:30:22	High process	Flow 2 above limit	Flow 2	12.2	%	Active	No
27/May/03	14:45:00	Real Time Alarm	Start Boiler 2				Active	No
27/May/03	14:48:52	High Rate	In Flow 1 too high	In Flow 1	5	Gal/h	Active	No
27/May/03	14:51:26	Op Message	Batch 1 Started					
27/May/03	14:51:26	High process	1.1A	I/P A1	50	%	Active	No
27/May/03	15:11:55	High process	1.1A	I/P A1	50	%	Inactive	No
27/May/03	14:45:00	Real Time Alarm	Start Boiler 1				Active	No

Fig. 6.7 Alarm Event Log Sample – Binary Format

SM2000(A/45678/4/4) Process Group 1												
Date	Time	Totalizer Tag	Source tag	Batch Total	Total units	Max value	Min value	Average	Units	Secure Total	Events	
27/May/03	14:30:00	Total Flow 1.1	Flow 1	320000	Gal	99.9	39.9	72.3	Gal/h	320800	Started	
27/May/03	14:30:00	Total Tank 1.1	Tank 1	320000	Gal	99.9	39.9	72.4	Gal/h	321538	Started	
27/May/03	15:00:00	Total Flow 1.1	Flow 1	322112	Gal	99.9	39.9	72.3	Gal/h	322112	Timed	
27/May/03	15:15:00	Total Tank 1.1	Tank 1	322758	Gal	99.9	39.9	72.3	Gal/h	322758	Timed	
27/May/03	15:30:00	Total Flow 1.1	Flow 1	323484	Gal	99.9	39.9	72.4	Gal/h	323484	Timed	
27/May/03	15:45:00	Total Tank 1.1	Tank 1	324046	Gal	99.9	39.9	72.3	Gal/h	324046	Timed	
27/May/03	16:00:00	Total Flow 1.1	Flow 1	324720	Gal	99.9	39.9	72.4	Gal/h	324720	Timed	
27/May/03	16:15:00	Total Tank 1.1	Tank 1	325426	Gal	99.9	39.9	72.4	Gal/h	325426	Timed	
27/May/03	16:30:00	Total Flow 1.1	Flow 1	325963	Gal	99.9	39.9	72.3	Gal/h	325963	Timed	
27/May/03	16:45:00	Total Tank 1.1	Tank 1	326666	Gal	99.9	39.9	72.4	Gal/h	326666	Timed	
27/May/03	17:00:00	Total Flow 1.1	Flow 1	327366	Gal	99.9	39.9	72.4	Gal/h	327366	Timed	
27/May/03	17:15:00	Total Tank 1.1	Tank 1	327926	Gal	99.9	39.9	72.3	Gal/h	327926	Timed	
27/May/03	17:30:00	Total Flow 1.1	Flow 1	328649	Gal	99.9	39.9	72.4	Gal/h	328649	Reset	
27/May/03	17:30:00	Total Tank 1.1	Tank 1	328302	Gal	99.9	39.9	72.4	Gal/h	329302	Reset	

Fig. 6.8 Totalizer Log Sample – Binary Format

SM2000(A/45678/4/4)				
Date	Time	Type of event	Description	Op id
27/May/03	14:34:43	Power Failure		
27/May/03	14:50:09	Power Recovery		
27/May/03	14:54:39	Analog I/p Calibration	Module A	Joe Smith
27/May/03	14:57:11	Configuration change		Joe Smith
27/May/03	14:59:19	Online	Archiving data in group:1,2	
27/May/03	15:45:59	Offline		
27/May/03	15:46:02	Media removed		
28/May/03	08:16:43	Media inserted		
28/May/03	08:16:45	Online	Archiving data in group:1,2	

Fig. 6.9 Audit Log Sample – Binary Format

6.5.5 Binary Format Data Verification and Integrity

When data is saved to the archive media it is checked automatically to verify that the data stored on the media matches exactly what is stored in the internal memory.

Each block of data in the channel data files has its own data integrity check. This enables the integrity of the data stored on the external media card to be verified when it is viewed using the Company's DataManager software package.

The log files also contain built-in integrity checks enabling the integrity of the data to be verified by the DataManager software.

6.6 Archiving Online/Offline

Before data can be archived to external media, the external media must be placed on-line and one or more archive file enables set.

- When an external archive media card is inserted and there is <1 day (Binary format) or <1 hour (Text format) of data in internal memory, a dialog box is displayed giving the user the choice of putting the media on-line or remaining off-line. If no selection is made within 10 seconds, the media card is placed on-line automatically:

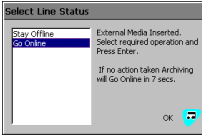

- When an external archive media card is inserted and there is >1 day (Binary format) or >1 hour (Text format) of data in internal memory, a dialog box is displayed prompting the user to select either the data to be archived or remain off-line:

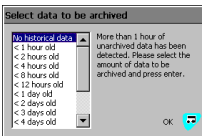

- If a large amount of Text format unarchived data is selected, a progress bar appears. During this time operator views cannot be accessed, but new data continues to be recorded to the internal buffer memory.

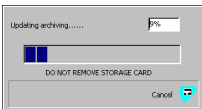

- External archive media can be set on-line (if a media card is inserted) or off-line in the setup menu.
- Set archiving off-line before removing external media to prevent loss of data and possible damage to the media card.
- When external archive media contains approximately 250 files, its read/write performance begins to degrade and either of the 'Warning – Too Many Files' icons (⚠ or ⚠ [color recorders] or ⚠ or ⚠ [monochrome recorders]) are displayed. Change the media as soon as possible.
- When external archive media contains approximately 300 files, its read/write performance becomes too slow, Archiving is stopped automatically and the 'Too Many Files – Archiving Stopped' icons (⚠ alternating with ⚠ [color recorders] or ⚠ alternating with ⚠ [monochrome recorders]) are displayed. Change the media immediately to prevent loss of data.

Note. Data stored in the internal memory buffer can still be transferred to the archive media when the archive media is placed on-line again (providing it is not off-line so long that the un-archived data in the internal memory is overwritten).

6.7 Backing-up Archived Data

It is advisable to back-up critical data stored on archive media on a regular basis. The recorder's internal memory provides a buffer for the most recent data so, if data stored on archive media is lost, it can be re-archived – see 'Reset archiving', page 50.

To ensure that all required data is available for re-archiving, it is recommended that data archived on archive media is removed and backed-up before the recorder's internal buffer overwrites that data. The length of time that data remains in the recorder's internal memory depends on the sample rate and the number of channels selected – see Table C.1, page 162 for details.

6.8 Archive Wrap

Archiving can be configured to delete the oldest archived data file automatically from the external media when the media approaches its maximum capacity – see 'Wrap', page 91.

7 Configuration

7.1 Introduction

This section describes how to access the recorder's configuration level and make changes to the parameters using the operator keys.

7.2 Configuration Level Security

Two methods of configuration access protection are available:

1. **Password protection** (Factory Default).

The Configuration level cannot be accessed until the correct password has been entered – see Figs. 7.1 and 7.2, pages 66 and 67 respectively.

2. **Internal switch protection.**

The Configuration level cannot be accessed until the internal switch set to the 'Configuration Level Not Protected' position – see Fig. 7.3, page 68.

	'Configuration security' Parameter Setting	
Internal Security Switch Setting (see Fig. 7.3)	'Password protected' (Factory Default)	'Switch protected' (Alternative)
Configuration Level Protected (Factory Default)	Password Access	No Access
Configuration Level Not Protected	Free Access	Free Access

Table 7.1 Configuration Security Modes

The recorder can be configured for one of two levels of password protection:

Basic Security:

- Up to 4 users
- Each user is assigned a unique 4-digit security code for Configuration level access
- Optional security code protection of access to the logging facility

Advanced Security:

- Up to 12 users
- Each user is assigned a unique password of up to 20 characters
- Each user is assigned configuration and/or logging access privileges
- Each user is assigned one of 3 levels of configuration level access privileges
- Configurable password expiry times, password failure limits and minimum password length
- Inactive user disabling

7.3 Configuration Level Access

To configure the recorder when 'Configuration security' is set to the factory default setting of 'Password protected':

1. Access the Configuration Level – see Figs. 7.1 and 7.2, pages 66 and 67 respectively.
2. Make changes to parameters as detailed in Figs 7.5 and 7.6 (pages 70 and 71 respectively) and on-line help.

To configure the recorder when 'Configuration security' is set to 'Internal switch protected':

1. Set the internal security switch to the 'Configuration Level Not Protected' position – see Fig. 7.3, page 68.
2. Access the Configuration Level – see Figs. 7.1 and 7.2, pages 66 and 67 respectively.
3. Make changes to parameters as detailed in Figs 7.5 and 7.6 (pages 70 and 71 respectively) and on-line help.

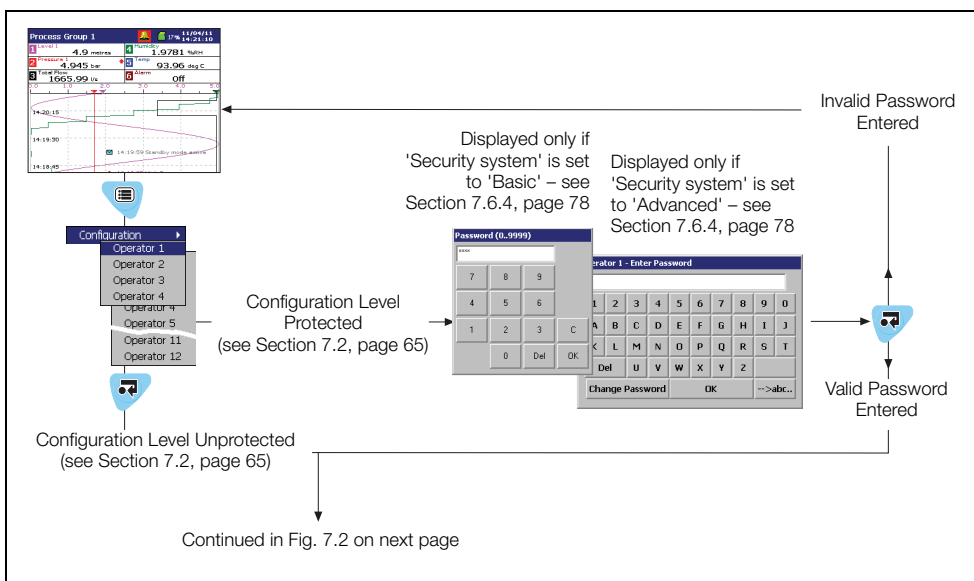

Fig. 7.1 Accessing the Configuration Level

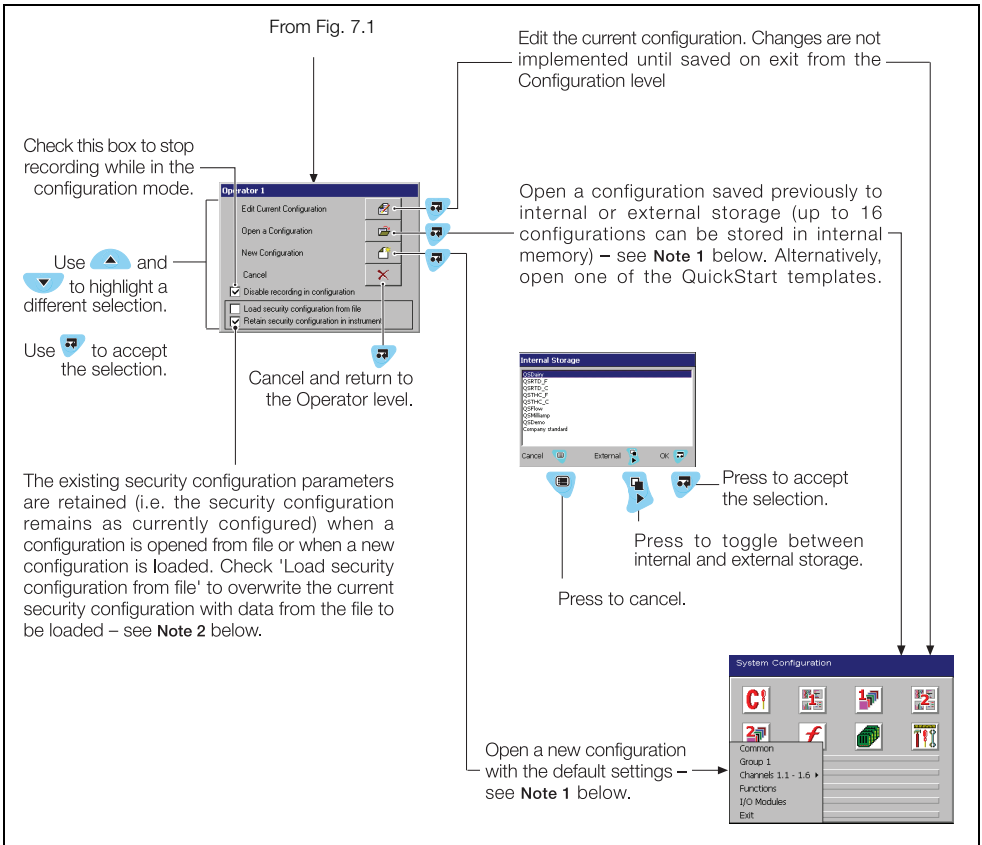

Fig. 7.2 Accessing the Configuration Level

Note.

1. If 'New Configuration' or 'Open a Configuration' is selected and the modified configuration file is saved later as the current configuration, new internal data files for all enabled recording channels are created and any unarchived data is lost.
2. The option to load or retain the security configuration applies only to Advanced Security mode and is available only to the System Administrator (User 1). If a new or existing configuration file is opened by a user other than the System Administrator, the recorder's existing security settings are retained.

Referring to Fig. 7.3, set the internal security switch as follows:

- 1 Unlock the recorder's door with the key supplied, press the release catch and open the door.

Warning. Before proceeding to step 2, isolate the recorder from the power supply.

- 2 Remove the tamper-evident seal (if fitted), release the captive screw securing the inner cover plate and remove the inner cover plate.
- 3 Set the Security switch to the 'Configuration Level Not Protected' position (toward bottom of recorder).

Note. The Internal Security Switch is used to access the Configuration level when 'Configuration security' is set to 'Switch protected'. **Do Not** use the switch to access the Configuration level when 'Configuration security' is set to 'Password protected' (default setting) unless the Password has been forgotten. The switch overrides Password protection, enabling free access to the Configuration level.

- 4 Locate the inner cover plate lugs in the slots in the outer case and close the inner cover plate.
- 5 Tighten the inner cover plate retaining screw and fit a tamper-evident seal (if required).
- 6 Close and lock the recorder's door and restore the power supply to the recorder.

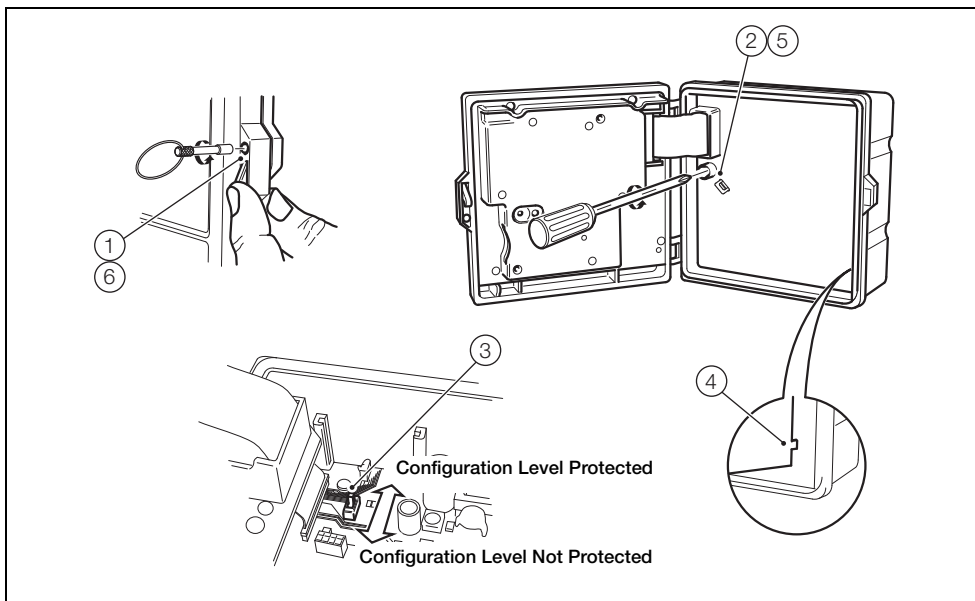





Fig. 7.3 Setting the Security Switch

7.4 Overview of Configuration

Referring to Fig. 7.4, configure the recorder as follows:

- ① Select 'Common' from the Configuration menu.

Note. Only enabled Process Groups (and their associated Channel Options) and enabled software options (i.e. Math and Logic) are visible in the menu.

- ② Select the parameter required using the ▲ and ▼ keys.
- ③ Press the  key to edit selected parameter.
- ④ Use the ◀ and ▶ keys to select the next required tab.
- ⑤ Press the  key to display the menu. Select the next item required and activate using the  key.
- ⑥ When all configuration changes are complete, select 'Exit' to save or cancel changes.

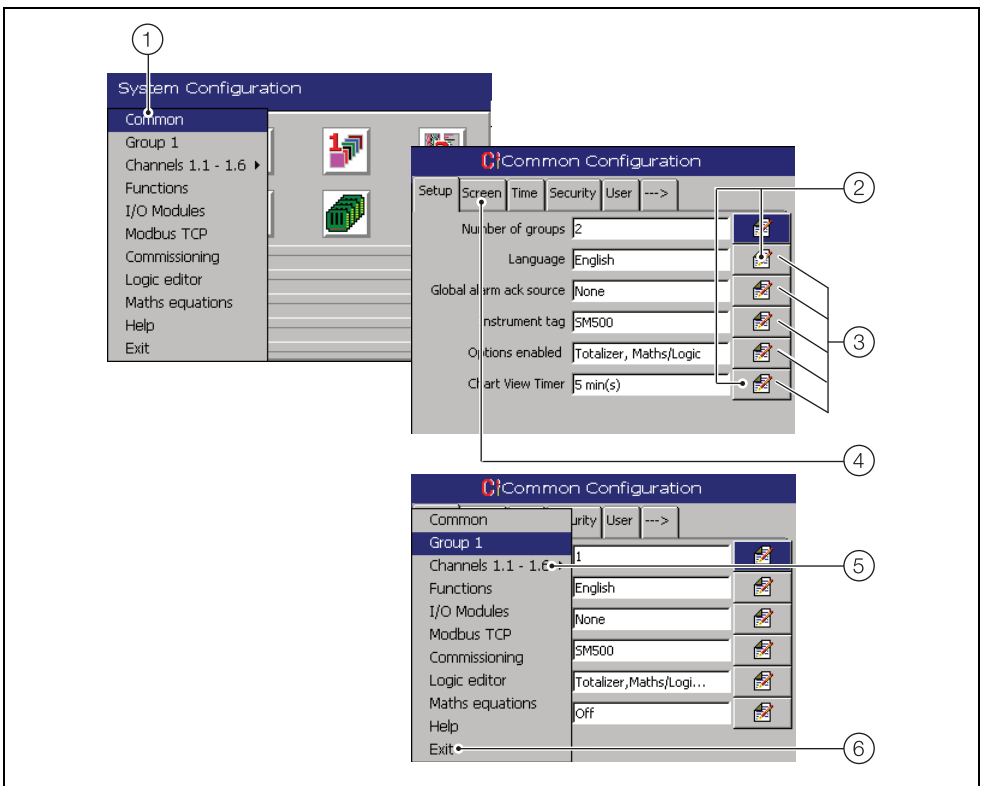





Fig. 7.4 Overview of Configuration Steps

7.5 Making Changes to Parameters

Referring to Fig. 7.5, parameters are located as follows:

- ① Configuration tab.
- ② Parameter.
- ③ Parameter value.
- ④ Edit button.
- ⑤ Sub-menu.
- ⑥ Higher-level windows remain visible to identify location within the configuration structure.
- ⑦ Selection list.
- ⑧ Use the  and  keys to highlight a selection. Press the  key to accept the selection.

Note.

- The appropriate data entry box is displayed automatically.
- Use the  key to open the Configuration menu in order to select a different channel.

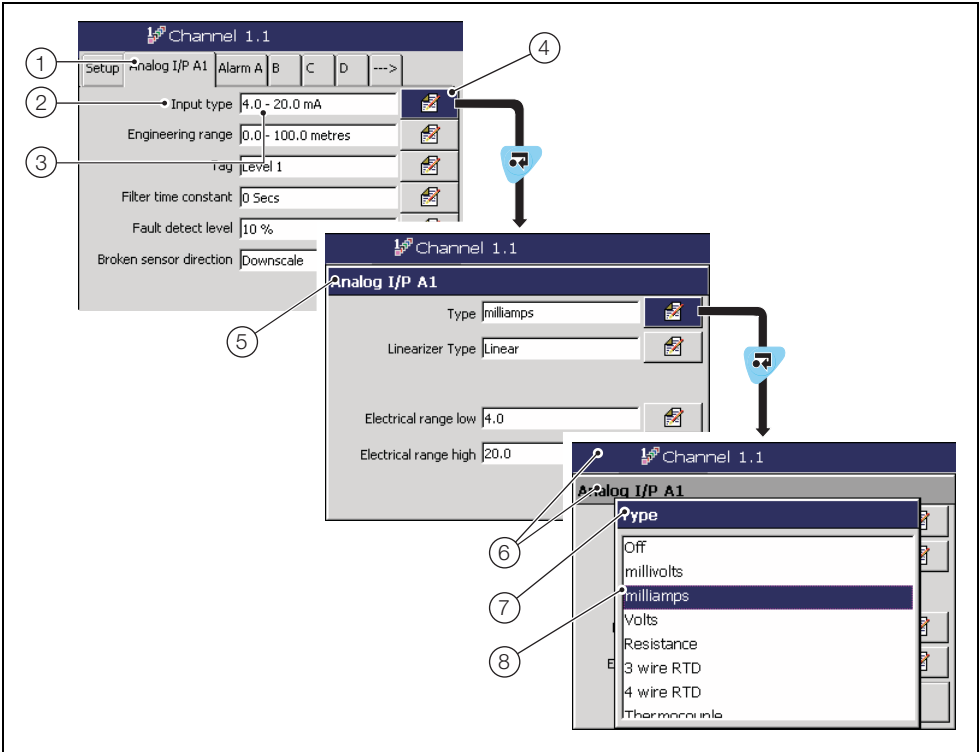

Fig. 7.5 Locating Parameter Settings

Note.

1. Items not selected are indicated by an X in the parameter value window.
2. Values outside the preset parameter limits or with too many decimal places are highlighted when the OK button is selected.

Referring to Fig. 7.6, use data entry dialog boxes as follows:

- ① Use the ▲ and ▼ keys to highlight an item and press ⏎ to select it.
- ② Parameter limits.
- ③ Use the ▲ and ▼ keys to highlight the text field and use the ◀ and ▶ keys to position the cursor to edit text as required.
- ④ Cursor.
- ⑤ Use the ▲, ▼, ◀ and ▶ keys and press ⏎ to highlight a character and press ⏎ to select it.
- ⑥ Spacebar.

Note. Tags with a high percentage of capital letters and wide characters such as 'W' or 'M' may appear truncated in some Operator views. In such cases, use lower case letters or fewer characters.

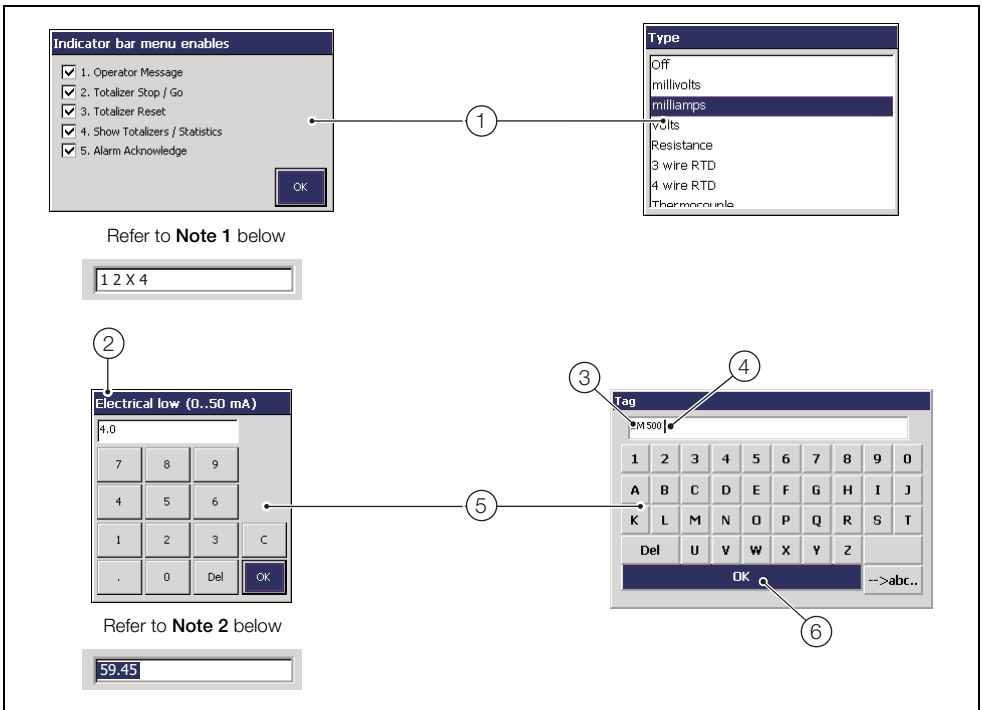

Fig. 7.6 Data Entry Dialog Boxes

Referring to Fig. 7.7, page 73, exit configuration mode as follows:

- ① Open the menu, select 'Exit' and press .
- ② To begin using a configuration immediately, select 'Save as Current Configuration'.

Note.

- When saving the current configuration to internal storage, it is saved twice, once with the filename 'SM500F.cfg' and again with the filename '<time><date><instrument tag>.cfg'
- When saving the current configuration to external storage, it is saved with the filename '<time><date><instrument tag>.cfg'. It is also saved automatically to internal storage with the filename 'SM500F.cfg'.
- When 'Save Configuration' is selected, the configuration file is saved with the filename '<time><date><instrument tag>.cfg' to either selected location, internal or external.
- Changes are saved to non-volatile memory only when one of the save options above has been selected. Any powerdown before this results in lost configuration changes.
- Selecting 'Cancel' discards unsaved changes and returns the recorder to the Operating level.
- New internal data files for enabled recording channels are created if:
 - A recording channel source parameter is changed
 - The primary and/or secondary sample rates and/or their sources for either process group are changed.
 - The input filter type parameter for any channel is changed
 - the engineering range parameter for any channel is changed
 - A channel tag parameter is changed
 - The number of process groups is changed
 - A previously disabled channel is enabled

A warning is displayed if a configuration change will result in the creation of new data files. Select 'Yes' to accept the changes or 'No' to reject them.

- Selecting 'Save as Current Configuration' suspends recording for a short time while the new configuration is implemented.

- ③ Select 'Save configuration' to save any changes but to continue to use the previous configuration.
- ④ Save the configuration in internal or external storage.

Note.

- A configuration file is saved with the filename '<time><date><instrument tag>.cfg'
- When a **current** configuration is saved to external storage, it is also saved automatically to internal storage.

- ⑤ Select 'Cancel' to discard all changes and return to the Operating level.

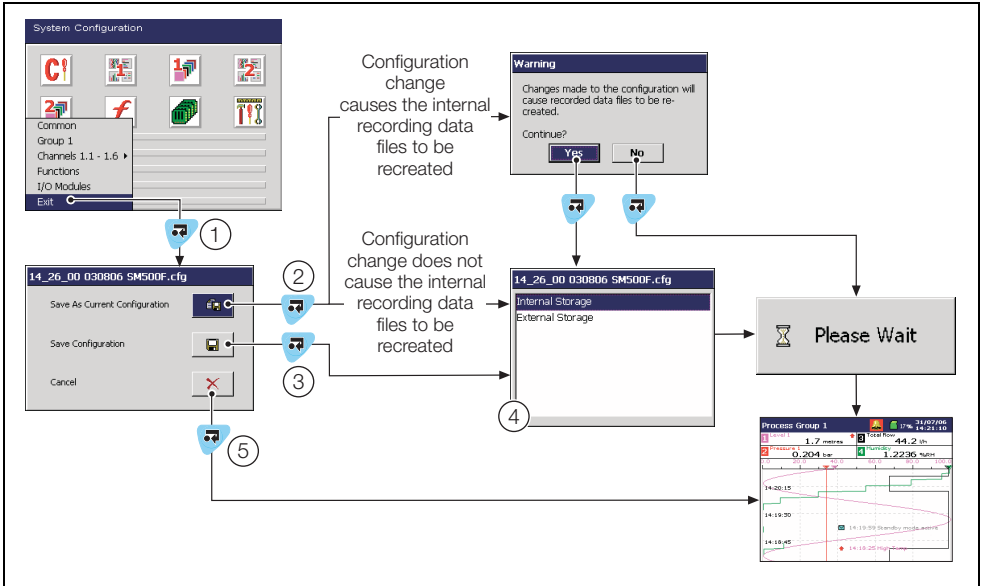

Fig. 7.7 Exiting Configuration Mode

7.6 Common Configuration

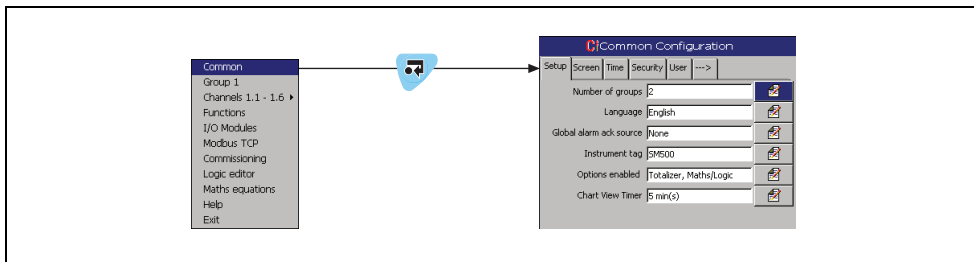
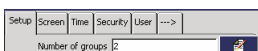

Fig. 7.8 Selecting Common Configuration

7.6.1 Setup



Highlight the  button and press  to toggle the number of process groups required.

Each process group can have up to 6 recording channels assigned to it – Group 1 (Ch1.1 to 1.6), Group 2 (Ch2.1 to 2.6).

If the Number of Groups is changed from 2 to 1, configuration data for Process Group 2 is retained but not used.



Select the language to be used to display standard user prompts and menu items.

Note. A new language selection does not take effect until the configuration is saved.



Select a signal source used to acknowledge all active alarms in both Process Groups simultaneously. refer to Appendix A, page 146 for a description of the available sources.

Note. This signal is edge-triggered. A rising edge (inactive to active) or falling edge (active to inactive) triggers global alarm acknowledgement.

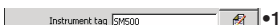

Enter the tag to be used to identify the recorder on configuration and audit log files.

Note. When reviewing data, the instrument tag is used to identify the source of the data, therefore it is important to ensure that the instrument tag is unique to each recorder.

- 1 If this parameter is changed, internally recorded data files are recreated and unarchived data is lost.

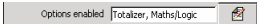

Displays the optional functionality (Totalizers and/or Math & Logic and/or Batch recording) enabled on the recorder.

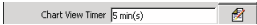

If set to anything other than 'Off', initiates AutoView Scroll automatically (for the Chart view only) after the time selected has elapsed.

The AutoView Scroll icon () is displayed in the status bar at the top of the screen and the Chart view for each configured process group is displayed in turn for 20 seconds. Press any key to cancel AutoView Scroll.

7.6.2 Screen

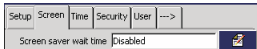

Select the waiting time between the last key press and activation of the screen saver.

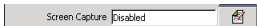

When set to 'Enabled', the user can save an image of any Operator screen to external archive media by pressing the  key when an Operator menu is not open.

Note.

- All images are saved to a folder on the archive media named 'BMP'.
- The images are saved even if archiving is set to 'Offline'.
- If external archive media is not inserted, or is full, the screen capture facility is disabled automatically.

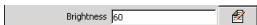

Adjust screen brightness.

7.6.3 Time

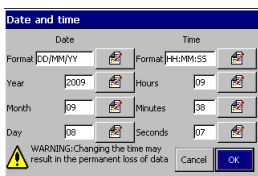
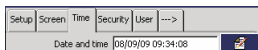

Set the date and time formats and set the current date and time using the dialog box.

Note.

- If daylight saving is required, enter the settings (see next page) **before** setting the time and date as the operation of the internal clock is affected by the daylight saving settings.
- The date and time cannot be adjusted if recording is enabled during configuration, i.e the 'Disable recording in configuration' check box is **not** ticked on entry to the Configuration level – see Fig. 7.2, page 67.
- Changes to the date and time are effective immediately upon selecting 'OK' in the dialog box. Select 'Cancel' in the dialog box to exit date and time setup without saving changes. Selecting 'Cancel' upon exiting Configuration Mode (see Fig. 7.7, page 73) **does not** reset the clock to its previous setting.
- Setting an earlier date or time results in the loss of all data currently in the internal buffer memory past that date. Data archived to external media is unaffected. If an earlier time must be set, change the Instrument Tag (see page 74). This causes new archive files to be created and the duplicated hour of data is then saved to the new files.
- Time changes due to automatic daylight saving do not affect the recorded data.
- Archive files created during the daylight saving period (see Section 7.7.4, page 90) are compatible with the database feature of Version 6.2 (or later) only of the Company's DataManager data analysis software package.
- If the  status icon is displayed the clock battery must be replaced – contact factory.

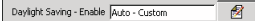

Select the daylight saving method.

Note. Changes to daylight saving are effective immediately a method is selected. However, if 'Cancel' is selected upon exiting Configuration Mode (see Fig. 7.7, page 73), the last saved daylight saving settings are restored.

Off	Daylight saving is disabled.
Auto - USA	The start and end of the daylight saving period in the USA is calculated automatically. The clock is incremented automatically by 1 hour at 2:00am on the second Sunday in March and decremented automatically by 1 hour at 2:00am on the first Sunday in November.
Auto - Europe	The start and end of the daylight saving period in Central Europe is calculated automatically. The clock is incremented automatically by 1 hour at 2:00am on the last Sunday in March and decremented automatically by 1 hour at 2:00am on the last Sunday in October.
Auto - Custom	The start and end of the daylight saving period can be configured manually for regions that do not follow either the USA or Europe conventions. The clock is incremented automatically by 1 hour at the manually selected start time and decremented automatically by 1 hour at the manually selected end time.

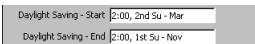

Note. Displayed only if 'Daylight Saving - Enable' is set to 'Auto - USA'.

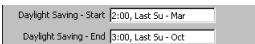

Note. Displayed only if 'Daylight Saving - Enable' is set to 'Auto - Europe'.

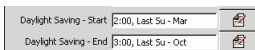

Note. Displayed only if 'Daylight Saving - Enable' is set to 'Auto - Custom'.

Set the start and end of the daylight saving period.

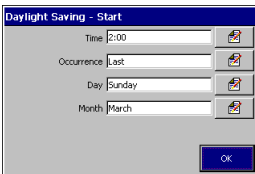

7.6.4 Security

Note. User 1 is the System Administrator and is able to change the Security type and all other security parameters. Other users can change only the 'Logging level security' setting and only if 'Security system' is set to 'Basic'.



Set the Security type.

Select Basic or Advanced security – see Section 7.2, page 65.

Set the method of access to the Configuration level.

- If 'Password protected' is selected, access is by means of the password set for the user – see Section 7.6.5, page 80.
- If 'Switch protected' is selected, access to the Configuration level for all users is prohibited once the changes have been saved and made active. Access to the Configuration level is then achieved only by setting the internal security switch to the 'Configuration Level Not Protected' position – see Fig. 7.3, page 68.

Note. The 'Logging security' and 'Acknowledge Security' fields (see below) are displayed only if 'Security system' is set to 'Advanced'.

When 'Logging security' is set to 'On', access to the Logging level is protected by each user's unique password.

When 'Acknowledge Security' is set to 'On', each user must enter their unique password in order to acknowledge alarms.

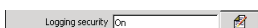

Note. Displayed only if 'Security system' is set to 'Basic' – see above.

When set to 'On', access to the Logging level is protected by a single password for all users.



Note. Displayed only if 'Security system' is set to 'Basic' **and** 'Logging level security' is set to 'On' – see above.

Enter the password to be used by all users to access the Logging level.

Note. The following parameters:

- are displayed only if 'Security system' is set to 'Advanced' – see above.
- can be changed only by the System Administrator (User 1).

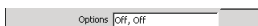

Indicates status of Logging and Acknowledge security settings – see above.

Reconfigure preset: 

Passwords are entered initially by the System Administrator but, subsequently, any user can change their own password. When this parameter is set to 'Yes', each user must change their password after it is used for the first time following initial configuration – see also Section 7.6.5, page 80.

Password expiry: 

Enter the time period after which all passwords expire. After this period of time, all users must change their passwords.

Inactive user disabling: 

Enter the time period after which an inactive user's access privileges are de-activated. A user is considered inactive if their password has not been used. A user is de-activated by removal of their access privileges and can be re-activated only by the System Administrator (User 1).

Password failure limit: 

Enter the number of consecutive incorrect password entries allowed by a user. If the number of incorrect entries exceeds this limit, the user's access privileges are de-activated and can be reinstated only by the System Administrator (User 1).

Min password length: 

Passwords have a maximum length of 20 characters. Enter the minimum length required for all new passwords.

7.6.5 Users

Note.

- User 1 is the System Administrator and is able to change user names/access privileges and enter initial passwords for all other users.
- if 'Security system' is set to 'Basic' (see Section 7.6.4, page 78) other users (if enabled by User 1) can change their user name, password and access privileges.
- if 'Security system' is set to 'Advanced' (see Section 7.6.4, page 78), other users cannot change their user names and access privileges once set by User 1, but all users may change their own passwords.
- The following parameters are displayed only if 'Security system' is set to 'Basic' – see Section 7.6.4, page 78.

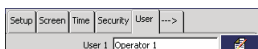

Enter a name and password for User 1.

Note. User 1 only is able to access this parameter.

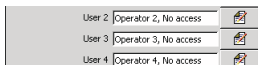

User 1 can enter names and associated passwords to enable up to 3 additional users access to the Configuration level.

Note. If enabled by User 1, another user can access their associated parameter and change the 'Name', 'Password' and 'Access' settings. However, if 'Access' is set to 'Disabled' by that user and the configuration saved, only User 1 can restore that user's access privileges.

Enter a name for the selected user.

Enter an initial password for the selected user.

Set access privileges for the selected user.

Enabled – The selected user is able to access the Configuration level.

Disabled – The selected user is unable to access to the Configuration level.

Note. When the method of access to the Configuration level is set to 'Password protected' (see Section 7.6.4, page 78) and a user with Configuration level access privileges changes the recorder's configuration, the 'Name' of the user is included in the audit log entry.

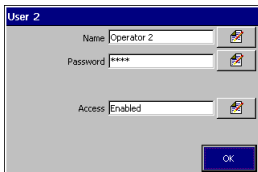

Note. The following parameters are displayed only if 'Security system' is set to 'Advanced' – see Section 7.6.4, page 78.

Configure User 1 (System Administrator)

Note. Full Configuration level access privileges for User 1 cannot be disabled.

Select e-Sign, Logging, Batch (see Appendix F, page 173) and Alarm acknowledge access privileges as required (see also page 82).

The System Administrator (User 1) can view and/or change the user name, access privileges and password for any other user. Select the user to be viewed/edited.

Enter a name for the selected user.

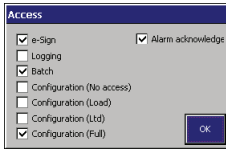

Set access privileges for selected user.

- e-Sign – The selected user is able to enter an electronic signature.
- Logging – The selected user is able to access the Logging level.
- Batch – The selected user is able to start and stop batch recording – see Appendix F.3, page 174.

Configuration (No access)

- The selected user is unable to access the Configuration level.

Config (Load)

- The selected user is unable to make any configuration changes but can load configurations from external media.

Configuration (Ltd) – The selected user is able to:

- Change alarm trip points, hysteresis and time hysteresis settings.
- Make input adjustments for analog input boards.
- Load configurations from external media only.

Configuration (Full) – The selected user is allowed full configuration access with the exception of access to the Security settings.

Alarm acknowledge – The selected user is able to acknowledge alarms.

Note. The System Administrator (User 1) only is able to change the Security settings.



Enter an initial password for the selected user.

Note. The user may subsequently change this password.

7.6.6 Operator Messages

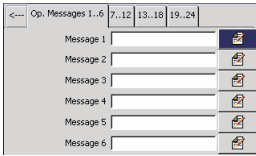

Operator messages can be triggered via the Operator menus or a digital signal.

Message Tag

Enter the message text – 20 characters maximum.

Source ID

Select a signal source used to add the Operator Message to the Alarm Event log. refer to Appendix A, page 146 for a description of the available sources.

Note. This signal is edge-triggered. A rising edge (inactive to active) or a falling edge (active to inactive) triggers the addition of the Operator Message to the Alarm Event log.

Assign to group 1/Assign to group 2

Select the group(s) to which the message is to apply.

7.7 Process Group Configuration

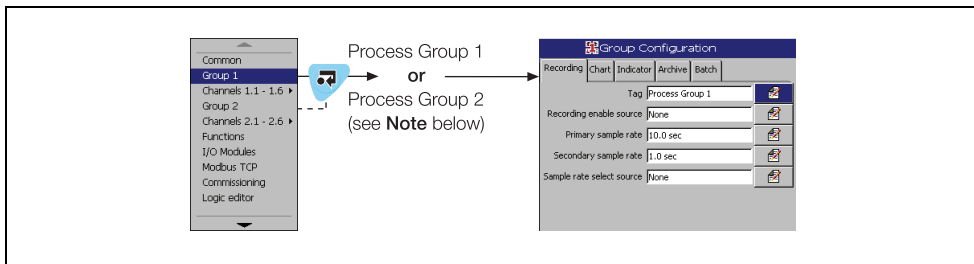
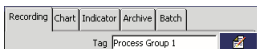

Fig. 7.9 Selecting Process Group Configuration

Note. If 'Number of groups' is set to '1' (see page 74), only one Process Group and its associated channels is displayed in the configuration menu.

7.7.1 Setting the Recording Parameters



Enter the process group tag (maximum 20 characters) that appears in the title bar when any operator views from that group are displayed.

Note. Each process group tag **must** be unique.

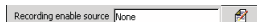

Select a signal source to enable/disable recording of all channels in the current Process Group. refer to Appendix A, page 146 for a description of the available sources.

Note. This signal is edge-triggered. A rising edge (inactive to active) enables recording. A falling edge (active to inactive) disables recording.

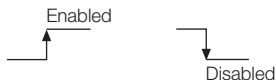

The recorder can be configured to sample all recording channels in the group simultaneously and store the data in internal memory and external archive media (if archiving is enabled) at two rates, Primary and Secondary.

The Primary sample rate is active during normal process operating conditions and is set typically to a relatively slow rate (depending upon process recording requirements) in order to maximize internal memory and external archive media capacity.

The recorder can be configured to switch to a faster (Secondary) sample rate when a selected digital source becomes active in order to record the maximum amount of detail for the period in which that source is active; or it may be switched manually from the 'Logging' Operator menu – see Section 5.2, page 50.

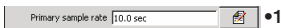

•1 Set the Primary sample rate to between 0.1 seconds and 720 minutes (12 hours). The table below compares example sample rates with the equivalent chart speeds of a traditional chart recorder together with the storage capacity of internal memory. refer to Appendix C, page 162 for full details of internal memory and external archive media storage capacity.

Sample Rate	Equivalent Chart Speed	On-board Storage Time (4 Channels)
1 second	720mm/h	6 days
3 seconds	240mm/h	18 days
6 seconds	120mm/h	1.1 months
12 seconds	60mm/h	2.3 months
36 seconds	20mm/h	7 months
72 seconds	10mm/h	1.2 years

Note.

- Sample rates are set using one of the following combinations of units:
 - Minutes or minutes and seconds
 - Seconds
 - Tenths of seconds (*minutes and seconds must first be set to zero*).
- The rate at which data is displayed in the Chart views is set separately – see 'Screen interval', page 87.
- The fastest sample rate setting determines the maximum screen interval that can be selected – see Table 4.1, page 32.

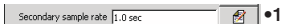

•1 Set the Secondary sample rate to between 0.1 seconds and 720 minutes (12 hours).

•1 If this parameter is changed, internally recorded data files are recreated and unarchived data is lost.

Sample rate select: source [None]  •1

Select a signal source to enable switching between the primary and secondary sample rates. refer to Appendix A, page 146 for a description of the available sources.

Note. This signal is edge-triggered. A rising edge (inactive to active) switches to the secondary sampling rate. A falling edge (active to inactive) switches to the primary sampling rate.

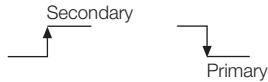

- 1 If this parameter is changed, internally recorded data files are recreated and unarchived data is lost.

7.7.2 Configuring the Chart View



Select Horizontal --> (Chart runs left to right with scale bar on left), Horizontal <--(chart runs right to left with scale bar on right), or Vertical Chart view.



Select the annotations to be displayed on the chart. Alarm events and operator messages are displayed on the chart adjacent to the point at which the alarm occurred – see Section 4.4, page 27.

This initial setting can be changed by the operator if 'Chart annotation select enable' is enabled in the Chart view menu enables – see 'Menu Enables', page 88.

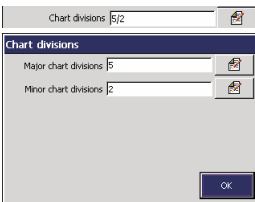

Select the number of major and minor chart divisions to be displayed on the chart and its scale bar.

Select the number of major vertical divisions to be displayed.

Select the number of minor vertical divisions to appear between the major chart divisions.

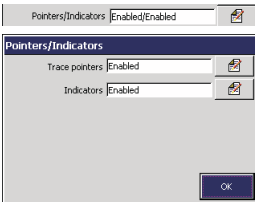

Enable trace pointers to display a chart scale bar with colored pointers (color recorders) or numbered pointers (monochrome recorders) to indicate the instantaneous trace positions.

Disable trace pointers to display the standard chart scale bar.



Note. On monochrome recorders, disabling trace pointers will make individual trace identification difficult.

Enable indicators to display the 6 numbered channel indicators at the top of the screen.

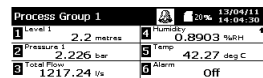

Disable indicators to hide the indicators and enlarge the Chart view.

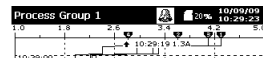
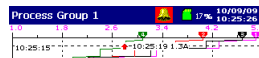

Select the amount of historical data to be displayed on the screen. Available selections are limited by the sample rate selected – see Section 7.7.1, page 84 and Table 4.1, page 32.

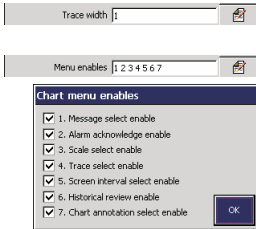

Select the required trace width in pixels.

Select the menu items to be accessible from the Chart view.

Message select enable

Enables the operator to activate one of 24 pre-configured messages or a user-defined message.

Alarm acknowledge enable

Enables the Operator to acknowledge any alarms associated with the current group.

Scale select enable

Enables the operator to display the scale for one enabled channel, or all channels in turn, on the scale bar at the top of the screen.

Trace select enable

Enables individual chart traces to be displayed or hidden.

Screen interval select enable

Enables the Operator to change the amount of data displayed on the screen at one time.

Historical review enable

Enables the Operator to scroll back through data recorded previously that is no longer visible on screen.

Chart annotation select enable

Enables the display of Alarm events and Operator messages on the chart to be enabled or disabled by the operator.

Note. Menu items that are not enabled are greyed-out (color recorders) or blanked out when selected (monochrome recorders) in the relevant Chart view menu.

7.7.3 Configuring the Indicator View



Select 'On' to enable the operator to display the Indicator view.



Note. Available only if the totalizer option is enabled in the software **and** a totalizer for that channel is enabled.

Set to 'On' to add the channel totalizer value and units to the Indicator view.



Set to 'On' to add the Bargraph display to the Indicator view.



Set to 'On' to add the alarm trip point indicators to the Indicator view.

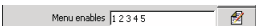

Select the menu items to be accessible from the Indicator view.

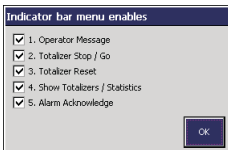

Operator Message

Enables the Operator to activate one of 24 pre-configured messages or a user-defined message.

Totalizer Stop / Go

Enables the Operator to start and stop the totalizers.

Totalizer Reset

Enables the Operator to reset the totalizer value to the preset totalizer value on any or all channels.

Show Totalizers / Statistics

Enables the Operator to change the display to show either the totalizer values or the totalizer maximum, minimum and average values.

Alarm Acknowledge

Enables the Operator to acknowledge any alarms associated with the current group.

Note. Menu items that are not enabled are greyed-out (color recorders) or blanked out when selected (monochrome recorders) in the Indicator view menu.

7.7.4 Archiving

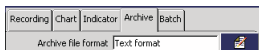

Select the archive file format required – Text format or Binary format.

Note.

- The selected archive file format is applied automatically to **both** process groups. It is not possible to set each group to different formats.
- If 'Enable Batch Recording' on the 'Batch' tab is set to 'On', the archive file format is set automatically to 'Binary format' and cannot be changed.

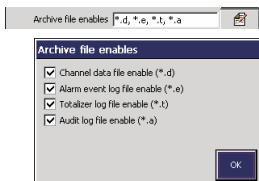

Select the data types that are to be archived to the storage media: Channel Data; Alarm Event log; Totalizer log; Audit log.

Note.

- The totalizer log file can be enabled only if the totalizer option is enabled.
- Batch log files are generated automatically if batch recording is enabled and cannot be de-selected.

File Type	Contents	Extension
Channel data files	Analog or digital recording channel signals in the current process group	*.D00 (Text) or *.B00 (Binary)
Alarm event log files	The historical record of the alarm events related to the group's channels plus the history of any operator messages, electronic signatures or real time alarms.	*.E00 (Text) or *.EE0 (Binary)
Totalizer log files	The historical record of all totalizer and associated statistical values relating to the group's recording channels.	*.T00 (Text) or *.TE0 (Binary)
Audit log files	The historical entries in the audit log.	*.A00 (Text) or *.AE0 (Binary)

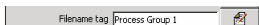

Note. Displayed only if 'Archive file format' is set to 'Text format'.

Enter the filename (max. 20 characters) to be used to identify the channel data archive files.

Note. The following characters cannot be used in the filename tag: \, /, :, *, ?, ", <, >, |, superscript characters, ~, Ω and °. These are greyed-out (color recorders) or blanked out when selected (monochrome recorders) on the keyboard.



Note. Displayed only if 'Archive file format' is set to 'Text format'.

Set the frequency with which new channel data files are created.

Note. Set automatically to 'Off' if 'Wrap' (see next page) is set to 'On'.

New File Interval	Filename
Hourly	<hour> <day, month, year>* <filename tag>
Daily	<day, month, year>* <filename tag>
Monthly	<month, year>* <filename tag>
None	<filename tag>

*Formatted according to the date format set in Common Configuration – see Section 7.6.3, page 76.

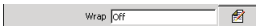







When set to 'On', archive wrap deletes automatically the oldest archived data file from external archive media when the media approaches its maximum capacity.

When set to 'Off', archiving stops automatically when external archive media is full. No files are deleted.

Archive Triggers	Oldest Un-archived Data	
	<1 Day Old (Binary) or <1 Hour Old (Text)	>1 Day Old (Binary) or >1 Hour Old (Text)
'Online' request from the Logging menu.	Any un-archived data is stored automatically to the removable archive media.	All the un-archived data within the selected time frame is archived. Older un-archived data remains in the internal memory buffer until overwritten by newer data but is not available for archiving to removable media.
Automatic update	Any un-archived data is saved to removable archive media at regular intervals (approximately every 30 seconds).	Not Applicable

Table 7.2 Archive Triggers

7.7.5 Batch Recording

Recording	Chart	Indicator	Archive	Batch
Enable Batch Recording		On		
Start/Stop, Abort		Real time alarm 1, 1 min...		
Operator Login		Disabled		
Batch Number		Automatic		
Field 1 Title		BLACK		
Field 2 Title		BELL		
Field 3 Title		OCEAN		

See Appendix F, page 173.

7.8 Channel Configuration

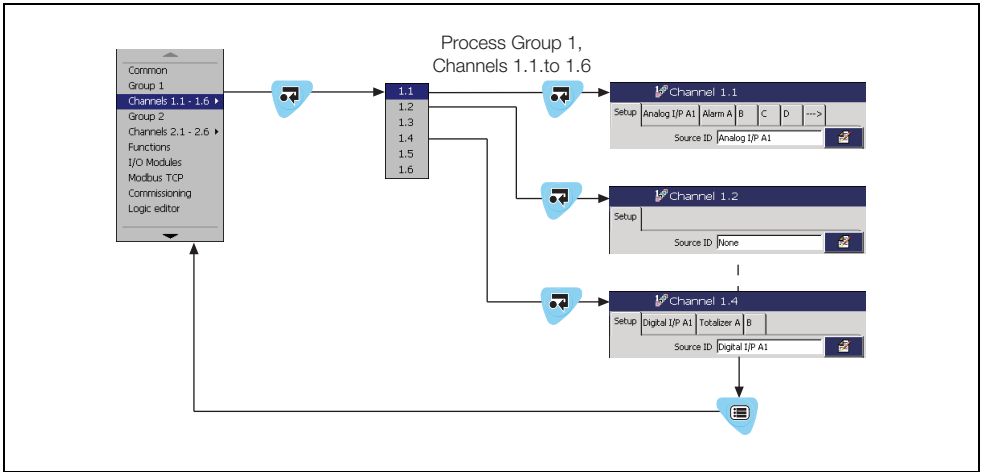
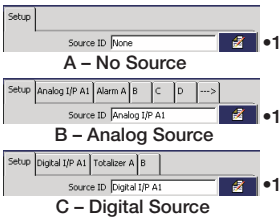

Fig. 7.10 Recording Channel Configuration

7.8.1 Recording Channel Setup



Select the signal source for the selected channel. This can be any external analog or digital signal – see Appendix A, page 146 for full list.

Note.

- The input source for Channel 1 in any process group **must** be an analog source to ensure correct operation of the recorder.
- The tabs change according to the selection made.
- Setting a channel source to 'None' does not switch off the analog input to which the channel was assigned previously i.e. the analog input continues to be monitored. To switch off an analog input, set Analog I/P 'Type' for the required channel to 'Off' – see Section 7.8.2, page 96.

- 1 If this parameter is changed from any previous setting other than 'None', a new internal data file for this recording channel is created. All historical data stored internally for this channel is lost. If this parameter is changed from a previous setting of 'None' new internal data files for all enabled recording channels are created. Any unarchived data is lost.

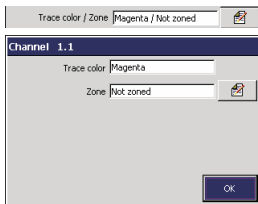

Select the color used to display the trace and its tag on Chart and Indicator views. Trace colors can be selected from the following:

Magenta, Red, Black, Green, Blue, Brown, Cyan, Yellow, Light Green, Dark Cyan, Dark Yellow, Dark Blue.

Note. On a monochrome recorder, all traces appear in black but the recorder's in-built web server displays all traces in color on a PC monitor.

Each recording channel can be configured to position its trace in one of 9 specific zones in the Chart views in order to separate traces that would otherwise be very close to each other.

Select one of the pre-defined zones available.

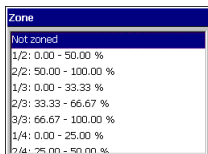

Select the filter to be applied to the electrical input prior to sampling.

Note.

- Applicable to analog sources only.
- Filters are applied to the recorded values shown on the Chart view only, not to instantaneous values displayed on the channel indicators.

Instantaneous – A single value based on process conditions at the time of sampling.

Average – The average value of the analog signal since the previous sample.

Minimum – The minimum value of the analog signal since the previous sample.

Maximum – The maximum value of the analog signal since the previous sample.

Max & min – Two values are recorded to capture the maximum & minimum signal values since the previous sample. This allows the memory use to be extended by permitting a slower sample rate to be selected without losing the transient behavior of the signal.

•1 If this parameter is changed, internally recorded data files are recreated and unarchived data is lost.



Select the type of scale displayed in the Chart view and the format of the current value readings displayed in both Chart and Indicator views.

- Linear – normal linear scale displayed in the Chart view; normal current value readings displayed in both Chart and Indicator views.
- Log – logarithmic scale displayed in the Chart view; current value readings displayed in exponential format. For example, 2.4E+4 (2.4×10^4) is displayed in both Chart and Indicator views.

Note.

- For further information on the use of this feature, refer to Appendix E.4, page 172.
- The following parameters are displayed only if this parameter is set to 'Log'.



Select the lower limit of the log decade range to be displayed on the Chart view scale – refer to Appendix E.4, page 172.

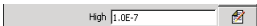

Select the upper limit of the log decade range to be displayed on the Chart view scale – refer to Appendix E.4, page 172.

7.8.2 Analog Input Configuration

Note.

- The 'Analog I/P' tab is displayed only if 'Source ID' for the Recording Channel is set to an analog signal source – see Section 7.8.1, page 93.
- If an analog input is assigned to more than one recording channel, changes to any of its parameters and tags are applied to each channel the input is assigned to.
- If an analog input is already assigned to another channel, the edit keys () are not available.

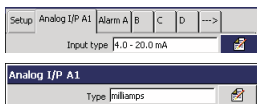

- 1 Select the electrical characteristics of the input.

Note.

- Simulated input types are available for evaluating recorder features without the need for process connections.
- If 'Volt free digital input' is selected, the input channel becomes a digital input channel – see Section 7.8.3, page 99.
- Select 'Off' to disable an analog input.

Warning. Ensure that the appropriate electrical connections have been made – see Section 2.3, page 14.

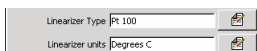

Select the linearizer type and the units used to condition the input signal before it is sampled.

Note.

- For thermocouple applications using an external fixed cold junction, set 'Type' to 'millivolts' and select the appropriate linearizer type.
- Linearizer units are displayed only if a temperature linearizer type (Thermocouple or RTD) is selected.

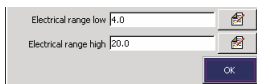

Set the required electrical range.

Note.

- Applicable only to mA, mV, V and Resistance input types.
- The range of the electrical input signal is determined by the input type – see Table 7.3:

Input Type	Standard Inputs			
	mV	V	mA	Ω
Min.	0	0	0	0
Max.	150	20	50	5000

Table 7.3 Limits of Electrical Ranges

- 1 If this parameter is changed to or from 'Volt free digital input', internally recorded data files are recreated and unarchived data is lost.

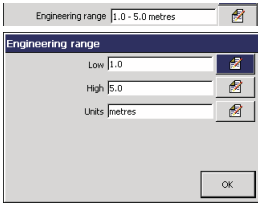

Specify the display range and units of the engineering value corresponding to the electrical high and low values, within the limits defined in Table 7.4:

THC/RTD Type	°C		°F	
	Min.	Max.	Min.	Max.
B	-18	1800	0	3270
E	-100	900	-140	1650
J	-100	900	-140	1650
K	-100	1300	-140	2350
L	-100	900	-140	1650
N	-200	1300	-325	2350
R & S	-18	1700	0	3090
T	-250	300	-400	570
Pt100	-200	600	-325	1100
Power 5/2 Power 3/2 Square Root Custom Linearizer 1 Custom Linearizer 2 Linear	-999 to +9999			

Table 7.4 Limits of Engineering Ranges

Example – for an electrical input range of 4.0 to 20.0mA, representing a pressure range of 50 to 250 bar, set the 'Low' value to 50.0 and the 'High' value to 250.0.

Note.

- Select any of the engineering units pre-programmed into the recorder or select 'Custom' and enter user-defined units (6 characters max.). Refer to Appendix D, Table D.1, page 163 for a description of the pre-defined engineering units.
- The recorder can be configured to calculate the totalizer count rate automatically by ensuring that the engineering range unit of measurement selected for the channel to which the totalizer is assigned is a volumetric unit (i.e. quantity per unit of time, for example gallons per hour) – see page 107. If the recorder holds the relationship data between the selected measurement units and totalizer units, the count rate parameter is calculated and displayed automatically.

•1 If this parameter is changed, internally recorded data files are recreated and unarchived data is lost.



•1

Enter the tag name to be displayed in the Chart and Indicator Views and used to identify the channel in archive files (20 characters max.).

Note. Tags with a high percentage of capital letters and wide characters such as 'W' or 'M' may appear truncated in some Operator views. In such cases, use lower case letters or fewer characters.

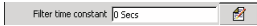

Set the time period over which the process variable is to be filtered prior to being sampled (0 to 60 seconds).

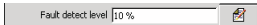

Set a tolerance level (between 0 and 100% of the engineering range) to allow for deviation of the input signal above or below the input span before an input failure is detected.

Example – setting the fault detection level to 10% on an input range of 50 to 250 bar causes an 'Analog Input Failure' fault to be detected below 30 bar and above 270 bar.



In the event of an input failure, recorder channels can be set to drive upscale, downscale or in the direction of failure.

- Upscale – channel value driven beyond full scale.
- None – driven in direction of failure.
- Downscale – channel value driven below zero.

•1 If this parameter is changed, internally recorded data files are recreated and unarchived data is lost.

7.8.3 Digital Input Configuration

Note. The 'Digital I/P' tab is displayed only if 'Source ID' for the Recording Channel is set to a digital signal source – see Section 7.8.1, page 93.

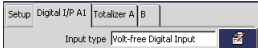

•1 **Note.** This parameter is displayed only if 'Input type' on the 'Analog I/P' tab (see page 96) is set to 'Volt free digital input*'. If this parameter is changed to anything other than 'Volt free digital input', the input channel reverts to an analog input channel – see page 96.

* 24V Digital i/P



Enter the tag to be displayed on channel indicators when the digital signal is active (6 characters max.).

Note. Tags with a high percentage of capital letters and wide characters such as 'W' or 'M' may appear truncated in some Operator views. In such cases, use lower case letters or fewer characters.

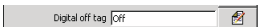

Enter the tag to be displayed on channel indicators when the digital signal is inactive (6 characters max.).

Note. Tags with a high percentage of capital letters and wide characters such as 'W' or 'M' may appear truncated in some Operator views. In such cases, use lower case letters or fewer characters.



Enter the tag name to be displayed in the Chart and Indicator views and used to identify the channel in archive files (16 characters max.).

Note. Tags with a high percentage of capital letters and wide characters such as 'W' or 'M' may appear truncated in some Operator views. In such cases, use lower case letters or fewer characters.

•1 If this parameter is changed, internally recorded data files are recreated and unarchived data is lost.

7.8.4 Alarm Configuration

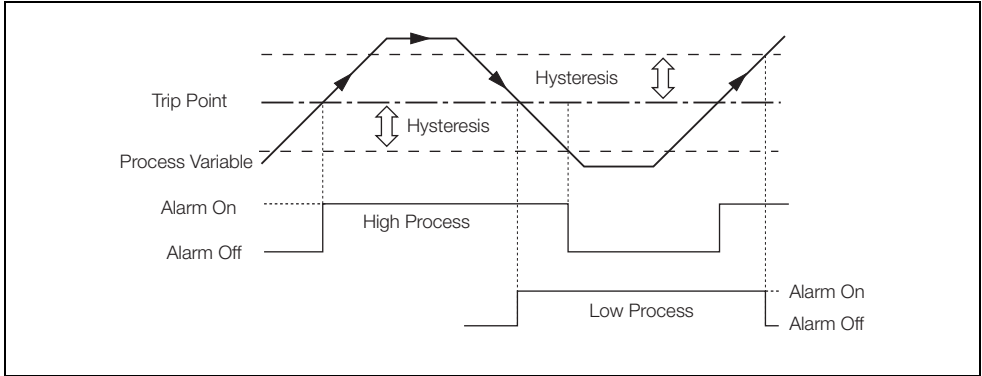
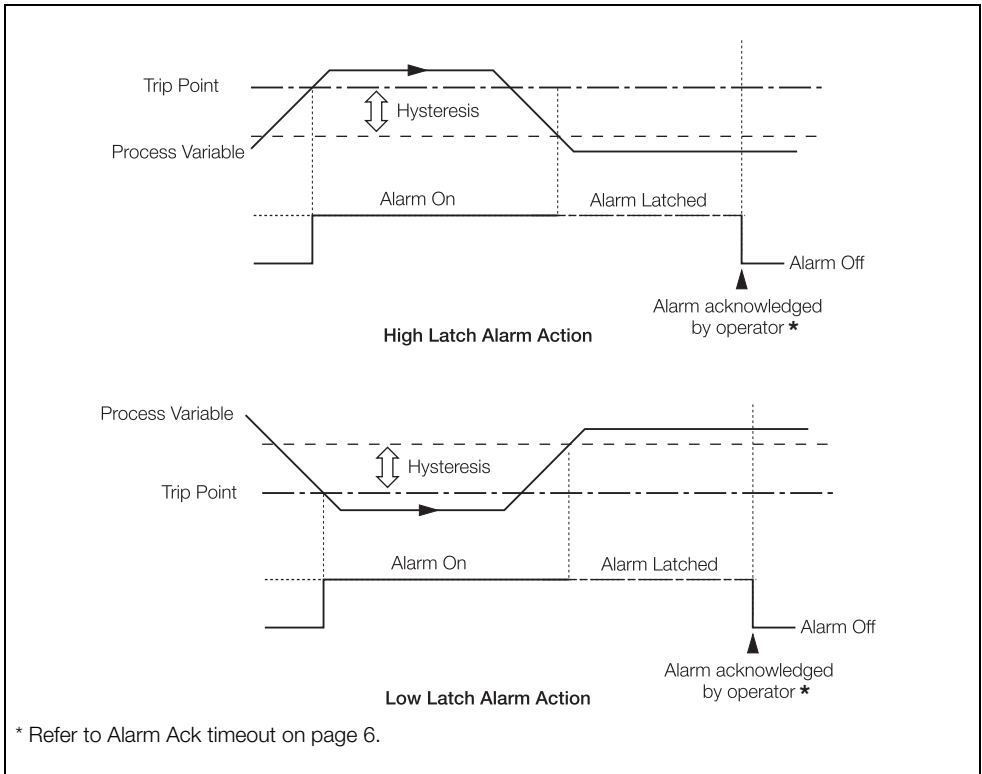

Fig. 7.11 High/Low Process Alarms



* Refer to Alarm Ack timeout on page 6.

Fig. 7.12 High/Low Latch Alarms

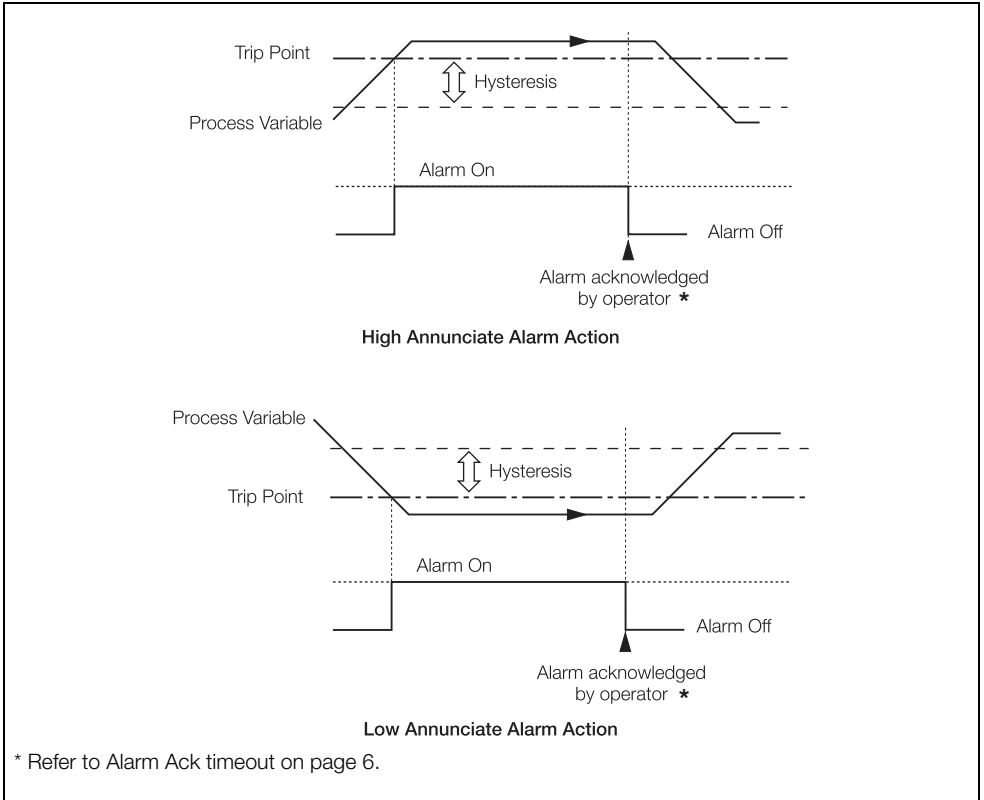

Fig. 7.13 High/Low Annunciate Alarms

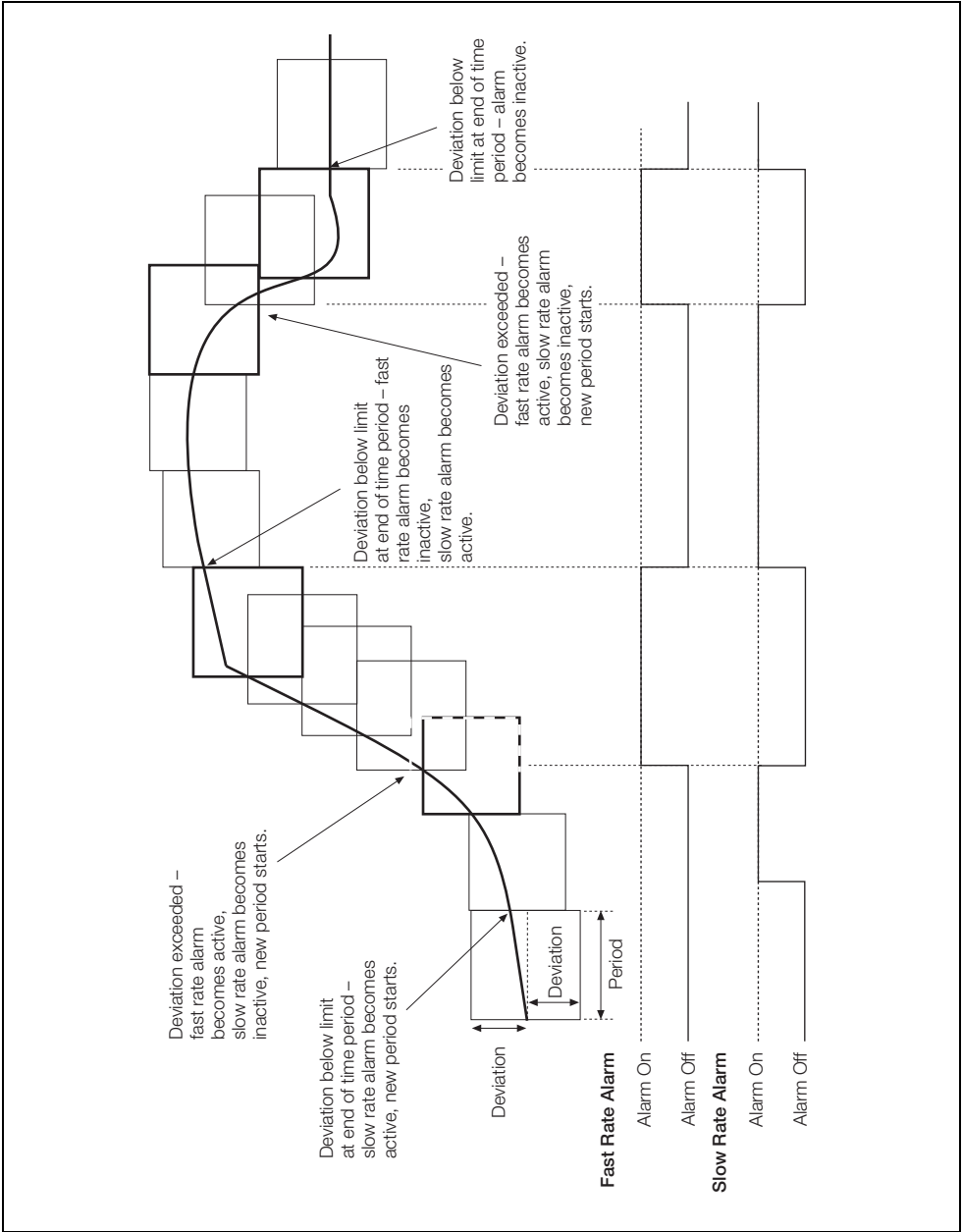

Fig. 7.14 Fast-/Slow-Rate Alarms

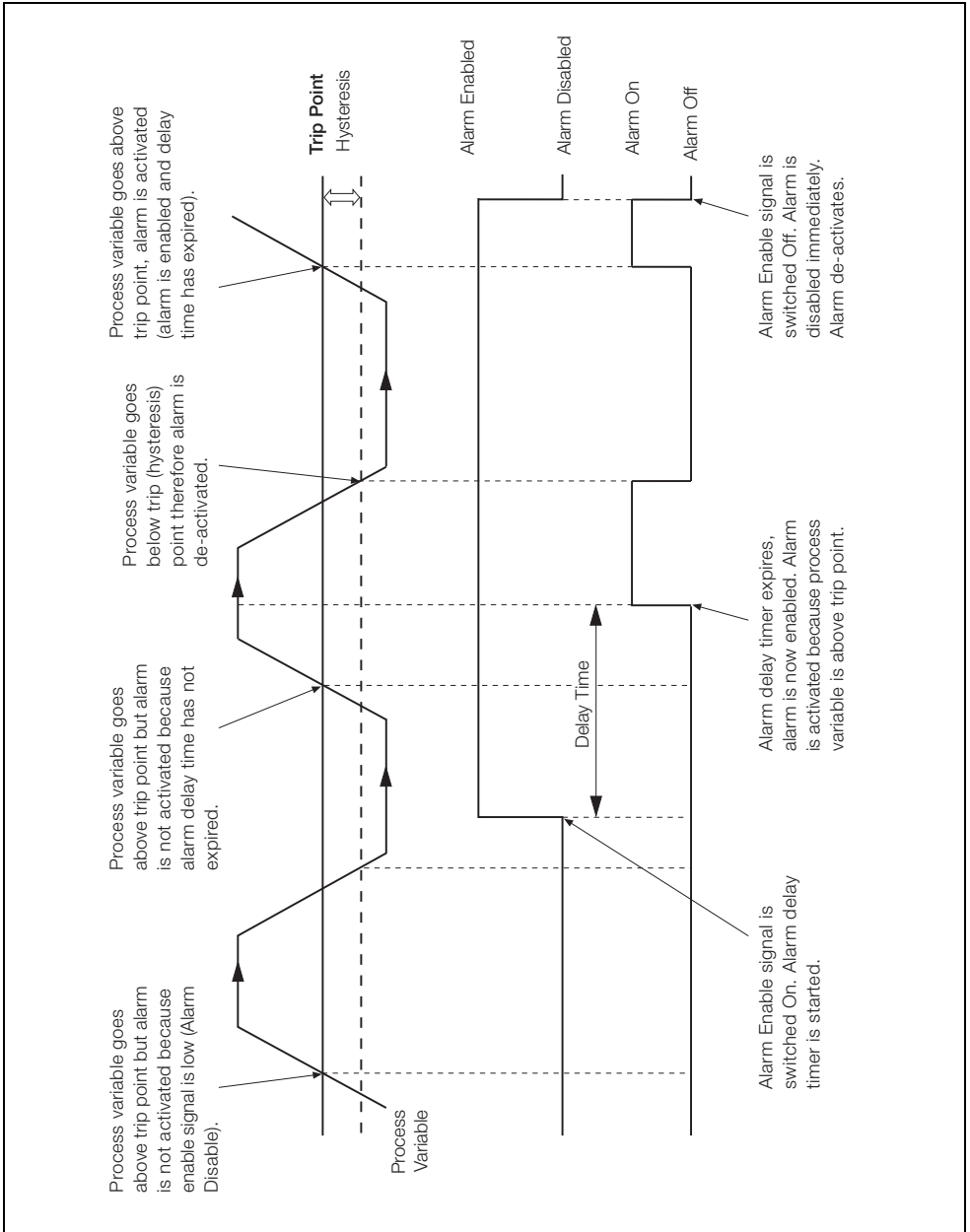
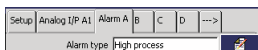

Fig. 7.15 Delayed High/Low Process Alarms

Note. The Alarm Configuration tabs are displayed only if 'Source ID' for the Recording Channel is set to an analog signal source – see Section 7.8.1, page 93.



Set the alarm type:

- High/Low process – see Fig. 7.11, page 100
- High/Low latch – see Fig. 7.12, page 100
- High/Low annunciate – see Fig. 7.13, page 101
- Fast/Slow rate – see Fig. 7.14, page 102
- Delayed high/low process – see Fig. 7.15, page 103



Enter an Alarm Tag to identify the alarm when it is displayed in the Chart, Process and Alarm Event views (20 characters max.).



Note. Process and Latch alarms only – see Figs 7.11 and 7.12, page 100.

Set the value, in engineering units, at which the alarm is to activate.



Set the hysteresis value in engineering units and the time hysteresis in seconds.

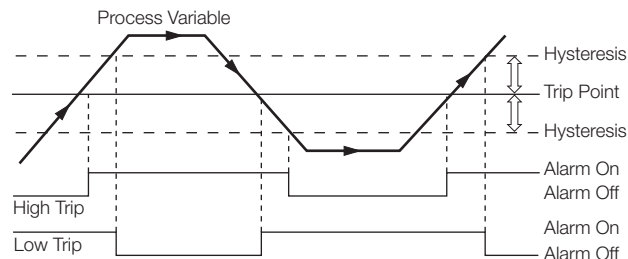
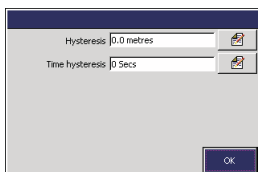

When an alarm trip value is exceeded, the alarm does not become active until the time hysteresis value has expired. If the signal goes out of the alarm condition before the time hysteresis has expired, the hysteresis value is reset.



Note. Annunciate alarms only – see Fig. 7.13, page 101.

Set the value, in engineering units, at which the alarm is to activate.

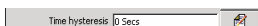

Set the time hysteresis in seconds.

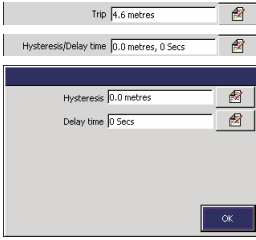

Note. Delayed process alarms only – see Fig. 7.15, page 103.

Set the value, in engineering units, at which the alarm is to activate.

Set the hysteresis value in engineering units and the delay time in seconds.

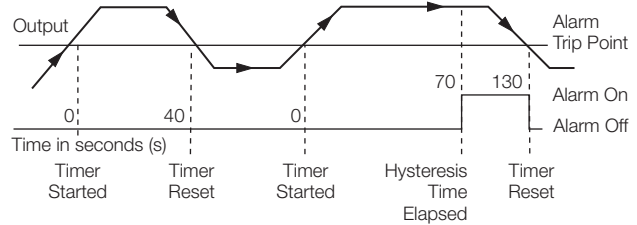

The delay time is the period of time for which alarm activation is delayed after the enable signal is switched on. Once the delay time has expired, the alarm operates in the same way as a standard High/Low process alarm.

Note.

- Rate alarms only – see Fig. 7.14, page 102.
- A Rate alarm remains active until the rate has been within limits for at least one complete Alarm Period.

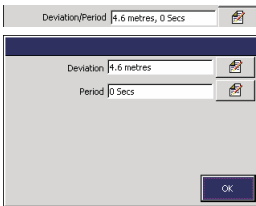

Set the minimum or maximum amount of deviation allowed within the Rate Alarm Period before the alarm is activated.

Set the time period over which the deviation is measured. For High Rate alarms, the alarm becomes active if the value changes by more than the deviation value within the alarm period. For Low Rate alarms, the alarm becomes active if the channel value changes by less than the deviation within the alarm period.

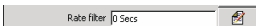

Set the filter time to be used to reduce the number of spurious alarm trips. The source signal is averaged over the filter period prior to the rate alarm being determined.

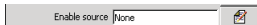

Select an alarm enable source. When the 'Enable source' is active, the alarm is enabled. When the source is inactive the alarm is disabled. If set to 'None' the alarm is always enabled.

Note. For Delayed Process alarm operation, see Fig. 7.15, page 103.

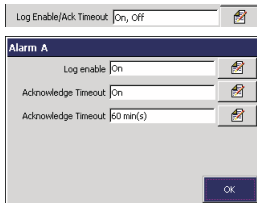

Set 'Log enable' to 'On' to record all changes in the alarm state in the Alarm event log – see Section 4.7, page 43.

Set 'Acknowledge Timeout' to 'On' to enable an alarm acknowledgement timeout period that can then be set to between 1 and 999 minutes.

If the alarm is acknowledged but the alarm condition is not cleared within the time-out period, the acknowledge state is set back to 'active/unacknowledged'.

Note. The 'Acknowledge Timeout' function is designed to prevent an alarm from being acknowledged but the reason for the occurrence being ignored.

Example. An application has a vital requirement for a product to be kept below a certain temperature (the alarm setpoint) and the recorder's alarm relay is connected to an external audible warning device. If the temperature exceeds the alarm setpoint, the alarm is activated, triggering the audible warning. To preserve accountability, the alarm can be acknowledged only by an operator with alarm acknowledgement privileges (see Section 7.6.5, page 80) and if acknowledged, the audible warning is silenced. If the temperature does not drop below the alarm setpoint before the time-out period expires, the alarm state is reset to active/unacknowledged and the audible warning sounds again.

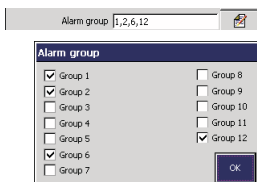

Assign the alarm to one or more of 12 groups.

The alarm states assigned to each group are 'ORed' together to create an internal digital signal that may be assigned to relays, digital outputs or internal digital controls.

7.8.5 Totalizer Configuration

Note.

- The totalizer tabs are displayed only if the Totalizer option is enabled.
- Current totalizer values are displayed in the Indicator view – see Section 4.5, page 38 (Operation) and Section 7.7.3, page 89 (Configuration) respectively.
- For analog sources, the total value of a signal is calculated by counting pulses produced at a rate proportional to the input. For digital sources, off/on transitions are counted to produce a batch total.

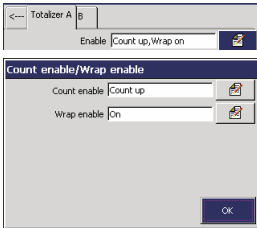

Select the totalizer Count direction and Wrap action.

When the count direction is set to 'Up', the totalizer counts up from the 'Preset count' value to the 'Predetermined count' value – see next page.

If 'Wrap enable' is set to 'On', the total is reset automatically to the 'Preset count' value once the 'Predetermined count' value is reached.

If 'Wrap enable' is set to 'Off', the count stops when the 'Predetermined count' value is reached.

Note. A wrap pulse, with a duration of 2s, occurs if the total reaches the 'Predetermined count' value and 'Wrap enable' is set to 'On'. If 'Wrap enable' is set to 'Off', the wrap pulse becomes active when the 'Predetermined count' value is reached and remains active until the totalizer is reset. The pulse can be assigned to a relay, digital output or digital counter.



Enter the totalizer tag to be displayed in the Indicator view and the Totalizer log archive (5 characters max).



Select any of the totalizer units pre-programmed into the recorder or select 'Custom' and enter user-defined units (6 characters max.). Refer to Appendix D, Table D.2, page 164 for a description of the pre-defined totalizer units.

Note. The recorder can be configured to calculate the totalizer count rate automatically by ensuring that the engineering range unit of measurement selected for the channel to which the totalizer is assigned is a volumetric unit (i.e. quantity per unit of time, for example, gallons per hour) – see page 97. If the recorder holds the relationship data between the measurement units and the totalizer units selected, the count rate parameter (see below) is calculated and displayed automatically.



Select the totalizer action following a power failure and a digital signal to stop and start the totalizer:

Stop/Go recovery

- Last – On power recovery, the totalizer continues in the same state as before the failure, i.e. stopped or running.
- Stop – Totalizer stops counting.
- Go – Totalizer starts counting from the last recorded value.

Stop/Go source

Select a signal source to stop and start the totalizer; refer to Appendix A, page 146 for a description of the available sources.

Note. This signal is edge-triggered. A rising edge (inactive to active) starts the totalizer. A falling edge (active to inactive) stops the totalizer.



Select a 'Reset source' signal (see Appendix A, page 146) – an edge-triggered signal to reset the totalizer on a rising edge.

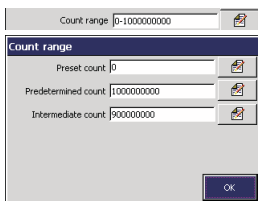

Set the 'Preset count' value – the value the totalizer counts from and the value applied when the totalizer is reset.

Set the 'Predetermined count' value – the value at which the totalizer stops or wraps.

Note.

- A counter configured to count up must have a 'Preset count' value lower than the 'Predetermined count' value. A counter configured to count down must have a 'Preset count' value greater than the 'Predetermined count' value.
- Set the required number of decimal places on the higher of the 'Preset count' value or 'Predetermined count' value.

Set the 'Intermediate count' value – the value at which a digital source is activated. This can be used as an alarm threshold to indicate when the 'Predetermined count' value is about to be reached.

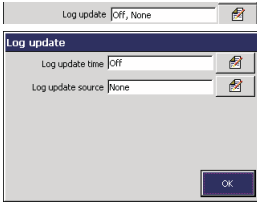

Select the frequency with which totalizer values are added to the Totalizer log.

Select a 'Log update source' signal (see Appendix A, page 146) – an edge-triggered signal to trigger the addition of the current totalizer values to the Totalizer log on a rising edge.

Log update time	Log updated every...
5 minutes	0, 5, 10, 15... etc. minutes past the hour
10 minutes	0, 10, 20, 30,...etc. minutes past the hour
15 minutes	0, 15, 30, 45 minutes past the hour
20 minutes	0, 20, 40 minutes past the hour
30 minutes	0, 30 minutes past the hour
60 minutes	On the hour
2 hours	Midnight, 2am, 4am, etc.
3 hours	Midnight, 3am, 6am, etc.
4 hours	Midnight, 4am, 8am, etc.
8 hours	Midnight, 8am, 4pm, etc.
12 hours	Midnight, 12am
24 hours	Midnight

Note.

- Analog totalizers only.
- If the recorder holds the relationship data between the selected engineering range unit of measurement (see page 97) and the selected totalizer units (see page 107), the totalizer count rate is calculated and displayed automatically.

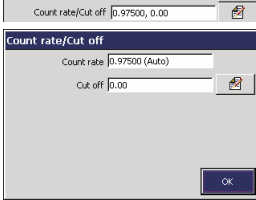

Set the required totalizer count rate (if necessary) and cut off value.

The count rate is determined by the maximum number of engineering units (or pulses) per second and the smallest totalizer increment:

$$\frac{\text{engineering full scale value (rate)}}{\text{engineering units (in seconds)}}$$

Example – to totalize a flow with a maximum rate of 2500 liters/minute (= 2.5m³/minute) to the nearest 0.1m³, the calculation is as follows:

$$\frac{150\text{m}^3/\text{hour}}{3600 \text{ seconds}} = 0.04167 \text{ pulses/second}$$

The resulting value must be within the range 0.00001 to 99.99999. The totalizer increment is determined by the number of decimal places in the 'Predetermined count' value – see page 108.

The totalizer cut off value is the lowest input value (in engineering units) at which the totalizer is to stop counting.

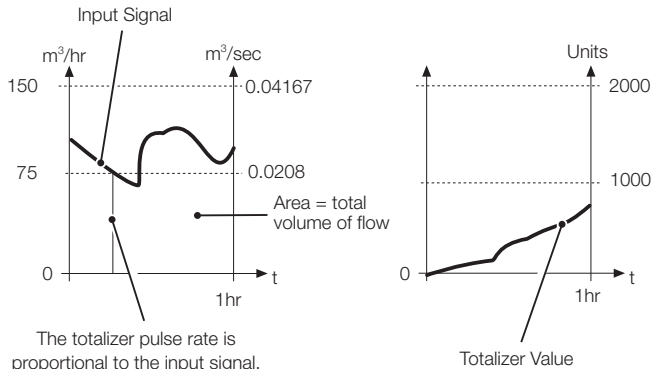

The totalizer pulse rate is proportional to the input signal. At this point it is 0.0208 pulses per second

OR



Note. Digital totalizers only.

Set the required totalizer count rate.

A digital totalizer pulse can be scaled to represent a value of between 0.00001 and 1000.00000. The totalizer is then incremented by this amount each time there is an off/on transition.

Example – a count of 5 digital pulses with 'Count rate' set to 100 increments the totalizer from 0 to 500 in 100 unit steps.

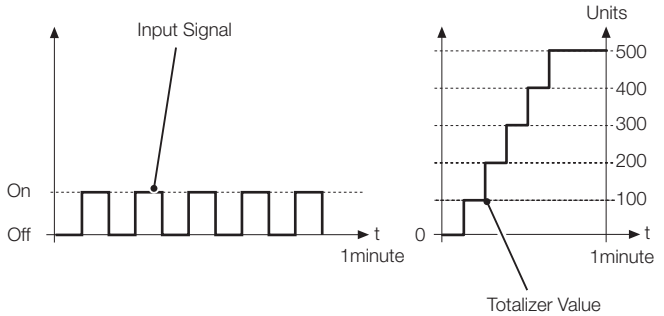

7.8.6 F0 (Sterilization Optimization) Configuration

Note.

- The totalizer tabs are displayed only if the Totalizer option is enabled.
- Current F0 values are displayed in the Indicator view – see Section 4.5, page 38 (Operation) and Section 7.7.3, page 89 (Configuration) respectively.
- Only Totalizer A on all recording channels can be configured to display an F0 value. If Totalizer A is configured to display an F0 value, Totalizer B on the same channel is disabled automatically.

Calculation

The recorder's F0 standard sterilization calculation is based on Ft @ T of 121.1 °C and Z of 10 °C where Ft = equivalent sterilization time of the sterilization procedure under temperature (T) conditions with a given Z value.

The recorder also adjusts Ft to compensate for changes in temperature in order to achieve a constant sterilization affect. The value used is D; a time value with a default setting of 1 minute.

The F0 algorithm used by the recorder is:

$$F_0 = (\text{SampleTime} \times (10^{((T - 121.11)/Z)})) / (60 + F_0^{\text{previous}})$$

The result of the F0 calculation is displayed in minutes in the Digital Indicator view (see Fig. 4.5, page 38) and in the totalizer log (see Fig. 4.8, page 45).

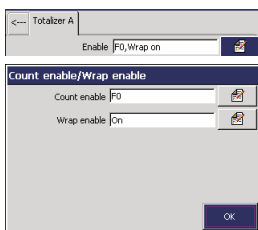

Set 'Count enable' to 'F0'.

If 'Wrap enable' is set to 'On', the total is reset automatically to the 'Preset count' value once the 'Predetermined count' value is reached.

If 'Wrap enable' is set to 'Off', the count stops when the 'Predetermined count' value is reached.

Note. A wrap pulse, with a duration of 2s, occurs if the total reaches the 'Predetermined count' value and 'Wrap enable' is set to 'On'. If 'Wrap enable' is set to 'Off', the wrap pulse becomes active when the 'Predetermined count' value is reached and remains active until the F0 value is reset. The pulse can be assigned to a relay, digital output or digital counter.



Enter the F0 tag to be displayed in the Indicator view and the Totalizer log archive (6 characters max).

Note. The default tag text includes 'F0' to distinguish an F0 value in the totalizer log but this can be changed.



Select the action following a power failure and a digital signal to stop and start the F0 value calculation:

Stop/Go recovery

- Last – On power recovery, the F0 value calculation continues in the same state as before the failure, i.e. stopped or running.
- Stop – F0 value calculation stops.
- Go – F0 value calculation continues from the last recorded value.

Stop/Go source

Select a signal source to stop and start the F0 value calculation; refer to Appendix A, page 146 for a description of the available sources.

Note. This signal is edge-triggered. A rising edge (inactive to active) starts the calculation. A falling edge (active to inactive) stops the calculation.

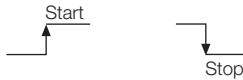

Select a 'Reset source' signal (see Appendix A, page 146) – an edge-triggered signal to reset the calculation on a rising edge.

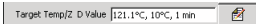

Default values for the target temperature, Z factor and time (D) value are entered but can be changed.

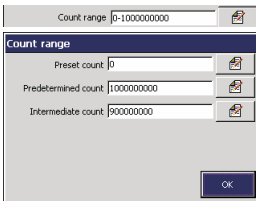

Set the 'Preset count' value – the value the F0 value calculation counts from and the value applied when the F0 count is reset.

Set the 'Predetermined count' value – the value at which the F0 count stops or wraps.

Note.

- The 'Preset count' value must be lower than the 'Predetermined count' value.
- Set the required number of decimal places on the 'Predetermined count' value.

Set the 'Intermediate count' value – the value at which a digital source is activated. This can be used as an alarm threshold to indicate when the 'Predetermined count' value is about to be reached.

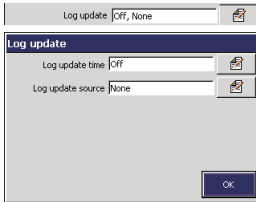

Select the frequency with which F0 values are added to the Totalizer log.

Select a 'Log update source' signal (see Appendix A, page 146) – an edge-triggered signal to trigger the addition of the current F0 values to the Totalizer log on a rising edge.

Log update time	Log updated every...
5, 10, 15, 30, 60, 90 seconds	
3 minutes	0, 3, 6, 9... etc. minutes past the hour
5 minutes	0, 5, 10, 15... etc. minutes past the hour
10 minutes	0, 10, 20, 30,...etc. minutes past the hour
15 minutes	0, 15, 30, 45 minutes past the hour
20 minutes	0, 20, 40 minutes past the hour
30 minutes	0, 30 minutes past the hour
60 minutes	On the hour
2 hours	Midnight, 2am, 4am, etc.
3 hours	Midnight, 3am, 6am, etc.
4 hours	Midnight, 4am, 8am, etc.
8 hours	Midnight, 8am, 4pm, etc.
12 hours	Midnight, 12am
24 hours	Midnight



Set the required F0 cut off value.

The cut off value is the minimum temperature value (T) used in the F0 value calculation. Temperatures read below this value are ignored.

7.9 Functions

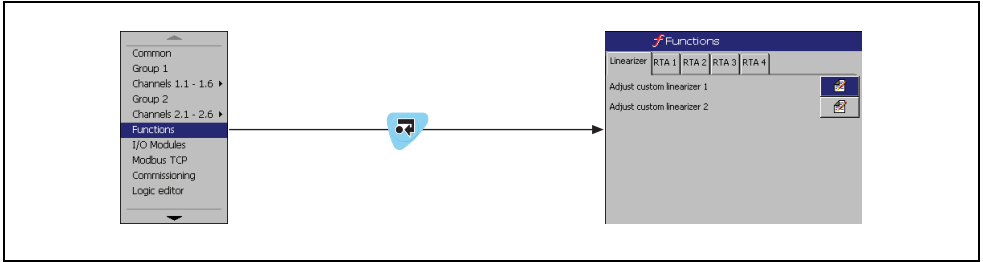
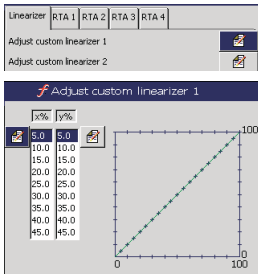

Fig. 7.16 Functions Configuration

7.9.1 Custom Linearizers



Use the ▲ and ▼ keys to highlight the linearizer to be adjusted.
 Press the ⏏ key to open the 'Adjust custom linearizer' screen.
 Use the ◀, ▶, ▲ and ▼ keys to highlight the point to be modified.
 Press the ⏏ key to open the digipad to change the position of that point.
 Press the ⏏ key to return to the Functions screen.
 Each linearizer has 20 breakpoints. Both X and Y values are set as percentages.

Custom linearizers can be applied to any analog input by selecting them as the linearizer type for that input – see 'Linearizer Type', page 96.

Note.

- X is input to the linearizer expressed as a percentage of the electrical range.
- Y is output expressed as a percentage of the engineering range.

7.9.2 Real-time Alarms

Linearizer	RTA 1	RTA 2	RTA 3	RTA 4
Alarm tag				Real Time Alarm 1

Enter the tag to be used in the Alarm Event log – see Section 4.7, page 43.

Daily enables

Select the day(s) on which the alarm is activated.

Daily enables

Sunday
 Monday
 Tuesday
 Wednesday
 Thursday
 Friday
 Saturday

OK

1st of the month enable

Set to 'On' to activate the real-time alarm on the first day of each month.

On time

Set the time at which the alarm becomes active.

On time

Every hour

Hours

Minutes

OK

If 'Every hour' is set to 'On', the 'Hours' setting cannot be adjusted and the alarm is activated at the same time every hour (determined by the 'Minutes' setting) or on the hour (if 'Minutes' is set to 'Off').

Duration

Set the duration for the alarm to remain active.

Log enable

Set to 'On' to add an entry to the Alarm event log each time the real-time alarm becomes active.

7.10 I/O Module Configuration

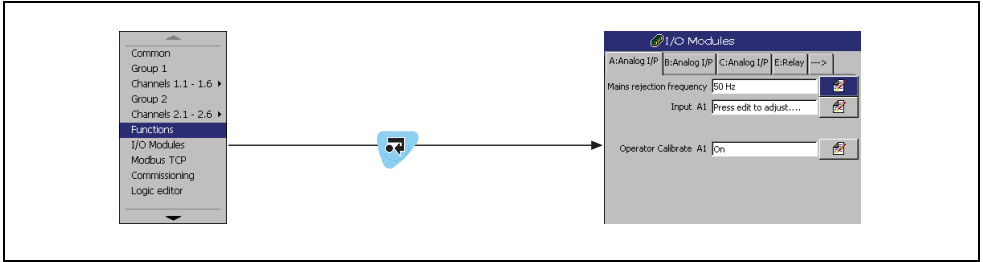
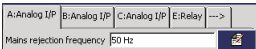

Fig. 7.17 I/O Module Configuration

Note. The recorder detects the type of module fitted in each position automatically.

7.10.1 Analog Inputs



Set the mains rejection frequency used to filter electrical noise induced on the signal lines by power supply cables.



Set to 'On' to enable input adjustment from Logging menu – see page 50.

Note. The following parameter is displayed only if recording is enabled during configuration, i.e. the 'Disable recording in configuration' check box is **not** ticked on entry to the Configuration level – see Fig. 7.1, page 66.

Input Adjustment

Manually fine-tune inputs to remove process offset errors or system scale errors.

Note.

- Changes to the Analog Input Type (see page 96) must be saved to the current configuration before commencing input adjustment.
- For dual input modules, 2 channels can be adjusted.

Actual value / Desired value

1. Adjust the process or simulated input signal to a known value below 50% of the engineering range.
2. If 'Actual value' (in engineering units) is different from expected, set 'Desired value' to the correct value ('Offset adjust' and 'Span adjust' values are calculated automatically).
3. Repeat steps 1 and 2 for a value above 50% of the engineering range.
4. Repeat steps 1 to 3 for each input.

Reset adjustment

Select to reset 'Offset adjust' and 'Span adjust' (below) to zero and to 1 respectively.

Offset adjust / Span adjust

Manually fine-tune the offset adjust and span adjust values to remove process errors. These are calculated values applied to the raw input signal.

Note. If simulating thermocouple inputs, connect the millivolt source using appropriate compensating cable – see Table 2.1, page 20. For 2-lead resistance thermometers, either connect the resistance box at the sensor end of the leads or add the lead resistance to the calibration values.

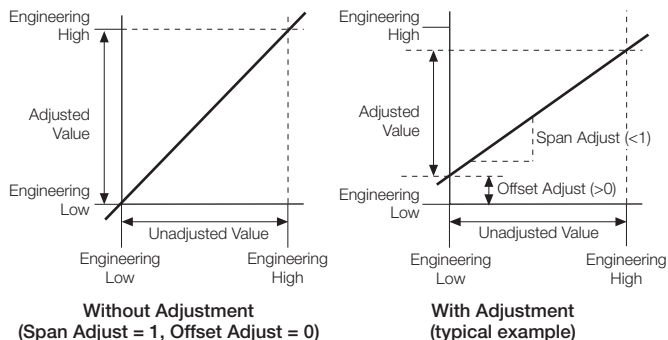

7.10.2 Relay Modules

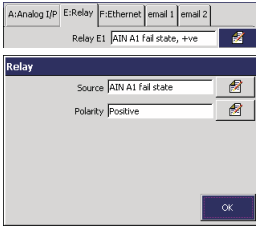

Select the relay source (a digital source) to be used to energize/de-energize the relay.

Note. If the relay is used to provide a totalizer count pulse, the maximum pulse frequency is 5Hz. Consideration must also be given to the mechanical life of the relay.

Select the relay source polarity.

Note. When polarity is set to 'Positive', the relay is energized when the digital source is active (On).

7.10.3 Ethernet Module

Note. This Section is applicable only if the optional Ethernet module is fitted.

The Ethernet module fitted to the recorder contains an embedded web server enabling the recorder's data and status to be viewed remotely using an internet browser on a PC. The web server supports up to eight independent connections.

Note. Changes to the IP address, subnet mask and default gateway are implemented only after the recorder has been restarted. Change the addressing parameters, exit and save the configuration, wait until the 'Please Wait' message disappears then power down and restart the recorder.

A:Analog IP	E:Relay	F:Ethernet	email 1	email 2
IP-address 10.44.211.49				

Enter the IP-address assigned to the recorder. The IP address is used by the TCP/IP protocol to distinguish between different devices. The address is a 32 bit value expressed with four values (0 to 255), each separated by a period (.).

Subnet mask	255.255.255.0
-------------	---------------

The subnet mask is used to indicate which part of the IP address is for the network ID and which is for the host ID. Set as 1s each bit that is part of the network ID, e.g. 255.255.255.0 indicates that the first 24 bits are for the network ID.

Default Gateway	10.44.211.1
-----------------	-------------

Set the IP address for the 'default gateway (router, switch etc.) required to communicate with other networks. This setting may not be required. The default setting is '0.0.0.0'.

FTP user 1

FTP user 1

User name

Password

Access Level: Readonly

Remote Operation: None

OK

The FTP User name and password are used during logon to enable the FTP server. Access for up to four different users is provided. These passwords can also be used to allow access to some functionality provided by the web server.

Enter a name and password for the user granted FTP access.

Select an FTP access level for the user:

- Full – user can read, write and delete files
- Read-only – user can read files only.

Select an access level for Remote Operation by the user:

- Configuration – user can change the time & date or load a new configuration into the recorder from a web browser. This is in addition to the operator functions.
- Operator – user can acknowledge alarms and start, stop and reset totalizers from a web browser.
- None – user cannot log on to the recorder from a web browser.

Note. If a user is given full access via FTP, that user is able to delete both data and configuration files. This could result in erroneous operation of the recorder.

7.10.4 E-Mail

Note. This Section is applicable only if the optional Ethernet module is fitted.

The recorder can be configured to send e-mails to a maximum of 6 recipients in response to certain events. The addressees can all subscribe to the same SMTP server or the recorder can be configured to send e-mails via 2 different SMTP servers to a maximum of 3 addressees per server.

Up to 10 independently configurable triggers can be enabled to generate an e-mail when the selected source becomes active.

When a trigger source becomes active, an internal 1 minute delay timer is started. At the end of that minute, an e-mail is generated that includes, not only the event that initiated the delay timer, but every other event that occurred during the delay period together with any enabled reports. The data returned in the e-mail therefore reflects the real-time alarm state at the time the e-mail was generated, not the state when the first trigger source became active.

Each e-mail includes a link to the recorder's embedded web server enabling the recorder's data and status to be viewed remotely using an internet browser on a PC.



SMTP Authentication

SMTP messages are sent without authentication, meaning they are sent without a name and password to identify the originator of the email. This may cause an email server to reject a recorder's request to send an email.

To prevent this, allocate a fixed IP address to the recorder and ensure this IP address is explicitly allowed as valid in the configuration of the email server (and any intervening firewalls).

A:Analog I/P	E:Relay	F:Ethernet: email 1	email 2
SMTP Server IP address		172.16.1.1	

Enter the IP address of the SMTP server through which e-mails are to be routed.

Recipient 1	<input type="text"/>	
Recipient 2	<input type="text"/>	
Recipient 3	<input type="text"/>	

Enter the address(es) of the e-mail recipient(s).

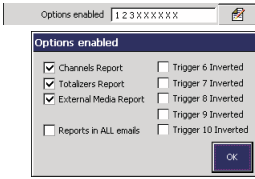

Select the options to enable.

Channels Report

When selected, a summary of all enabled channels together with their instantaneous values is included in the e-mail.

Totalizers Report

When selected, a summary of all enabled totalizers together with their instantaneous values is included in the e-mail.

External Media Report

When selected, a summary of the condition of the external media (if any) and archiving status is included in the e-mail.

Note.

- Reports, when enabled, are included only on an e-mail generated as a result of a real time alarm event unless the 'Reports in ALL emails' box is ticked, in which case enabled reports are included on every e-mail generated.
- Triggers 6 to 10, if enabled (see below), may be 'inverted', i.e. an e-mail is generated when the trigger source becomes inactive instead of active. Event trigger source types that cannot be inverted are: Alarm acknowledge, Any alarm and New alarm.



Select up to 10 event source types to generate an e-mail.

7.10.5 RS485 (Modbus™) Communications

Note. This Section is applicable only if the optional Modbus/Digital Input module is fitted.

Refer to Appendix B, page 148 for further information on using the Modbus link.

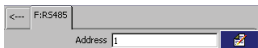
A screenshot of a configuration menu for 'F:RS485'. It shows a field labeled 'Address' with the value '1' and a blue arrow button to the right.

Set a unique Modbus Address (between 1 and 31) to enable the host system to identify the instrument on a Modbus link.

Note. Maximum 31 slaves per loop.

A screenshot of a configuration menu showing a field labeled 'Baud rate' with the value '19200' and a blue arrow button to the right.

Set to the Baud rate used by the host system: 1200, 2400, 4800, 9600, 19200, 38400, 115200.

A screenshot of a configuration menu showing a field labeled 'Parity' with the value 'None' and a blue arrow button to the right.

Set to the Parity used by the host system: None, Odd, Even.

7.11 Modbus TCP

Modbus TCP enables Modbus TCP devices to communicate via an ethernet network transferring Modbus messages via TCP/IP. Communication with standard, serially connected, Modbus RTU devices is also possible through a Modbus TCP Gateway.

The recorder can be configured to act as either a Modbus TCP Server (Slave) or a Modbus TCP Client (Master) device on a Modbus TCP network.

If configured as a Server, the recorder responds to Modbus queries transferred via the Modbus TCP protocol for the registers described in Appendix B, page 148. The recorder can be configured for unrestricted access or access can be restricted to a maximum of 6 Modbus TCP Clients, from defined IP addresses.

If configured as a Client, the recorder collects data from Modbus TCP Servers (or RTUs via a gateway) into its 24 Comms Analog and 24 Comms Digital Channels. Each analog and digital input can be individually configured to any register within any slave device. The configuration allows for receipt of data in most commonly used data formats



Select the required Modbus TCP configuration.

- Disabled – Modbus TCP disabled.
- Modbus TCP Server – recorder acts as a Modbus Slave
- Modbus TCP Client – recorder acts as a Modbus Master

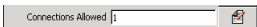

Note. Displayed only if 'Implementation' is **not** set to 'Disabled'.

Select the maximum number of simultaneous TCP/IP connections permitted – min. 1, max. 9.



Note. Displayed only if 'Implementation' is **not** set to 'Disabled'.

Set the TCP/IP port-through used by the Modbus TCP network – normally port 502.

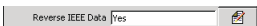

Note. Displayed only if 'Implementation' is set to 'Modbus TCP Server'.

All analog data is read from the recorder in IEEE format contained in adjacent registers representing the data in high word, low word order.

Select 'Yes' to reverse the IEEE data, otherwise select 'No'.

Note. The following parameters are displayed only if 'Implementation' (see page 125) is set to 'Modbus TCP Client'.

Poll Rate (ms) 1000 

Set the poll rate in milliseconds – min. 0, max. 3600000.

Poll fail limit 1 

Set the number of successive polls permitted to fail before the data is marked as a failed input – min. 0, max. 4.

Response Timeout (ms) 1000 

Set the timeout time in milliseconds for a single poll – min. 0, max. 60000.

Note. If any RTU devices connected through a gateway are polled, set a response time that is long enough to allow for the normal turn around time from these devices. The configuration allows for only one setting for all devices connected to the network.

7.11.1 Client Authorization







Note. This tab is displayed only if only if 'Implementation' on the 'Modbus TCP' tab is set to 'Modbus TCP Server' or 'Disabled' – see page 125.

Modbus TCP Client Authorization

TCP Client Access 6 

Select the maximum number of simultaneous TCP/IP connections permitted:

- Unrestricted – any Modbus TCP Client device is permitted to poll the recorder.
- 1 (to 6) – only the Modbus TCP client device(s) whose IP address(es) is(are) entered in the 'Authorized IP 1' (to 'Authorized IP 6') parameter(s) (below) is(are) permitted to poll the recorder.

Authorized IP 1	0.0.0.0	
Authorized IP 2	0.0.0.0	
Authorized IP 3	0.0.0.0	
Authorized IP 4	0.0.0.0	
Authorized IP 5	0.0.0.0	
Authorized IP 6	0.0.0.0	

Note. Displayed only if 'TCP Client Access' is not set to 'Unrestricted'.

Enter the IP address(es) of the Modbus TCP Client (Modbus Master) device(s) that is(are) permitted to poll the recorder for data.

7.11.2 Comms Analog Input

Note. This tab is displayed only if only if 'Implementation' on the 'Modbus TCP' tab is set to 'Modbus TCP Client' – see page 125.



Select the comms analog input to hold the data from the nominated slave device.

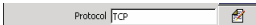

Select the communications protocol to be used by the recorder to communicate with a nominated slave device:

- None – comms analog channel unused
- TCP – Modbus Transmission Control Protocol
- RTU – access a Remote Terminal Unit (RTU) via Modbus TCP gateway

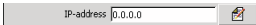

Note. Displayed only if 'Protocol' is set to 'TCP'.
Enter the IP address assigned to the slave device.

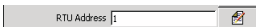

Note. Displayed only if 'Protocol' is set to 'RTU'.
Enter the RTU address assigned to the remote unit (1 to 247).

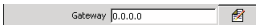

Note. Displayed only if 'Protocol' is set to 'RTU'.
Set the IP address for the Modbus TCP gateway for connection to the RTU.



Note. Displayed only if 'Protocol' is set to 'TCP' or 'RTU'.
Enter the register number to be read in the slave device.

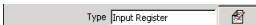

Note. Displayed only if 'Protocol' is set to 'TCP' or 'RTU'.
Select the register type, 'Holding Register' or 'Input Register'.

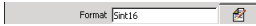

Note. Displayed only if 'Protocol' is set to 'TCP' or 'RTU'.

Select the format of the data to be read from the slave device:

- Sint16 – signed, 16 bit integer
- Sint32 – signed, 32 bit integer, transmitted in high/low order
- rev. Sint32 – signed, 32 bit integer, transmitted in low/high order
- IEEE – 32 bit floating point number, transmitted in high/low order
- Rev. IEEE – 32 bit floating point number, transmitted in low/high order

7.11.3 Comms Digital Input

Note. This tab is displayed only if only if 'Implementation' on the 'Modbus TCP' tab is set to 'Modbus TCP Client' – see page 125.

Modbus TCP	Comms analog I/P	Comms digital I/P
Comms digital I/P		Comms Dig I/P 1

Select the comms digital input to hold the status from the nominated slave device.

Protocol TCP

Select the communications protocol to be used by the recorder to communicate with a nominated slave device:

- None – comms digital channel unused
- TCP – Modbus Transmission Control Protocol
- RTU – access a Remote Terminal Unit (RTU) via Modbus TCP gateway

IP-address 0.0.0.0

Note. Displayed only if 'Protocol' is set to 'TCP'.
Enter the IP address assigned to the slave device.

RTU Address 1

Note. Displayed only if 'Protocol' is set to 'RTU'.
Enter the RTU address assigned to the remote unit (1 to 247).

Gateway 0.0.0.0

Note.

- Displayed only if 'Protocol' is set to 'RTU'.
- This setting is always required to access a RTU via Ethernet.

Set the IP address for the Modbus TCP gateway required to communicate with the RTU.

Register Number 0

Note. Displayed only if 'Protocol' is set to 'TCP' or 'RTU'.
Enter the register number to be read or written to in the slave device.

Type Input Status

Note. Displayed only if 'Protocol' is set to 'TCP' or 'RTU'.
Select the register type, 'Input Status' or 'Coil Status'.

7.12 Logic Editor

Note. The logic equation editor tabs are displayed only if the Math/Logic option is enabled.



Select the logic equation to create or modify.



Specify the first operand – can be any digital signal.

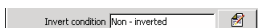

Invert the signal, if required.



Select an operator for the next input – see Table 7.5.

Inputs	A	0	0	1	1
	B	0	1	0	0
	Operators	Outputs			
All inputs high	AND	0	0	1	1
Any (or All) input(s) low	NAND	1	1	1	0
Any (or All) input(s) high	OR	0	1	1	1
No inputs high	NOR	1	0	0	0
Any, but not All, input(s) high	XOR	0	1	1	0

Table 7.5 Logic Operators

Repeat these steps until the equation is complete.

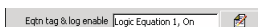

Enter an equation tag (20 characters maximum) to be displayed in the Alarm Event log.

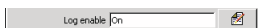
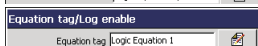

Set to 'On' to enable changes in the equation's state to be recorded in the Alarm Event log.

7.13 Math Equations

Note.

- The math equations tabs are displayed only if the Math/Logic option is enabled.
- Up to eight math equations can be configured individually using the 'Math Pad' – see Fig. 7.18.
- A Tag and an Engineering Range can be assigned to each math result.
- Up to 18 different preset functions can be used in math equations.
- Constants with up to three decimal places can be used in math equations.
- Each math equation can be up to 40 characters in length.
- Up to three digital signals can be assigned to each equation.
- For further information regarding math equations and functions, refer to Appendix E, page 165.

7.13.1 Using the Math Block Editor (Math Pad)

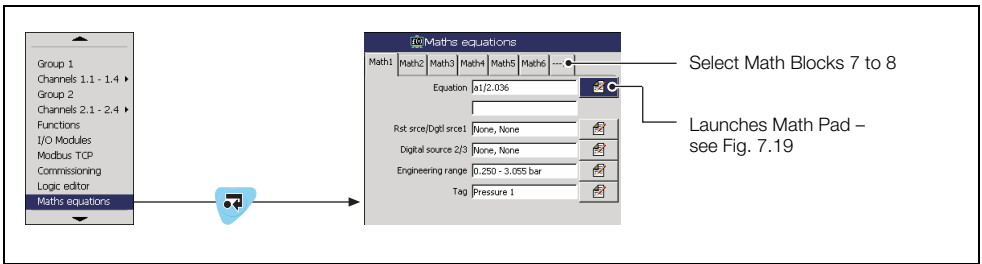

Fig. 7.18 Launching the Math Block Editor (Math Pad)

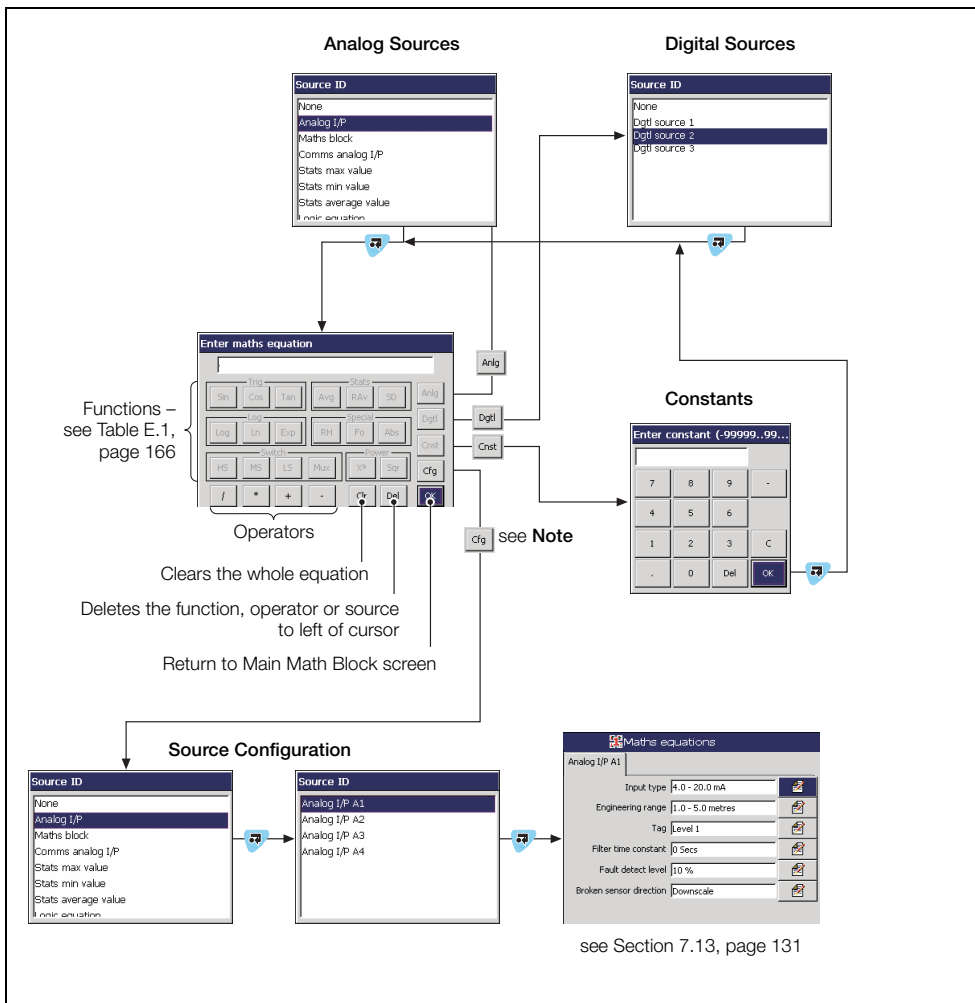

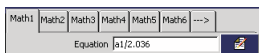

Fig. 7.19 Math Pad

Note. Use the  button to change the configuration of the selected channel source, without the need to exit the math block configuration sequence.

7.13.2 Math Block Configuration



Select the Math Block to create or modify – M1 to M8.

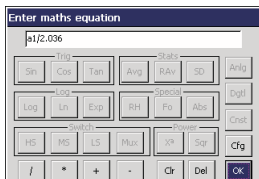

Set the equation using the math pad – see Fig. 7.19, page 132.

Note. Digital sources must first be assigned to a valid digital signal – see below.

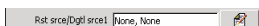

Reset Source / Digital Source 1

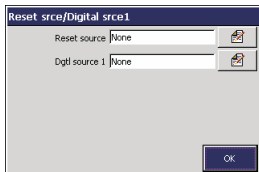

Set the digital source (e.g. alarm signal, real-time event) used to reset the equation.

Select the digital signal (e.g. alarm signal, real-time event) used as Digital Source 1 (md1) within the math block.

Note. When used in a Math Block, an active digital signal has a numerical value of 1 and an inactive digital signal has a value of 0.

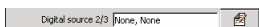

Select the digital sources (e.g. alarm signal, real-time event) used as Digital Source 2 and 3 (md2 and md3) within the equation.

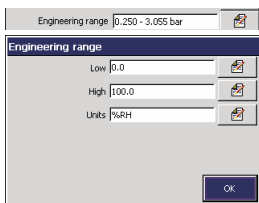

Specify the display range and units of the engineering value corresponding to the electrical high and low values, within the limits defined in Table 7.4, page 97.

Example – Maximum and minimum calculated values function:

$a1 + a2$, where $a1 \equiv 0$ to 150 l/s, $a2 \equiv -50$ to 100 l/s, Engineering High = 250.0, Engineering Low = -50.0.

Note. For the best resolution enter engineering ranges to the maximum permissible number of decimal places.



Enter the tag name to be displayed on channel indicators and used to identify the channel in archive files. (16 characters max.).

Note. Tags with a high percentage of capital letters and wide characters such as 'W' or 'M' may appear truncated in some Operator views. In such cases, use lower case letters or fewer characters.

8 Specification

Operation and Configuration

Configuration

Via tactile membrane keys on front panel or PC Configuration

Multiple configuration files can be stored in internal (up to 16 files) or external memory (with removable media option fitted)

Security

Physical

Optional lock on door

Configuration security

Password protection Access to configuration is allowed only after the user has entered a password

Internal switch protection Access to configuration is allowed only after a hardware switch has been set. This switch is situated behind a tamper-evident seal

Logging security

Configuration Can be configured for password protection or free access to logging levels

Basic type security

4 individual users with unique usernames and passwords

Advanced type security

Number of users Up to 12

Usernames Up to 20 characters. Usernames are unique (names cannot be repeated)

Access privileges Logging access – Yes/No
Configuration access
None/Load file only/Limited/Full

Passwords Up to 20 characters
A minimum required password length of 4 to 20 characters can be configured and a password expiry time can be applied to eliminate password ageing

Password failure limit Configurable for 1 to 10 consecutive occasions or 'infinite'
A user is deactivated if a wrong password is entered repeatedly

Deactivation of inactive users Can be disabled or configured for 7, 14, 30, 60, 90, 180 or 360 days of inactivity
Users are deactivated (by removal of access privileges) after a period of inactivity

Custom Linearization

Number

2

Number of breakpoints

20 per linearizer

Operator Messages

Number

24

Trigger

Via front panel or digital signals

Recording in alarm/event log

Can be enabled or disabled on configuration

Display

Monochrome FSTN or Color TFT, liquid crystal display (LCD) with built-in backlight and contrast adjustment

Diagonal display area color 144 mm (5.7 in.)
 monochrome 120 mm (4.7 in.)

76800 pixel display*

* A small percentage of the display pixels may be either constantly active or inactive. Max. percentage of inoperative pixels <0.01%.

Language

English, German, French, Italian, Spanish, Portuguese, Chinese and Dutch

Dedicated operator keys

- Group select/Left cursor
- View select/Right cursor
- Menu key
- Up/Increment key
- Down/Decrement key
- Enter key

Chart screen intervals

Selectable from 18 s to 7 days

Chart divisions

Programmable for up to 10 major and 10 minor divisions

Chart annotation

Alarm and operator messages may be annotated on the chart

Icons to identify the type of event, time of occurrence and tag are displayed

Process Alarms

Number

48 (4 per recording channel)

Types

High/Low process, latch & annunciator

Rate fast/slow

Tag

20-character tag for each alarm

Hysteresis

Programmable value and time hysteresis (1 to 9999 s)

Alarm enable

Allows alarm to be enabled/disabled via a digital input

Alarm log enable

Recording of alarm state changes in the alarm/event log can be enabled/disabled for each alarm

Acknowledgement

Via front panel keys or digital signals

Real-time Alarms

Number

4

Programmable

Day of the week, 1st of month, start and duration times

Recording to Internal Memory

Data Channels

Internal buffer memory

64 Mb Flash memory provides storage for 16 million samples

Oldest data is overwritten automatically by new data when memory is full

Data integrity checks

Checksum for each block of data samples

Independent process groups

2

No. of recording channels

6 per group

Sources

Analog inputs, MODBUS™ inputs, any digital signal, math block

Filters

Programmable for each channel to allow recording of: instantaneous values, average, max., min. and max. & min. value over sample time

Primary/Secondary sample rates

Programmable from 0.1 s to 12 hours for each process group

Primary/Secondary sample rate selection

Via any digital signal or from password protected menu

Recording start/stop control

Via any digital signal or from password-protected menu

Recording Duration

Approximate duration calculated for continuous recording of 4 channels of analog data (for 8 channels divide by 2, for 2 channels multiply by 2 etc.)

Sample Rate	1 s	10 s	40 s	60 s	120 s	480 s
64 Mb Internal Flash Buffer Memory	48 days	16 months	5 years	8 years	16 years	56 years

Archiving to Removable Media

Removable storage media options

- SD Card

Data that can be saved to removable media

- Recorded data for group 1 & 2 channels
- Alarm event log data
- Totalizer log data
- Audit log data
- Configuration
- Screen capture images

File structure

Configurable as either binary-encoded or comma-separated

Filename

20-character tag, prefixed with date/time

Data verification

Carried out automatically on all writes to removable-media files

Card Compatibility

ABB recorders comply with approved industry standards for memory cards and ABB fully tests any memory card they supply for compatibility with this device. Other cards not supplied by ABB may not be fully compatible with this device and therefore may not function correctly.

Card Size

Cards up to 2 Gb capacity may be used

Recording Duration

Approximate duration calculated for continuous recording of 4 channels of analog data
(for 8 channels divide by 2, for 2 channels multiply by 2 etc.)

Binary Encoded File

Sample Rate	1s	10s
128 Mb SD	3 months	2.5 years
256 Mb SD	6 months	5 years
512 Mb SD	12 months	10 years
1 Gb SD	2 years	20 years

Comma-separated File

Sample Rate	1s	10s
128 Mb SD	28 days	9 months
256 Mb SD	8 weeks	19 months
512 Mb SD	16 weeks	3 years
1 Gb SD	7 months	6 years

Historical Logs

Types

Alarm/Event, Totalizer and Audit logs

No. of records in each historical log

Up to 200 in internal memory

Oldest data is overwritten automatically by new data when log is full

Log Type Log Entry Events	Alarm/Event Log		Totalizer Log		Audit Log	
	Alarm state changes Operator messages		User-defined logging intervals Totalizer stop/start, reset, wrap Power up/down		Configuration/calibration changes System events Errors, operator actions	
	In Log	On Screen	In Log	On Screen	In Log	On Screen
Information Recorded in Log						
Date & time of event	✓	✓	✓	✓	✓	✓
Type of event	✓	✓	✓	✓	✓	✓
Tag	✓	✓	✓	✓	-	-
Source tag	✓	-	✓	-	-	-
Alarm trip value & units of measure	✓	-	-	-	-	-
Alarm state	✓	✓	-	-	-	-
Alarm acknowledgement state	✓	-	-	-	-	-
Operator ID	✓	-	-	-	✓	✓
Description	-	-	-	-	✓	✓
Batch total and units of measurement*	-	✓	✓	-	-	-
Max., min. and average values plus units*	-	✓	✓	-	-	-
Secure total	-	-	✓	-	-	-

* If Totalizer option is enabled and selected

Analog/Digital Inputs

General

Number of inputs

7 (1 as standard, up to 6 optional)

Input types

mA, mV, voltage, resistance, THC, 3-wire RTD, 4-wire RTD, volt-free digital, 24 V DC digital*

Thermocouple types

B, E, J, K, L, N, R, S, T

Resistance thermometer

PT100

Other linearizations

\sqrt{x} , $x^{3/2}$, $x^{2/2}$, custom linearization

Digital filter

Programmable 0 to 60s

Display range

-99999 to +999999

Common mode noise rejection

>120 dB at 50/60 Hz with 300 Ω imbalance resistance

Normal (series) mode noise rejection

>60 dB at 50/60 Hz

CJC rejection ratio

0.05 $^{\circ}\text{C}/^{\circ}\text{C}$

Sensor break protection

Programmable as upscale or downscale

Temperature stability

0.02 $\%/^{\circ}\text{C}$ or 2 $\mu\text{V}/^{\circ}\text{C}$

Long term drift

<0.2 % of reading or 20 μV annually

Input impedance

>10 $\text{M}\Omega$ (millivolts inputs)

>10 $\text{M}\Omega$ (voltage inputs)

44 Ω (mA inputs)

Analog/Digital resolution

16 bit

Standard Analog Input Modules/Analog/

Linear Inputs	Standard Analog Input	Accuracy (% of reading)
Millivolts	0 to 150 mV	0.1 % or $\pm 20 \mu\text{V}$
Milliamps	0 to 50 mA	0.2 % or $\pm 4 \mu\text{A}$
Volts	0 to 25 V	0.2 % or $\pm 1 \text{ mV}$
Resistance Ω (low)*	0 to 550 Ω	0.1 % or $\pm 0.1 \Omega$
Resistance Ω (high)*	0 to 10 k Ω	0.1 % or $\pm 0.5 \Omega$
Digital Input Specification	Switching threshold 4 V — Min. pulse width of On or Off state 200 ms	
Sample Interval	Universal Input Module – 100 ms per sample Dual (Process Input) Module – 200 ms per sample	
Input Isolation	Universal Input Module – 500 V DC channel-to-channel Dual (Process Input) Module – None	
Isolation from Rest of Instrument	Galvanically isolated to 500 V DC	

* Resistance/RTD not available on Dual (Process Input) module.

Analog Input Types

Thermocouple	Maximum Range °C	Maximum Range °F	Accuracy (% of reading)
B	-18 to 1800	0 to 3270	0.1 % or $\pm 2 \text{ }^\circ\text{C}$ (3.6 $^\circ\text{F}$) (above 200 $^\circ\text{C}$ [392 $^\circ\text{F}$]) *
E	-100 to 900	-140 to 1650	0.1 % or $\pm 0.5 \text{ }^\circ\text{C}$ (0.9 $^\circ\text{F}$)
J	-100 to 900	-140 to 1650	0.1 % or $\pm 0.5 \text{ }^\circ\text{C}$ (0.9 $^\circ\text{F}$)
K	-100 to 1300	-140 to 2350	0.1 % or $\pm 0.5 \text{ }^\circ\text{C}$ (0.9 $^\circ\text{F}$)
L	-100 to 900	-140 to 1650	0.1 % or $\pm 1.5 \text{ }^\circ\text{C}$ (2.7 $^\circ\text{F}$)
N	-200 to 1300	-325 to 2350	0.1 % or $\pm 0.5 \text{ }^\circ\text{C}$ (0.9 $^\circ\text{F}$)
R	-18 to 1700	0 to 3000	0.1 % or $\pm 1 \text{ }^\circ\text{C}$ (1.8 $^\circ\text{F}$) (above 300 $^\circ\text{C}$ [540 $^\circ\text{F}$]) *
S	-18 to 1700	0 to 3000	0.1 % or $\pm 1 \text{ }^\circ\text{C}$ (1.8 $^\circ\text{F}$) (above 200 $^\circ\text{C}$ [392 $^\circ\text{F}$]) *
T	-250 to 300	-400 to 550	0.1 % or $\pm 0.5 \text{ }^\circ\text{C}$ (0.9 $^\circ\text{F}$) (above -150 $^\circ\text{C}$ [-238 $^\circ\text{F}$]) *

* For B, R, S and T thermocouples, accuracy is not guaranteed below the value stated.

RTD	Maximum Range °C	Maximum Range °F	Accuracy (% of reading)
PT100	-200 to 600	-325 to 1100	0.1 % or $\pm 0.5 \text{ }^\circ\text{C}$ (0.9 $^\circ\text{F}$)

Relays

Number of relays

1 as standard, 2 optional, (1 Module)*

* When using dual relay option boards, high voltages above 120 V AC must not be connected alongside low voltage DC supplies.

Type and rating

Relay type	Selectable NO/NC	
Voltage	250 V AC	30 V DC
Current	5 A AC	5 A DC
Loading (non-inductive)	1250 VA	150 W

For dual relay boards, only the following permutations are permitted.

30 V DC / 30 V DC
 120 V AC / 30 V DC
 120 V AC / 120 V AC
 240 V AC / 240 V AC
 240 V AC / 120 V AC

AC supplies must be on the same phase.

2-Wire Transmitter Power Supply (optional)

Number

2 isolated supplies

Voltage

24 V DC nominal

Drive

22 mA (each supply)

Ethernet Module (optional)

Physical medium

10BaseT

Protocols

TCP/IP, FTP (server), HTTP, SMTP, Modbus TCP (Client + Server)

FTP server functions

Directory selection & listing

File upload/download

4 independently configurable users with full or read-only access

Web server functions

Operator screen monitoring/selection. Remote monitoring of recording channels, analog/digital signals, alarms, totalizers and archiving

SMTP client compatibility

Compatible with MS Exchange versions up to and including MS Exchange 2003

Modbus/Digital Input Module (optional)**Modbus****Physical medium**

2-wire RS485

Protocol

RTU

Baud rates

1200, 2400, 4800, 9600, 88400, 115200

Parity

None, odd, even

Digital input**Number**

2

Digital input types

Volt-free/24 V (automatic)

Polarity

User-configurable

Totalizer (optional)**Number**

2 per recording channel, 10-digit totals

Type

Analog, digital, F0

Statistical calculations

Average, maximum, minimum (for analog signals)

Advanced Math (optional)**Type**

8 equations provide ability to perform general arithmetic calculations including F0, mass flow (of ideal gases), relative humidity and emissions calculations

Size

40-character equation

Functions+, -, /, log, Ln., Exp, X^n , $\sqrt{\quad}$, Sin, Cos, Tan, mean, rolling average, standard deviation, high/median/low select, multiplexer, absolute, relative humidity**Tags**

8- and 20-character tags for each block

Update rate

1 enabled Math block is updated every 100 ms

Logic Equations (optional)**Number**

8

Size

11 elements each

Functions

AND, OR, NAND, NOR, XOR, NOT

Tags

20-character tag for each equation

Update rate300 ms

EMC**Emissions & immunity**Meets requirements of IEC61326 for an Industrial Environment

Electrical**Supply ranges**100 V to 240 V AC \pm 10% (90 V min. to 264 V max.) or

105 V DC min. to 115 V DC max.

10 V to 36 V DC (optional)

Power consumption

10 W max. 15 VA max.

Power interruption protectionNo effect for interrupts of up to 20 ms

Safety**General safety**

EN61010-1

Overvoltage Class III on mains, Class II on inputs and outputs

Pollution category 2

CSA 61010-1

UL 61010-1

Isolation500 V DC to earth (ground)

Environmental

Operating temperature range

-10 to 50 °C (14 to 122 °F)

Operating humidity range

5 to 95 %RH (non-condensing)

Storage temperature range

-20 to 70 °C (-4 to 174 °F)

Enclosure sealing

IP66 and NEMA4X (the enclosure meets the requirements of the NEMA 4X hosedown test)

Vibration

Conforms to EN60068-2-6

Physical

Size

144 mm (5.7 in.) x 144 mm (5.7 in.) x 84 mm (3.3 in.)

Weight

1.0 kg (2.2 lb) approx. (unpacked)

Panel cutout

138 mm (5.43 in.) x 138 mm (5.43 in.) x 67 mm (2.7 in.) behind panel

Case material

Glass-filled polycarbonate

Operator keypad

Tactile membrane keys

No. of keys

6

Cable gland entries

4 x 22.2 mm (0.87 in.) o.d. entries for 1/2 in. NPT glands

DS/SM500F-EN Rev. AF

Appendix A – Signal Sources

Source Name	Description
Analog Sources	
Analog I/P A1 to D2	Analog input values (from Analog input module). Available only if an analog input module is fitted in the relevant position.
Comms AIN 1 to 24	Analog input values. Received via the Modbus serial communications link – see Table B.14, page 158.
Stats 1.1 to 1.6 max Stats 2.1 to 2.6 max	Maximum Statistics Input Value. Value since the totalizer on a given channel last wrap or reset. Available only if the totalizer option is enabled, only on analog channels and only if the relevant totalizer is enabled in the Configuration level.
Stats 1.1 to 1.6 min Stats 2.1 to 2.6 min	Minimum Statistics Input Value. Value since the totalizer on a given channel last wrap or reset. Available only if the totalizer option is enabled, only on analog channels and only if the relevant totalizer is enabled during configuration.
Stats 1.1 to 1.6 avg Stats 2.1 to 2.6 avg	Average Statistics Input Value. Value since the totalizer on a given channel last wrap or reset. Available only if the totalizer option is enabled, only on analog channels and only if the relevant totalizer is enabled during configuration.
Error States	
AIN A1 to D2 Fail State	Analog Input Failure. Active when the signal detected at the analog input is outside the 'Fault Detect Level' specified during configuration.
Comms AIN 1 to 6 Fail State	
Stats 1.1 to 1.6 fail Stats 2.1 to 2.6 fail	Totalizer Input Value Failure. Activated when the totalizer fails, cleared when the totalizer wraps or is reset. Available only if the totalizer option is enabled, only on analog channels and only if the relevant totalizer is enabled during configuration.
Archive media not present	Active when the removable archive media is not present.
Too many files on arc media	Active when there are approximately 300 files on the removable archive media.
Archive 100% full	Active when the removable archive media is 100% full
Archive 80% full	Active when the removable archive media is 80% full.
Arc media present	Active when the removable archive media is present.
Archive on-line	Active when archiving is in progress.

Table A.1 Signal Sources

Source Name	Description
Digital Input States	
Digital I/P A1 to D2 and Digital I/P F1 and F2	Digital Input States. Digital signals received from analog input modules fitted at module positions A to D (if input 'Type' is set to 'Volt free digital input' or 'DC Digital I/P' during configuration) and digital input module fitted at module position F. Available only if the module is fitted.
Comms Dig I/P 1 to 24	Digital Input States. Digital signals received via Modbus serial link – see Table B.14, page 158.
Alarm state 1.1A to 2.6D	Alarm States. Available only if the relevant alarm is enabled during configuration.
Alarm ack state 1.1A to 2.6D	Alarm Acknowledge States. Available only if the relevant alarm is enabled during configuration. Acknowledged alarm = 0; Unacknowledged alarm = 1. Process, Latch and Annunciator alarms only.
Alarm group 1 to 12	Alarm Groups. Available only if any alarms are enabled during configuration. Active only if any of the alarms assigned to a group are active.
Any Alarm	Available only if there is at least one alarm enabled during configuration. Active only if any of the enabled alarms are active.
New Alarm	Available only as a source for e-mail triggers. Causes an e-mail to be generated if any alarm becomes active.
Real time alarm 1 to 4	Real Time Alarm States. Available only if the relevant alarm is enabled during configuration.
Run state 1.1 to 2.6	Totalizer Run States. Active while totalizer is running. Available only if the relevant totalizer is enabled in the configuration level.
Wrap pulse 1.1 to 2.6	Totalizer Wrap Pulse. Available only if the totalizer option is enabled and the relevant totalizer is enabled during configuration. If 'Wrap Enable' set to 'On' – active for 1 second when the predetermined count has been reached. If 'Wrap Enable' set to 'Off' – active when the predetermined count is been reached and remains active until the totalizer is reset
1st Stage O/P 1.1 to 2.6	Totalizer First Stage Output (Intermediate Count). Active for 1 second when the intermediate count has been reached. Available only if the totalizer option is enabled and the relevant totalizer is enabled during configuration.
Count pulse 1.1 to 2.6	Totalizer Count Pulse. Active for 100ms each time the totalizer updates by one whole count. E.g. if two decimal places are set, a pulse is generated when the totalizer value increments from 0.99 to 1.00 or 1.99 to 2.00

Table A.1 Signal Sources (Continued)

Appendix B – Modbus TCP/Modbus 485

B.1 Introduction

The recorder can be configured to act as either a Modbus TCP client or server, or, when fitted with an optional Modbus/RS485 serial communications module, a Modbus RS485 (RTU) slave.

If configured as a client, the recorder collects data from Modbus TCP servers (or RTUs via a gateway) into its Comms Analog and Comms Digital Channels.

If configured as a server the recorder responds to Modbus queries transferred via the Modbus TCP or Modbus RS485 (RTU) protocol for the registers described in this appendix.

Note. The Modbus RS485 option provides the following facilities:

- Standard RS422/485 communications.
- Modbus RTU protocol – for master (host computer/plc) to slave.
- 500V DC isolation from external connections to the instrument.
- Two-wire communication.
- 1200, 2400, 4800, 9600, 19200, 38400, or 115200 baud transmission rate.
- Parity-checking – odd, even or none.

B.2 Modbus Commands Supported

The following Modbus commands are supported:

- 01 **Read Coil Status** – reads the on/off status of 16 consecutive digital states, starting at a specified address. The recorder returns zeros for points which do not contain defined data.
- 03 **Read Holding Registers** – reads 8 consecutive analog values, starting from a specified address. The recorder returns zeros for registers which do not contain defined data.
- 05 **Force Single Coil** – Sets the value of a single coil (digital signal) at the specified address. The data value must be FF00Hex to set the signal ON and zero to turn it OFF. The recorder returns an exception response if the register is not currently writable.
- 06 **Preset Single Register** – Sets the value of a single register (analog value) at the specified address. The recorder returns an exception response if the register is not currently writable. Limits defined in configuration are applied to the value before storage.
- 15 **Force Multiple Coils** – The recorder carries out updates that are valid and returns an exception response if any of the coils are not currently writable.
- 16 **Preset Multiple Registers** – The recorder carries out updates that are valid and generates an exception response if any of the registers are not currently writable.

B.3 Modbus Exception Responses

If the recorder detects one of the errors shown in Table B.1 while receiving a message from the host system, it replies with a response message consisting of the recorder's Modbus address, the function code, the error code and the error check fields.

Code	Name	Definition
01	Illegal Function	The message function received is not an allowable action
02	Illegal Data Address	The address reference in the data field is not an allowable address
03	Illegal Data Value	The value referenced in the data field is not allowable in the addressed slave
07	Negative Acknowledgement	Received message error
08	Memory Parity Error	Parity check indicates an error in one or more of the characters received

Table B.1 Modbus Exception Responses

Note.

- Negative numbers are represented in '2's complement' format, for example, 1000 = 03E8 (Hex), -1000 = FC18 (Hex).
- The instrument cannot accept a new message until the current message has been processed and a reply sent to the master (maximum response time 50ms).
- The instrument monitors the elapsed time between receipt of characters from the host. If the elapsed time between two characters is 3.5 character times, the slave assumes the second character received is the start of a new message.

B.4 Operating Mode Modbus Coils

Tables B.2 to B.10 detail the contents of each Modbus coil. Each coil is assigned a register that can have one of two values: 0000 and 0001.

Read Only: 0 = Input OK, 1 = Input Failed	
Analog Input	Modbus Coil
A1	0001
B1	0002
B2	0005
C1	0003
C2	0006
D1	0004
D2	0007

Table B.2 Analog Input Fail States

	Alarm Active/Inactive	Alarm Acknowledged
Read Access	0 = Alarm inactive 1 = Alarm active	0 = Acknowledged or inactive 1 = Active and unacknowledged
Write Access	None	0 = No effect 1 = Acknowledge
Alarm	Modbus Coil	Modbus Coil
1.1A	0051	0101
1.1B	0052	0102
1.1C	0053	0103
1.1D	0054	0104
1.2A	0055	0105
1.2B	0056	0106
1.2C	0057	0107
1.2D	0058	0108
1.3A	0059	0109
1.3B	0060	0110
1.3C	0061	0111
1.3D	0062	0112
1.4A	0063	0113
1.4B	0064	0114
1.4C	0065	0115
1.4D	0066	0116
1.5A	0083	0133
1.5B	0084	0134
1.5C	0085	0135
1.5D	0086	0136
1.6A	0087	0137
1.6B	0088	0138
1.6C	0089	0139
1.6D	0090	0140

	Alarm Active/Inactive	Alarm Acknowledged
Read Access	0 = Alarm inactive 1 = Alarm active	0 = Acknowledged or inactive 1 = Active and unacknowledged
Write Access	None	0 = No effect 1 = Acknowledge
Alarm	Modbus Coil	Modbus Coil
2.1A	0067	0117
2.1B	0068	0118
2.1C	0069	0119
2.1D	0070	0120
2.2A	0071	0121
2.2B	0072	0122
2.2C	0073	0123
2.2D	0074	0124
2.3A	0075	0125
2.3B	0076	0126
2.3C	0077	0127
2.3D	0078	0128
2.4A	0079	0129
2.4B	0080	0130
2.4C	0081	0131
2.4D	0082	0132
2.5A	0091	0141
2.5B	0092	0142
2.5C	0093	0143
2.5D	0094	0144
2.6A	0095	0145
2.6B	0096	0146
2.6C	0097	0147
2.6D	0098	0148

Table B.3 Alarm States

		Read: Always returns '0' Write: 1 = Activate
Title	Coil Number	
Operator Message 1	0151	
Operator Message 2	0152	
Operator Message 3	0153	
Operator Message 4	0154	
Operator Message 5	0155	
Operator Message 6	0156	
Operator Message 7	0157	
Operator Message 8	0158	
Operator Message 9	0159	
Operator Message 10	0160	
Operator Message 11	0161	
Operator Message 12	0162	

		Read: Always returns '0' Write: 1 = Activate
Title	Coil Number	
Operator Message 13	0163	
Operator Message 14	0164	
Operator Message 15	0165	
Operator Message 16	0166	
Operator Message 17	0167	
Operator Message 18	0168	
Operator Message 19	0169	
Operator Message 20	0170	
Operator Message 21	0171	
Operator Message 22	0172	
Operator Message 23	0173	
Operator Message 24	0174	
Reserved	0175 to 0180	

Table B.4 Operator Messages

Title	Coil Number	Read	Write
Assign to Group 1	0181	0 = Remote operator message not assigned to group	0 = Unassign remote operator message from group
Assign to Group 2	0182	1 = Remote operator message assigned to group	1 = Assign remote operator message to group
Activate Remote Operator Message	0183	Always reads as 0	0 = No effect 1 = Activate

Table B.5 Remote Operator Messages

Modbus Registers					
	Stop/Go	Reset	Wrap Pulse	1st Stage Pulse	Flowrate Failure
Read Access	0 = Stopped	0 = >1s*	0 = Inactive	0 = Inactive	0 = Inactive
	1 = Running	1 = <1s*	1 = Active	1 = Active	1 = Active
Write Access	0 = Stop 1 = Start	1 = Reset			
Totalizer	Modbus Coil	Modbus Coil	Modbus Coil	Modbus Coil	Modbus Coil
1.1A	0351	0401	0451	0501	0551
1.1B	0352	0402	0452	0502	0552
1.2A	0353	0403	0453	0503	0553
1.2B	0354	0404	0454	0504	0554
1.3A	0355	0405	0455	0505	0555
1.3B	0356	0406	0456	0506	0556
1.4A	0357	0407	0457	0507	0557
1.4B	0358	0408	0458	0508	0558
1.5A	0367	0417	0467	0517	0567
1.5B	0368	0418	0468	0518	0568
1.6A	0369	0419	0469	0519	0569
1.6B	0370	0420	0470	0520	0570
2.1A	0359	0409	0459	0509	0559
2.1B	0360	0410	0460	0510	0560
2.2A	0361	0411	0461	0511	0561
2.2B	0362	0412	0462	0512	0562
2.3A	0363	0413	0463	0513	0563
2.3B	0364	0414	0464	0514	0564
2.4A	0365	0415	0465	0515	0565
2.4B	0366	0416	0466	0516	0566
2.5A	0371	0421	0471	0521	0571
2.5B	0372	0422	0472	0522	0572
2.6A	0373	0423	0473	0523	0573
2.6B	0374	0424	0474	0524	0574

* Time since last reset

Table B.6 Totalizer Digital Signals

Read Only: 0 = All alarms inactive 1 = At least 1 alarm active	
Title	Coil Number
Any Alarm	0750

Table B.7 Any Alarm

		Read Only: 0 = Alarm group inactive 1 = Alarm group active	
Title	Coil Number	Title	Coil Number
Alarm Group 1	0751	Alarm Group 7	0757
Alarm Group 2	0752	Alarm Group 8	0758
Alarm Group 3	0753	Alarm Group 9	0759
Alarm Group 4	0754	Alarm Group 10	0760
Alarm Group 5	0755	Alarm Group 11	0761
Alarm Group 6	0756	Alarm Group 12	0762

Table B.8 Alarm Groups

		Read Only: 0 = Real time alarm inactive 1 = Real time alarm active	
Title	Coil Number	Title	Coil Number
Real Time Alarm 1	0851		
Real Time Alarm 2	0852		
Real Time Alarm 3	0853		
Real Time Alarm 4	0854		

Table B.9 Real Time Alarms

Signal		Channel											
		1.1	1.2	1.3	1.4	1.5	1.6	2.1	2.2	2.3	2.4	2.5	2.6
Channel Fail Status	Read Only	1001	1031	1061	1091	1241	1271	1121	1151	1181	1211	1301	1331
Alarm A	Read Only	1002	1032	1062	1092	1242	1272	1122	1152	1182	1212	1302	1332
Alarm B	Read Only	1003	1033	1063	1093	1243	1273	1123	1153	1183	1213	1303	1333
Alarm C	Read Only	1004	1034	1064	1094	1244	1274	1124	1154	1184	1214	1304	1334
Alarm D	Read Only	1005	1035	1065	1095	1245	1275	1125	1155	1185	1215	1305	1335
Alarm A Acknowledge	Read/Write	1006	1036	1066	1096	1246	1276	1126	1156	1186	1216	1306	1336
Alarm B Acknowledge	Read/Write	1007	1037	1067	1097	1247	1277	1127	1157	1187	1217	1307	1337
Alarm C Acknowledge	Read/Write	1008	1038	1068	1098	1248	1278	1128	1158	1188	1218	1308	1338
Alarm D Acknowledge	Read/Write	1009	1039	1069	1099	1249	1279	1129	1159	1189	1219	1309	1339
Totalizer A Stop/Go	Read/Write	1010	1040	1070	1100	1250	1280	1130	1160	1190	1220	1310	1340
Totalizer A Reset	Read/Write	1011	1041	1071	1101	1251	1281	1131	1161	1191	1221	1311	1341
Totalizer A Wrap	Read Only	1012	1042	1072	1102	1252	1282	1132	1162	1192	1222	1312	1342
Totalizer A First Stage	Read Only	1013	1043	1073	1103	1253	1283	1133	1163	1193	1223	1313	1343
Totalizer A Flowrate Fail	Read Only	1014	1044	1074	1104	1254	1284	1134	1164	1194	1224	1314	1344
Totalizer B Stop/Go	Read/Write	1015	1045	1075	1105	1255	1285	1135	1165	1195	1225	1315	1345
Totalizer B Reset	Read/Write	1016	1046	1076	1106	1256	1286	1136	1166	1196	1226	1316	1346
Totalizer B Wrap	Read Only	1017	1047	1077	1107	1257	1287	1137	1167	1197	1227	1317	1347
Totalizer B First Stage	Read Only	1018	1048	1078	1108	1258	1288	1138	1168	1198	1228	1318	1348
Totalizer B Flowrate Fail	Read Only	1019	1049	1079	1109	1259	1289	1139	1169	1199	1229	1319	1349
Channel Type	Read Only	1020	1050	1080	1110	1260	1290	1140	1170	1200	1230	1320	1350
Digital Value	Read Only	1021	1051	1081	1111	1261	1291	1141	1171	1201	1231	1321	1351

Table B.10 Channel Digital Signals

B.5 Operating Mode Modbus Registers

Tables B.11 to B.13 detail the contents of the Modbus TCP registers accessible while the recorder is in the operating mode.

Two data types are used:

- 32-bit single precision floating point data in IEEE format
- 64-bit double precision floating point data in IEEE format

Note.

- When writing to a parameter that occupies more than one register position then all registers relating to that parameter MUST be written to as part of a multiple register write. If this is not achieved a NAK exception response is issued. Individual registers can be read without causing an exception response.
- When accessing a parameter that occupies more than one register position, the lowest numbered register contains the most significant data.

Analog Input	Modbus Register
A1	0001 and 0002
B1	0003 and 0004
B2	0009 and 0010
C1	0005 and 0006
C2	0011 and 0012
D1	0007 and 0008
D2	0013 and 0014

Read Only, single precision IEEE floating point number

Table B.11 Analog Inputs

Alarm	Trip Point Registers	Alarm	Trip Point Registers	Alarm	Trip Point Registers	Alarm	Trip Point Registers
1.1A	0101 and 0102	1.4A	0125 and 0126	2.1A	0133 and 0134	2.4A	0157 and 0158
1.1B	0103 and 0104	1.4B	0127 and 0128	2.1B	0135 and 0136	2.4B	0159 and 0160
1.1C	0105 and 0106	1.4C	0129 and 0130	2.1C	0137 and 0138	2.4C	0161 and 0162
1.1D	0107 and 0108	1.4D	0131 and 0132	2.1D	0139 and 0140	2.4D	0163 and 0164
1.2A	0109 and 0110	1.5A	0165 and 0166	2.2A	0141 and 0142	2.5A	0181 and 0182
1.2B	0111 and 0112	1.5B	0167 and 0168	2.2B	0143 and 0144	2.5B	0182 and 0184
1.2C	0113 and 0114	1.5C	0169 and 0170	2.2C	0145 and 0146	2.5C	0185 and 0186
1.2D	0115 and 0116	1.5D	0171 and 0172	2.2D	0147 and 0148	2.5D	0187 and 0188
1.3A	0117 and 0118	1.6A	0173 and 0174	2.3A	0149 and 0150	2.6A	0189 and 0190
1.3B	0119 and 0120	1.6B	0175 and 0176	2.3B	0151 and 0152	2.6B	0191 and 0192
1.3C	0121 and 0122	1.6C	0177 and 0178	2.3C	0153 and 0154	2.6C	0193 and 0194
1.3D	0123 and 0124	1.6D	0179 and 0180	2.3D	0155 and 0156	2.6D	0195 and 0196

Table B.12 Alarm Trip Levels

	Current Batch				Previous Batch			
	IEEE	IEEE	IEEE	Double Precision Floating Point	IEEE	IEEE	IEEE	Double Precision Floating Point
Totalizer	Maximum Flowrate	Minimum Flowrate	Average Flowrate	Batch Total	Maximum Flowrate	Minimum Flowrate	Average Flowrate	Batch Total
1.1A	0251 and 0252	0301 and 0302	0351 and 0352	0401 to 0404	0551 and 0552	0601 and 0602	0651 and 0652	0701 to 0704
1.1B	0253 and 0254	0303 and 0304	0353 and 0354	0405 to 0408	0553 and 0554	0603 and 0604	0653 and 0654	0705 to 0708
1.2A	0255 and 0256	0305 and 0306	0355 and 0356	0409 to 0412	0555 and 0556	0605 and 0606	0655 and 0656	0409 to 0412
1.2B	0257 and 0258	0307 and 0308	0357 and 0358	0413 to 0416	0557 and 0558	0607 and 0608	0657 and 0658	0713 to 0716
1.3A	0259 and 0260	0309 and 0310	0359 and 0360	0417 to 0420	0559 and 0560	0609 and 0610	0659 and 0660	0717 to 0720
1.3B	0261 and 0262	0311 and 0312	0361 and 0362	0421 to 0424	0561 and 0562	0611 and 0612	0661 and 0662	0721 to 0724
1.4A	0263 and 0264	0313 and 0314	0363 and 0364	0425 to 0428	0563 and 0564	0613 and 0614	0663 and 0664	0725 to 0728
1.4B	0265 and 0266	0315 and 0316	0365 and 0366	0429 to 0432	0565 and 0566	0615 and 0616	0665 and 0666	0729 to 0732
1.5A	0283 and 0284	0333 and 0334	0383 and 0384	0465 to 0468	0583 and 0584	0633 and 0634	0683 and 0684	0765 to 0768
1.5B	0285 and 0286	0335 and 0336	0385 and 0386	0469 to 0472	0585 and 0586	0635 and 0636	0685 and 0686	0769 to 0772
1.6A	0287 and 0288	0337 and 0338	0387 and 0388	0473 to 0476	0587 and 0588	0637 and 0638	0687 and 0688	0773 to 0776
1.6B	0289 and 0290	0339 and 0340	0389 and 0390	0477 to 0480	0589 and 0590	0639 and 0640	0689 and 0690	0777 to 0780
2.1A	0267 and 0268	0317 and 0318	0367 and 0368	0433 to 0436	0567 and 0568	0617 and 0618	0667 and 0668	0733 to 0736
2.1B	0269 and 0270	0319 and 0320	0369 and 0370	0437 to 0440	0569 and 0570	0619 and 0620	0669 and 0670	0737 to 0740
2.2A	0271 and 0272	0321 and 0322	0371 and 0372	0441 to 0444	0571 and 0572	0621 and 0622	0671 and 0672	0441 to 0444
2.2B	0273 and 0274	0323 and 0324	0373 and 0374	0445 to 0448	0573 and 0574	0623 and 0624	0673 and 0674	0745 to 0748
2.3A	0275 and 0276	0325 and 0326	0375 and 0376	0449 to 0452	0575 and 0576	0625 and 0626	0675 and 0676	0749 to 0752
2.3B	0277 and 0278	0327 and 0328	0377 and 0378	0453 to 0456	0577 and 0578	0627 and 0628	0677 and 0678	0753 to 0756
2.4A	0279 and 0280	0329 and 0330	0379 and 0380	0457 to 0460	0579 and 0580	0629 and 0630	0679 and 0680	0757 to 0760
2.4B	0281 and 0282	0331 and 0332	0381 and 0382	0461 to 0464	0581 and 0582	0631 and 0632	0681 and 0682	0761 to 0764
2.5A	0291 and 0292	0341 and 0342	0391 and 0392	0481 to 0484	0591 and 0592	0641 and 0642	0691 and 0692	0781 to 0784
2.5B	0293 and 0294	0343 and 0344	0393 and 0394	0485 to 0488	0593 and 0594	0643 and 0644	0693 and 0694	0785 to 0788
2.6A	0295 and 0296	0345 and 0346	0395 and 0396	0489 to 0492	0595 and 0596	0645 and 0646	0695 and 0696	0789 to 0792
2.6B	0297 and 0298	0347 and 0348	0397 and 0398	0493 to 0496	0597 and 0598	0647 and 0648	0697 and 0698	0793 to 0796

Table B.13 Totalizer Totals

B.6 Communications – Analog and Digital Inputs

	Comms. Digital Inputs	Comms. Analog Inputs Failure	Comms. Analog Inputs
	Read/Write: 0 = Inactive 1 = Active		Floating point (-999 to 9999)
Input Number	Coil Number	Coil Number	Registers
1	0601	0651	0851 and 0852
2	0602	0652	0853 and 0854
3	0603	0653	0855 and 0856
4	0604	0654	0857 and 0858
5	0605	0655	0859 and 0860
6	0606	0656	0861 and 0862
7	0607	0657	0863 and 0864
8	0608	0658	0865 and 0866
9	0609	0659	0867 and 0868
10	0610	0660	0869 and 0870
11	0611	0661	0871 and 0872
12	0612	0662	0873 and 0874

	Comms. Digital Inputs	Comms. Analog Inputs Failure	Comms. Analog Inputs
	Read/Write: 0 = Inactive 1 = Active		Floating point (-999 to 9999)
Input Number	Coil Number	Coil Number	Registers
13	0613	0663	0875 and 0876
14	0614	0664	0877 and 0878
15	0615	0665	0879 and 0880
16	0616	0666	0881 and 0882
17	0617	0667	0883 and 0884
18	0618	0668	0885 and 0886
19	0619	0669	0887 and 0888
20	0620	0670	0889 and 0890
21	0621	0671	0891 and 0892
22	0622	0672	0893 and 0894
23	0623	0673	0895 and 0896
24	0624	0674	0897 and 0898
Reserved	0625 to 0650	0675 to 0700	0899 to 1000

Table B.14 Modbus Inputs

		Channel											
Signal		1.1	1.2	1.3	1.4	1.5	1.6	2.1	2.2	2.3	2.4	2.5	2.6
Channel Input	Read Only	1001 and 1002	1051 and 1052	1101 and 1102	1151 and 1152	1401 and 1402	1451 and 1452	1201 and 1202	1251 and 1252	1301 and 1302	1351 and 1352	1501 and 1502	1551 and 1552
Alarm A Trip	Read/Write	1003 and 1004	1053 and 1054	1103 and 1104	1153 and 1154	1403 and 1404	1453 and 1454	1203 and 1204	1253 and 1254	1303 and 1304	1353 and 1354	1503 and 1504	1553 and 1554
Alarm B Trip	Read/Write	1005 and 1006	1055 and 1056	1105 and 1106	1155 and 1156	1405 and 1406	1455 and 1456	1205 and 1206	1255 and 1256	1305 and 1306	1355 and 1356	1505 and 1506	1555 and 1556
Alarm C Trip	Read/Write	1007 and 1008	1057 and 1058	1107 and 1108	1157 and 1158	1407 and 1408	1457 and 1458	1207 and 1208	1257 and 1258	1307 and 1308	1357 and 1358	1507 and 1508	1557 and 1558
Alarm D Trip	Read/Write	1009 and 1010	1059 and 1060	1109 and 1110	1159 and 1160	1409 and 1410	1459 and 1460	1209 and 1210	1259 and 1260	1309 and 1310	1359 and 1360	1509 and 1510	1559 and 1560
Current Batch	Totalizer A Max	1011 and 1012	1061 and 1062	1111 and 1112	1161 and 1162	1411 and 1412	1461 and 1462	1211 and 1212	1261 and 1262	1311 and 1312	1361 and 1362	1511 and 1512	1561 and 1562
	Totalizer A Min	1013 and 1014	1063 and 1064	1113 and 1114	1163 and 1164	1413 and 1414	1463 and 1464	1213 and 1214	1263 and 1264	1313 and 1314	1363 and 1364	1513 and 1514	1563 and 1564
	Totalizer A Average	1015 and 1016	1065 and 1066	1115 and 1116	1165 and 1166	1415 and 1416	1465 and 1466	1215 and 1216	1265 and 1266	1315 and 1316	1365 and 1366	1515 and 1516	1565 and 1566
	Totalizer A Total	1017 to 1020	1067 to 1070	1117 to 1120	1167 to 1170	1417 to 1420	1467 to 1470	1217 to 1220	1267 to 1270	1317 to 1320	1367 to 1370	1517 to 1520	1567 to 1570
Previous Batch	Totalizer A Max	1021 and 1022	1071 and 1072	1121 and 1122	1171 and 1172	1421 and 1422	1471 and 1472	1221 and 1222	1271 and 1272	1321 and 1322	1371 and 1372	1521 and 1522	1571 and 1572
	Totalizer A Min	1023 and 1024	1073 and 1074	1123 and 1124	1173 and 1174	1423 and 1424	1473 and 1474	1223 and 1224	1273 and 1274	1323 and 1324	1373 and 1374	1523 and 1524	1573 and 1574
	Totalizer A Average	1025 and 1026	1075 and 1076	1125 and 1126	1175 and 1176	1425 and 1426	1475 and 1476	1225 and 1226	1275 and 1276	1325 and 1326	1375 and 1376	1525 and 1526	1575 and 1576
	Totalizer A Total	1027 to 1030	1077 to 1080	1127 to 1130	1177 to 1180	1427 to 1430	1477 to 1480	1227 to 1230	1277 to 1280	1327 to 1330	1377 to 1380	1527 to 1530	1577 to 1580

Table B.15 Channel Data

		Channel												
		1.1	1.2	1.3	1.4	1.5	1.6	2.1	2.2	2.3	2.4	2.5	2.6	
Current Batch	Signal	Read Only	1031 and 1032	1081 and 1082	1131 and 1132	1181 and 1182	1431 and 1432	1481 and 1482	1231 and 1232	1281 and 1282	1331 and 1332	1381 and 1382	1531 and 1532	1581 and 1582
	Totalizer B Max	Read Only	1033 and 1034	1083 and 1084	1133 and 1134	1183 and 1184	1433 and 1434	1483 and 1484	1233 and 1234	1283 and 1284	1333 and 1334	1383 and 1384	1533 and 1534	1583 and 1584
	Totalizer B Min	Read Only	1035 and 1036	1085 and 1086	1135 and 1136	1185 and 1186	1435 and 1436	1485 and 1486	1235 and 1236	1285 and 1286	1335 and 1336	1385 and 1386	1535 and 1536	1585 and 1586
	Totalizer B Average	Read Only	1037 to 1040	1087 to 1090	1137 to 1140	1187 to 1190	1437 to 1440	1487 to 1490	1237 to 1240	1287 to 1290	1337 to 1340	1387 to 1390	1537 to 1540	1587 to 1590
Previous Batch	Totalizer B Total	Read Only	1041 and 1042	1091 and 1092	1141 and 1142	1191 and 1192	1441 and 1442	1491 and 1492	1241 and 1242	1291 and 1292	1341 and 1342	1391 and 1392	1541 and 1542	1591 and 1592
	Totalizer B Max	Read Only	1043 and 1044	1093 and 1094	1143 and 1144	1193 and 1194	1443 and 1444	1493 and 1494	1243 and 1244	1293 and 1294	1343 and 1344	1393 and 1394	1543 and 1544	1593 and 1594
	Totalizer B Min	Read Only	1045 and 1046	1095 and 1096	1145 and 1146	1195 and 1196	1445 and 1446	1495 and 1496	1245 and 1246	1295 and 1296	1345 and 1346	1395 and 1396	1545 and 1546	1595 and 1596
	Totalizer B Average	Read Only	1047 to 1050	1097 to 1100	1147 to 1150	1197 to 1200	1447 to 1450	1497 to 1500	1247 to 1250	1297 to 1300	1347 to 1350	1397 to 1400	1547 to 1550	1597 to 1600

Table B.15 Channel Data (Continued)

Group 1		Group 2	
Batch Field	Modbus Registers	Batch Field	Modbus Registers
Batch Number	1701 to 1720	Batch Number	1801 to 1820
Field 1	1726 to 1745	Field 1	1826 to 1845
Field 2	1751 to 1770	Field 2	1851 to 1870
Field 3	1776 to 1795	Field 3	1876 to 1895

Table B.16 Batch Fields (Unicode Format as Table B.18 but Prefixed with '00').

Read/ Write: ASCII Character Code – see Table B.18					
Input	Register Number	Input	Register Number	Input	Register Number
Character 1	0951	Character 8	0958	Character 15	0965
Character 2	0952	Character 9	0959	Character 16	0966
Character 3	0953	Character 10	0960	Character 17	0967
Character 4	0954	Character 11	0961	Character 18	0968
Character 5	0955	Character 12	0962	Character 19	0969
Character 6	0956	Character 13	0963	Character 20	0970
Character 7	0957	Character 14	0964		

Table B.17 Remote Operator Messages

Hex	Dec	Char	Hex	Dec	Char	Hex	Dec	Char	Hex	Dec	Char	Hex	Dec	Char
20	32	Space	34	52	4	47	71	G	5A	90	Z	6D	109	m
21	33	!	35	53	5	48	72	H	5B	91	[6E	110	n
22	34	"	36	54	6	49	73	I	5C	92	\	6F	111	o
23	35	#	37	55	7	4A	74	J	5D	93]	70	112	p
24	36	\$	38	56	8	4B	75	K	5E	94	^	71	113	q
25	37	%	39	57	9	4C	76	L	5F	95	_	72	114	r
26	38	&	3A	58	:	4D	77	M	60	96	N/A	73	115	s
27	39	`	3B	59	;	4E	78	N	61	97	a	74	116	t
28	40	(3C	60	<	4F	79	O	62	98	b	75	117	u
29	41)	3D	61	=	50	80	P	63	99	c	76	118	v
2A	42	*	3E	62	>	51	81	Q	64	100	d	77	119	w
2B	43	+	3F	63	?	52	82	R	65	101	e	78	120	x
2C	44	N/A	40	64	@	53	83	S	66	102	f	79	121	y
2D	45	-	41	65	A	54	84	T	67	103	g	7A	122	z
2E	46	.	42	66	B	55	85	U	68	104	h	7B	123	{
2F	47	/	43	67	C	56	86	V	69	105	i	7C	124	
30	48	0	44	68	D	57	87	W	6A	106	j	7D	125	}
31	49	1	45	69	E	58	88	X	6B	107	k	7E	126	~
32	50	2	46	70	F	59	89	Y	6C	108	l	7F	127	N/A
33	51	3												

Hex	Dec	Char
A3	163	£
B0	176	°
B2	178	²
B3	179	³
B5	181	µ
3A9	937	Ω

Note. Character codes 2C, 60 and 7F Hex (44, 96 and 127 Dec) are not supported

Table B.18 ASCII Character Set for Remote Operator Messages

Appendix C – Storage Capacity

C.1 Internal Storage Capacity

Approximate duration calculated for continuous recording of 4 channels of analog data (for 8 channels divide by 2; for 2 channels multiply by 2 etc.).

Sample Rate	1 second	10 seconds	40 seconds	60 seconds	120 seconds	480 seconds
64Mb internal Flash memory	48 days	16 months	5 years	8 years	16 years	56 years

Table C.1 Internal Storage Capacity

C.2 External Storage Capacity

Approximate duration calculated for continuous recording of 4 channels of analog data (for 8 channels divide by 2; for 2 channels multiply by 2 etc.).

Sample Rate	SD Card Size			
	128Mb	256Mb	512Mb	1Gb
1.0 second	28 days	8 weeks	16 weeks	7 months
10.0 seconds	9 months	19 months	3 years	6 years

Table C.2 External (Archive) Storage Capacity – Text Formatted Archive Files

Sample Rate	SD Card Size			
	128Mb	256Mb	512Mb	1Gb
1.0 second	3 months	6 months	12 months	2 years
10.0 seconds	2.5 years	5 years	10 years	20 years

Table C.3 External (Archive) Storage Capacity – Binary Formatted Archive Files

Appendix D – Units

Unit	Description
deg F	Degrees Fahrenheit
Kelvin	Degrees Kelvin
%RH	% Relative Humidity
%	%
ppm	parts per million
ppb	parts per billion
pH	potential Hydrogen
l/d	liters per day
l/h	liters per hour
l/m	liters per minute
l/s	liters per second
MI/d	megaliters per day
MI/h	megaliters per hour
MI/m	megaliters per minute
MI/s	megaliters per second
gal/d (UK)	imperial gallons per day
gal/h (UK)	imperial gallons per hour
gal/m (UK)	imperial gallons per minute
gal/s (UK)	imperial gallons per second
Mgal/d (UK)	imperial mega gallons per day
gal/d (US)	US gallons per day
gal/h (US)	US gallons per hour
gal/m (US)	US gallons per minute
gal/s (US)	US gallons per second
Mgal/d (US)	US mega gallons
m ³ /d	cubic meters per day
m ³ /h	cubic meters per hour
m ³ /m	cubic meters per minute
m ³ /s	cubic meters per second
ft ³ /d	cubic feet per day
ft ³ /h	cubic feet per hour

Unit	Description
lb/d	pounds per day
lb/h	pounds per hour
lb/m	pounds per minute
lb/s	pounds per second
ton/d	imperial tons per day
ton/h	imperial tons per hour
ton/m	imperial tons per minute
ton/s	imperial tons per second
ug/kg	micrograms per kilogram
mg/kg	milligrams per kilogram
mbar	millibar
bar	bar
m WG	meters water gauge
Hz	hertz
kHz	kilohertz
% sat	% saturation
%O ₂	% oxygen
%N ₂	% nitrogen
%HCl	% hydrochloric acid
NTU	nephelometric turbidity units
FTU	formazine turbidity units
%OBS	% obscuration
g/l	grams per liter
g/h	grams per hour
g/d	grams per day
ml/m	milliliters per minute
ml/h	milliliters per hour
%dO ₂	% dissolved oxygen
uV	microvolts
mV	millivolts
MV	megavolts

Table D.1 Engineering Units

Unit	Description
ft ³ /m	cubic feet per minute
ft ³ /s	cubic feet per second
SCFM	standard cubic feet per minute
kg/d	kilograms per day
kg/h	kilograms per hour
kg/m	kilograms per minute
kg/s	kilograms per second
T/d	metric tonnes per day
T/h	metric tonnes per hour
T/m	metric tonnes per minute
T/s	metric tonnes per second

Unit	Description
A	amps
mho	conductance
S	Siemens
uS/cm	microSiemens per centimeter
mS/cm	milliSiemens per centimeter
uS/m	microSiemens per meter
mS/m	milliSiemens per meter
Feet	imperial feet
Inches	imperial inches
Custom	user defined units

Table D.1 Engineering Units (Continued)

Unit	Description
l	liters
ml	milliliters
kl	kiloliters
Ml	megaliters
m	meters
gal (UK)	imperial gallons
g x 10 (UK)	imperial gallons x 10
g x100 (UK)	imperial gallons x 100
kgal (UK)	imperial kilo gallons
Mgal (UK)	imperial mega gallons
gal (US)	us gallons
g x 10 (US)	us gallons x 10
g x100 (US)	us gallons x 100
kgal (US)	us kilo gallons
Mgal (US)	us mega gallons

Unit	Description
m ³	cubic meters
km ³	kilo cubic meters
Mm ³	mega cubic meters
CUMEC	cubic meter of water per second
kg	kilograms
T	tons
kT	kilotons
lb	pounds
ton	imperial tons
btu	british thermal units
ft ³	cubic feet
kft ³	kilo cubic feet
Mft ³	mega cubic feet
AcreFt	volume of water, 1ft deep, covering an area of 1 acre
Custom	user defined units

Table D.2 Totalizer Units

Appendix E – Math Equations

Individual recording channel signals, analog and digital sources can be combined in a math equation to produce a customized recording channel or retransmission source.

Typical examples include adding/subtracting the values of a number of analog sources together to form one recording channel.

More complex blocks can also be created to determine relative humidity or sterilization FValue.

Digital signals can be used in math equations to enable/disable the output when certain conditions are true.

This is an example of a typical math equation:

$$m1 = a1 + 52.4 \times \text{Log}(a2) - md2$$

Where:

- m1 = Math result (can be assigned to recording channels, other math equations etc.)
- a1 = Analog Source
- 52.4 = Constant (can be any numerical value of up to 3 decimal places)
- Log(a2) = Function – see Table E.1. page 166
- md2 = Digital source

Note.

- Operators are evaluated from left to right therefore the above equation is evaluated as: $[(a1 + 52.4) \times \text{Log}(a2)] - md2$ and **NOT** as $a1 + (52.4 \times \text{Log}(a2)) - md2$.
- Functions cannot be nested within other functions. To enter an equation requiring nested functions it is necessary to use another math block, e.g. to evaluate the equation:
$$\frac{a1 + a2}{52.4 - a3}$$
 proceed as follows:
 - Enter math block 1 as $m1 = a1 + a2/m2$
 - Enter math block 2 as $m2 = 52.4 - a3$
- Digital signals (md1 to md3) are evaluated as 0 (inactive) and 1 (active), therefore in the example:
 $m1 = a1 + a2 \times md1$
the sum of $(a1 + a2)$ is set to zero if the digital input md1 is also zero.

E.1 Math Functions

Function	Description
Trigonometric Functions:	
Sin(x)	The sine of x (x specified in radians, Rad = $\pi/180^\circ$)
Cos(x)	The cosine of x (x specified in radians, Rad = $\pi/180^\circ$)
Tan(x)	The tangent of x (x specified in radians, Rad = $\pi/180^\circ$)
Statistical Functions:	
Avg(x, n, t)	The average of variable x, over n samples at a sample rate of t seconds. n=1 to 9999 samples, t=1 to 9999 seconds. The average resets after n samples.
Rav(x, n, t)	The rolling average of variable x, over n samples at a sample rate of t seconds. The oldest sample in each Rav calculation is lost and the new result is calculated by taking into account the current sample. N=1 to 9999 samples, T=1 to 9999 seconds.
Sd(x, n, t)	Standard Deviation of variable x, over n samples at a sample rate of t seconds. N = 1 to 200 samples; t = 1 to 9999 seconds.
Logarithmic Functions:	
Log(x)	Log base 10 of x. For Antilog, see X^a (x, a)
Ln(x)	Natural log of x
Exp(x)	e to the power x
Special Functions:	
RH(x, y)	Relative humidity calculation using wet(x) & dry(y) bulb readings – see Section E.2, page 167
F0(x, y, z)	Optimization of sterilization times using F0 calculation and measured temperature(x), target temperature(y) and Z factor(z)
Abs(x)	The absolute value of variable x
Switch Functions:	
Hs(x, y, z)	Returns the variable with the greatest magnitude
Ms(x, y, z)	Returns the variable whose magnitude is between the upper & lower limits of the three variables
Ls(x, y, z)	Returns the variable with the smallest magnitude
Mux(x, y, s)	Selects x if s is false, otherwise y
Power Functions:	
X^a (x, a)	Raises the variable x to the power a
Sqr(x)	Returns the square root of variable x

Table E.1 Math Functions

E.2 Relative Humidity Calculation

Relative humidity is calculated using the following formula:

$$RH = 100 \times \frac{VPSw - AP \times (Td - Tw)}{VPSd}$$

Where:

VPSw = Saturation Vapor Pressure at Wet Bulb Temperature

VPSd = Saturation Vapor Pressure at Dry Bulb Temperature

Td = Dry Bulb Temperature

Tc = Wet Bulb Temperature

P = Total Atmospheric Pressure (1000 mbar)

A = Psychometric Constant (6.66 x 10⁻⁴)

RH = % of Relative Humidity

A relative humidity calculation requires two inputs, one from a wet bulb sensor and one from a dry bulb sensor. Both of these inputs are incorporated into the equation as analog.

RH tables are based on the use of an aspirated psychrometer having an air velocity of at least 11.5 feet per second or 3.5 meters per second across the bulb sensors.

Inputs used for wet and dry bulb measurement must be in the ranges 0 to 100°C or 32 to 212°F. The result must be set to 0 to 100.0% RH.

Fig. E.1 (page 168) is an example of configuring a math block to perform a relative humidity calculation.

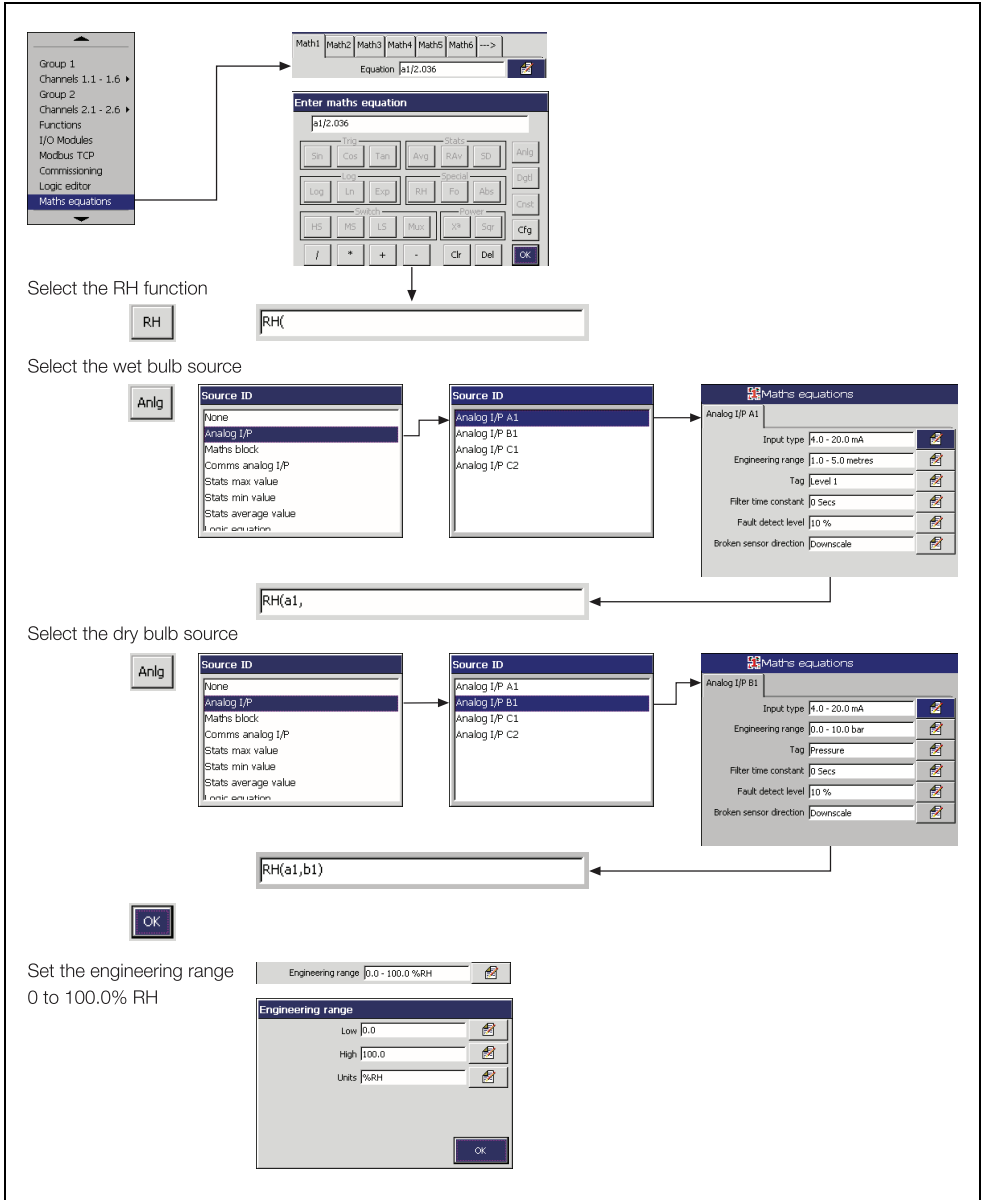

Fig. E.1 Relative Humidity Calculation

E.3 Sterilization Fvalue Calculation

The ability of heat to kill micro-organisms varies with the type of organism and increases exponentially with rising temperature.

Therefore, the time taken in sterilization is reduced if the target temperature is increased and the time spent approaching and receding from the target temperature can be taken into account.

Example – an increase of 10°C from 121.1 to 131.1°C in the steam sterilizing temperature of the *Bacillus stearo-thermophilus* organism increases the death rate by a factor of ten.

The change in sterilization temperature which causes a factor of 10 change in the death rate is unique to each organism and is called the Z value.

Although 121.1°C is universally accepted as a reference for steam sterilization processes, the actual sterilizing temperature varies, depending on the products involved and on each sterilization process.

The Fvalue is calculated using the general formula:

$$F_{val(t)} = F_{val(t-1)} + \frac{\left(10^{\frac{x-y}{z}}\right)}{60}$$

Where

$F_{val(t)}$ = Current Fvalue

$F_{val(t-1)}$ = Fvalue at last sample

x = Actual temperature

y = Target temperature

z = Z-factor (i.e. the temperature interval representing a factor of 10 reduction in killing efficiency)

Example – A typical steam sterilizing cycle – see Fig. E.2.

The period AB is the chamber evacuation part of the cycle, when the chamber is alternatively evacuated and purged with steam to remove air. The ramp up to final sterilizing temperature starts at B. The thermal conductivity of the load determines the time taken to achieve point D, but is typically 30% of the total cycle time. It is in the area, C D, and E F, that Fvalues make their contribution to shortening sterilization time, by accumulating credit for the time spent approaching and receding from the sterilizing temperature.

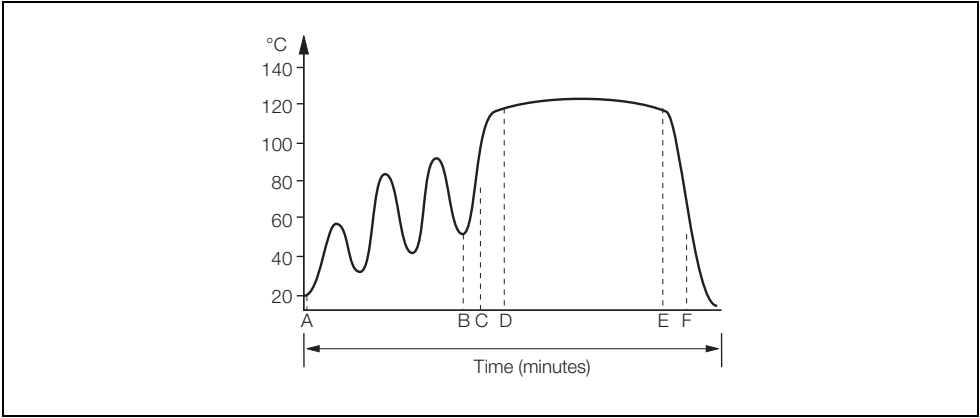

Fig. E.2 Typical Steam Sterilization Cycle

It is important to note the large change in equivalent sterilizing time which results from a small increase in the sterilizing temperature. Going from 121°C to 122°C, an increase of only 1°C, reduces the time needed to kill an equal number of organisms by a factor of 26%. Likewise, a measurement error which results in the set point being 1°C too low could result in a product not being sterilized properly.

As the Fvalue calculation is essentially a logarithmic function, the effect of measurement errors is significant on the resultant Fvalue.

Table E.2 shows the resultant error in the Fvalue resulting from various measurement errors with a Z value of 10°C.

Temperature Error (°C)	Fvalue Error (F0)
0.1	2.3%
-0.1	-2.3%
0.5	12.0%
-0.5	-11.0%
1.0	26.0%

Table E.2 Fvalue Accuracy

The recorder can measure TC and RTD inputs with an accuracy of better than 0.1%. This results in superior Fvalue calculation accuracy.

To improve the accuracy further, the 'Input Adjustment' facility (see Section 7.10.1, page 117) can be used to adjust the individual channel readings to be correct at the sterilizing temperature.

As Fvalue calculation is an integrating function, the sample rate has a direct effect on the accuracy when the temperature is changing. With a steady state signal the sample rate does not affect accuracy.

Fig. E.3 is an example of configuring a math block to perform a sterilization Fvalue calculation.

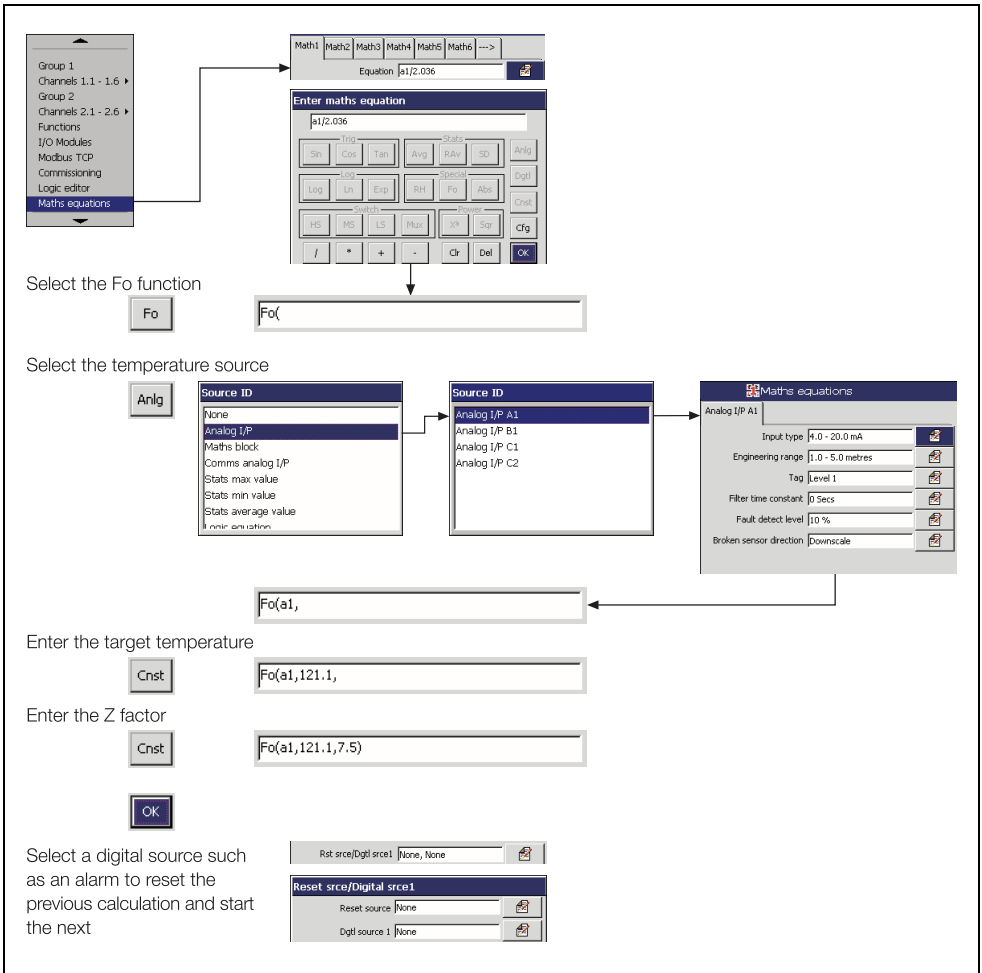
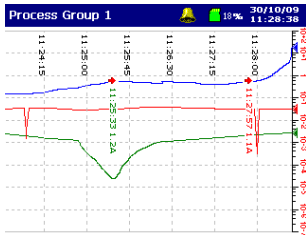

Fig. E.3 Sterilization Fvalue Calculation

E.4 Logarithmic Scales

When 'Scale Type' is set to 'Log' (see page 95), the Chart view's scale bar and graduations are displayed in logarithmic format with the input signal plotted linearly on the chart:



The recorded value in the Chart and Indicator views is driven by the engineering range selected and displayed in exponential format:

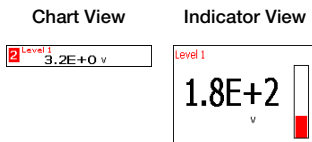

Example

An application requires a 4 to 20 mA input signal with an associated engineering range of 0 to 1,000,000 to be displayed in exponential format and plotted on a logarithmic chart with a scale of 1 to 10^{+6} .

1. Referring to page 95:
 - a. Set 'Scale Type' to 'Log'
 - b. Set 'Low' to '1'
 - c. Set 'High' to '1.0E+6'
2. Referring to page 97:
 - a. Set Engineering range 'Low' to '0'
 - b. Set Engineering range 'High' to '6'

Note. The logarithmic value of the input is obtained by displaying '10 to the power of the engineering range value'. Therefore, in the case of 0 to 1,000,000, the engineering range must be set to 0 to 6 as $10^{+6} = 1,000,000$.

- c. Select Engineering Units as required

In this configuration, the input is plotted linearly on the chart but the digital indicator displays the input in exponential (logarithmic) format in order to match the logarithmic scale displayed on the chart.

Note. Regardless of the scale type setting:

- All alarms on the recording channel are triggered by the channel's linear value.
- Data values saved to the archive files are the linear output from the recording channel.

Appendix F – Batch Recording

F.1 Introduction

The recorder's batch recording function enables:

- storage of archived data in batch format
- the operator to identify the batch data by name and/or number
- the operator to enter essential batch information that is then recorded with the data
- the operator to start and stop batch recording from the front panel or via remote signals
- the operator to archive the internally recorded values so that the data for each batch can be easily retrieved and reviewed
- the retrieval of data from the recorder based on its batch identity

In addition, using the Company's DataManager data analysis software package, batched data can be:

- located and retrieved using its batch identity

F.2 Batch Archive Filenames

Batch archive filenames for channel data files are formatted as follows:

Start Time<HHMMSS> Start Date<DDMMYY> Channel <Group>_<Channel> Analog/Digital
<Anlg|Dig> <Instrument Tag>{~DS}{_n}.Vnn

for example: 22454103May11Ch1_1AnlgSM500~DS.V00

An additional batch log archive file is created that contains all the identification data for each batch. These have a filename formatted as follows:



Start Time<HHMMSS> Start Date<DDMMYY> <Instrument Tag>{~DS}{_n}.Xnn

The Alarm Event Log archive files also contain details of all batch start and stop events.

F.3 Operation

F.3.1 Overview

Batch recording can be started and stopped either automatically using a digital signal source (see page 179) or manually from any of the vertical or horizontal chart view operator menus.

Batch start and stop events are recorded in the Alarm Event Log. The  icon is displayed in the log when a batch is started and the  icon is displayed when a batch is stopped. If 'Field 1' is defined during configuration (see page 179) and the operator has entered text in the field (see below), that text is displayed in the 'Event Tag' field of the Alarm Event Log. The batch number or label is displayed in the 'Source Tag' field. The date and time of the event are also displayed.

If 'Chart Annotation' is enabled, batch start and stop events are also displayed in the selected chart view in the format <icon> <time> <Field 1 text> <batch no.>, for example:

 16:56:00 195_R13 Energy Tyre 14.

F.3.2 Starting a Batch Manually

Note. A batch can be started only from the vertical or horizontal chart view operator menus. Press the  key to open the menu.



Start Batch

Note. Displayed only if batch recording has been enabled during Group configuration *and* a batch is not running.

Select to start batch recording. A dialog box is displayed to enable the operator to edit the batch details.

Note. If 'Security system' is set to 'Advanced' (see Section F.4.1, page 177) *and* the operator has the necessary access rights (see Section F.4.2, page 178) *and* 'Operator login' is set to 'Start' or 'Start and Stop' (see page 179), a password entry dialog box is displayed. The correct operator password must be entered to enable the batch to be started.



Enter or edit the batch number or label.

If 'Batch Number' is set to 'Automatic' during configuration (see page 180), this field increments automatically by one each time a batch is started. A number entry pad is displayed when the edit button is selected to enable the batch number to be edited manually.

If 'Batch Number' is set to 'Off' during configuration, this field is blank. A number entry pad is displayed when the edit button is selected to enable a batch number to be entered manually.

If 'Batch Number' is set to 'Text' during configuration, this field is blank. A text entry keyboard is displayed when the edit button is selected to enable a batch label to be entered manually (max. 20 characters).

A configuration dialog box with two rows. The first row is labeled 'Product Type' and contains a text input field with the value 'DPO_R13 Energy Type' and a small edit button icon. The second row is labeled 'Customer' and contains a text input field with the value 'MS-Rover' and a small edit button icon. Below the 'Customer' field is an empty text input field.

Note. These fields are editable only if defined during configuration – see page 180.

Select the relevant edit button to modify each field. A list box is displayed to enable to operator to either select a previously defined entry (max. 10) or to define a new entry (max. 18 characters per field).

An operator login dialog box. It features a text input field labeled 'Operator 1' containing the text 'Operator 1'. Below the input field are two buttons: 'Cancel' and 'OK'.

The operator's name is displayed if 'Operator login' is not set to 'Disabled' – see page 179.

Select 'OK' to accept changes and start batch recording. Select 'Cancel' to return to the chart view without starting batch recording.

F.3.3 Stopping a Batch Manually

Note. A batch can be stopped only from the vertical or horizontal chart view operator menus. Press the  key to open the menu.



Stop Batch

Note. This menu item is displayed only if batch recording has been enabled during Group configuration **and** only if a batch is running.

Select to stop batch recording. A confirmation dialog box is displayed. Select 'Yes' to stop the batch or 'No' to allow the batch to continue.

Note. If 'Security system' is set to 'Advanced' (see Section F.4.1, page 177) **and** the operator has the necessary access rights (see Section F.4.2, page 178) **and** 'Operator login' is set to 'Start and Stop' (see page 179), a password entry dialog box is displayed. The correct operator password must be entered to enable the batch to be stopped.

F.3.4 Historical Review

If the instrument is in Historical Review mode, any previously recorded batch can be reviewed provided the data is still in internal memory.



 Hist

- Goto
- Select Batch
- Exit

Select to move to data recorded in the instrument's onboard memory for a specific batch.

Select Historical Batch

Code	Time	Field 1 Title	Number
05/Sep/06	10:20:34	195_R13 Energy Type	2
05/Sep/06	11:49:23	195_R14 Spd1 Type	3
05/Sep/06	13:32:36	195_R14 Test Type	4
05/Sep/06	13:48:07	195_R14 Test Type	5
05/Sep/06	13:50:08	195_R14 Test Type	6
05/Sep/06	13:51:08	195_R14 Test Type	7
05/Sep/06	13:52:08	195_R14 Test Type	8
05/Sep/06	13:53:14	255_R13 Energy Type	9
05/Sep/06	14:05:11	255_R13 Scorpion	10
05/Sep/06	14:05:21	195_R13 Energy Type	10
05/Sep/06	15:05:10	195_R13 Energy Type	10
05/Sep/06	15:05:42	195_R13 Energy Type	11
05/Sep/06	15:05:42	195_R13 Energy Type	11

Cancel Cursor OK

Select the batch to be reviewed from the list.

The data is displayed from the start of the batch.

F.4 Configuration

F.4.1 Enabling Batch Security

Note. Batch security can be enabled only if the 'Security system' parameter is set to 'Advanced' – see Section 7.6.4, page 78. If the 'Security system' parameter is set to 'Basic', batch security is automatically disabled and cannot be enabled.

To enable batch security, access Common Configuration (see Section 7.6.4, page 78) and select the 'Security ' tab.



Set to 'Advanced' to enable batch security.

F.4.2 Configuring Batch Access Privileges

To enable operators to manually control batches, access Common Configuration (see Section 7.6.5, page 80) and select the 'User ' tab.

The screenshot shows a software interface with a menu bar (Setup, Screen, Time, Security, User) and a list of users. The 'User 1 Access' configuration is selected, showing a dialog box with the following options:

- Logging
- Configuration (No access)
- Configuration (Load)
- Configuration (Ltd)
- Configuration (Full)

Below the dialog, a list of users is shown:

- User 2 Operator 2, No access
- User 3 Operator 3, No access
- User 4 Operator 4, No access

Select 'User 1 Access'.

Ensure the 'Batch' field is ticked to allow User 1 to start and stop batches – see Section F.3, page 174.

Repeat as required for other Users.

Refer to page 179 to set the required type of batch recording security.

F.4.3 Batch Configuration

To configure batch recording, access Process Group Configuration (see Section 7.7, page 84), select the required Process Group and select the 'Batch' tab.



Set to 'On' to enable batch recording for the selected process group.

Note. The following parameters are displayed only if this parameter is set to 'On'.

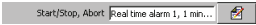

Select a digital signal source to start batch recording on a rising edge and stop batch recording on a falling edge.

Note. If 'Batch Number' (see below) is set to 'Off' or 'Text' and a batch is started using a digital signal, the contents of the 'Batch Number' and batch identification fields (if configured – see next page) are copied automatically to the new batch. If 'Batch Number' is set to 'Automatic', the content of the 'Batch Number' field is incremented by one, automatically.

Select a 'Batch Power Failure' time between 1 minute and 2 hours to enable the 'Abort batch' function. Select 'Off' to disable the function.

If the 'Abort batch' function is enabled and electrical power is lost for more than the 'Batch Power Failure' time selected, the batch is stopped and a digital 'Batch Power Failure' signal is activated for 5 seconds.

Note. The 'Batch Power Failure' value selected affects all groups. The default value is 'Off'.



Select the type of batch recording security required:

- Start – the operator is required to enter a password to start batch recording
- Start and Stop – the operator is required to enter a password to start and stop batch recording
- Disabled – batch recording security is disabled

Note.

- Batch recording security can be enabled only if 'Security system' is set to 'Advanced' (see Section F.4.1, page 177). If 'Security system' is set to 'Basic' this parameter is set automatically to 'Disabled' and the edit button is not displayed.
- If this parameter is set to 'Disabled' no security is required to start or stop batch recording and the operator name is not displayed.

Batch Number	Automatic	
--------------	-----------	---

Select the required batch numbering system:

- Automatic – the batch number increments automatically when a new batch is started, up to a maximum batch number of 9,999,999,999
- Off – a batch number is not assigned automatically but may be entered manually by the operator
- Text – enables the operator to identify the batch with a text string (max. 10 characters)

Note. If set to 'Automatic' or 'Off', this parameter enables the operator to enter a batch number when starting a batch from the operator menu – see Section F.3.2, page 174.

Field 1 Title	Product	
Field 2 Title	Company	
Field 3 Title		

Enter up to 3 identifying labels for the batch, maximum 20 characters per field.

Note.

- Configured fields are shown on the 'New Batch' dialog box that is displayed when the operator starts a batch from the operator menu. This enables the operator to enter further details to identify the batch both on the recorder and when analyzing the archived data using DataManager.
- It is important to configure Field 1 because it is used, together with the batch number, to identify a batch:
 - on chart annotations
 - in the alarm event log
 - during historical review
 - in the DataManager display/search functions

Exit and save the configuration.

Index

A	
Access privileges	82
Accessing the configuration level	67
Advanced security – See Security system: Advanced	
Alarm event log	43, 44
Filter	44
Alarms	28
Acknowledge timeout	106
Acknowledging	34, 40, 44, 74, 88
Access privileges	81, 82
Annunciate	101, 104
Delayed process	103, 105
Event	28
Groups	106
Hysteresis	82, 104
Latch	100, 104
New alarm	28
Process	100, 104
Rate	102, 105
Real-time	116
State recording	106
Tag	104
Type	104
Analog inputs	96
Volt free digital input	96, 99
Archiving	
Archive file format	90
Archive wrap	64, 91
Channel data files	51, 53, 54, 90
Data verification and integrity	62
File names	54
File types	53
Log files	60
Off-line	51, 63
On-line	51, 63
Reset	50
Sample rates	53
Too many files – archiving stopped	63
Warning – too many files	63
Assign to group	
Electronic signatures	37
Audit log	42, 53, 54, 90
B	
Bargraph	5, 38
Enabling	89
Batch access privileges	82, 178
Batch recording	92, 174 to 180
Binary format archive files	59 to 62

C

Channel indicator	
Tags	98, 99
Chart	
Annotation	33, 87
Electronic signatures	37
Scales	30, 33, 88
Linear	95
Logarithmic	95, 172
Traces	28, 33, 88, 94
Views	
Horizontal	27
Vertical	27
Zoning	94
Configuration	
Alarms	100 to 106
Analog input	96 to 98
Electrical range	96
Engineering range	97
Input adjustment	117
Input failure	98
Channel	93 to 111
Chart view	87 to 88
Common	74 to 83
Custom linearizers	115
Data entry dialog boxes	71
Digital input	99
Exiting configuration mode	73
F0 value calculation	112 to 114
I/O modules	117 to 118
Analog inputs	117
Ethernet module	120
Relay modules	119
RS485(Modbus) modules	124
Indicator view	89
Locating parameter settings	70
Number of groups	74
Operator messages	83
Overview	69
Process group	84 to 91
Real time alarms	116
Recording channel setup	93 to 94
Recording parameters	84 to 86
Sample rates	85
Security	65, 78 to 79
Access privileges	82
Inactive user de-activation	79
Passwords	79
Type	78
View/edit other users	80, 81
Totalizers	107 to 111

D

- Date and time 76 to 77
- Daylight saving 30, 59, 60, 77
- Digital inputs
 - Volt free digital input 96, 99
- Displays and controls 25

E

- Electrical installation
 - Cable entry 15
 - Cable glands 15
 - Cable screening connections 15
 - Connections 17
 - AC and DC power supply connections 20
 - Analog/digital input connections 18
 - Transmitter power supply module 21
 - Ethernet cable routing 15
 - Fuses 14, 20
 - Knockout removal 15
 - Relays 21
 - Thermocouple compensating cable 20
- Electronic signatures – See Chart: Electronic signatures 7
- End of life disposal 7
- Engineering units 97, 163
- Ethernet 120

F

- F0 value calculation 112
 - Cut off value 114
 - Preset count 113
 - Tag 112
 - Wrap 112
- File viewer 51
- Filter
 - Mains rejection frequency 117
 - Recording channel input 94
 - Filter time 98
- Functional overview 5
- Functions 115 to 116

H

- Historical Review 31, 174, 176
- Historical review 29, 31, 32, 51
 - Enable 88
 - Exit 31
 - Goto 30

I

Indicator	
Show statistics/totalizers	39
View	38
Enabling menu items	89
Totalizer	89
Input adjustment	50, 82
From operator page	117
<i>See also</i> Configuration: Analog input: Input adjustment	
Installation	11
Environmental limits	9
Mounting dimensions	10
Pipe-mounting	13, 15
Wall-mounting	12
Instrument tag	74

L

Language	74
Linearizer type	96
Linearizer units	96
Logging access	
Advanced security	48
Basic security	47
Logging level	
Menu	50

M

Mains rejection frequency	117
Modbus (RS485)	124
Address	124
Baud rate	124
Parity	124
Modbus TCP	125 to 129, 148
Alarm groups	154
Any alarm	153
Character set for remote operator messages	161
Commands	148
Exception responses	149
Modbus inputs	158
Operator messages	152
Real time alarms	154
Remote operator messages	152, 161
Reverse IEEE data	125
Server (Modbus slave)	125, 126
TCP client access	125, 126
TCP/IP port	125

O

- Offset adjust 118
- On-line help 24, 36, 41, 42, 44, 46, 51
- Operator displays 26
- Operator messages
 - Alarm event log 44
 - Chart view 31, 39, 87, 88
 - Message tag 83
 - Source id 83
 - User defined 31, 39

P

- Panel-mounting 11
- Password entry 49
- Passwords
 - Entry failure limit 79
 - Expiry 79
 - Length 79
- Primary and secondary sample rates 32, 50, 53, 85
- Process group tag 84

R

- Real-time alarms 116
- Recording parameters 84 to 86
- Relays 21
- Reset archiving – See Archiving: Reset
- Resistance thermometer (RTD) 96, 97

S

- Sample rates 28, 32, 50, 53, 87
 - See also Primary and secondary sample rates
- Scale type 95
- Scales – See Chart: Scales
- Screen capture 75
- Screen interval 50, 87
 - Select enable 88
- Screen saver 75
- Security system
 - Advanced 78, 80
 - Basic 78, 80
- Setting the security switch 68
- Setup level
 - Recording control 50
- Signal sources 146
- Simulated inputs 96
- Span adjust 118
- Storage capacity
 - External 162
 - Internal 162
- System administrator 78, 79

T

Text format archive files	54 to 58
Thermocouple compensating cable	20, 118
Totalizer log	45 to 46
F0 values update frequency	114
Filter	46
Update frequency	109
Totalizers	
Count direction	107
Count rate	110
F0 value calculation	112
Preset count	108
Tag	107
Units	107, 164
Wrap	107
Trace	
Width	88

Notes

Sales



Service



Software



ABB Limited

Measurement & Analytics

Oldends Lane, Stonehouse
Gloucestershire,

GL10 3TA

UK

Tel: +44 (0)1453 826661

Fax: +44 (0)1453 829671

Email: instrumentation@gb.abb.com

ABB Limited

Measurement & Analytics

125 E County Line Road

Warminster, PA 18974

USA

Tel: 4008209696

Fax: +86 21 61056677

ABB Limited

Measurement & Analytics

32, Industrial Area, N.I.T.

Faridabad-121001 (Haryana)

India

Tel: +91 129 2448300

Fax: +91 129 2440622

abb.com/measurement



We reserve the right to make technical changes or modify the contents of this document without prior notice. With regard to purchase orders, the agreed particulars shall prevail. ABB does not accept any responsibility whatsoever for potential errors or possible lack of information in this document.

We reserve all rights in this document and in the subject matter and illustrations contained therein. Any reproduction, disclosure to third parties or utilization of its contents – in whole or in parts – is forbidden without prior written consent of ABB.

© ABB 2018