

PGS100 and PAS100

Gauge and absolute pressure transmitters



Engineered solutions for all applications

Measurement made easy

—
PGS100/PAS100 model

Introduction

The present manual provides information on installing, operating, troubleshooting the PGS and PAS pressure transmitter models. Every section of the present manual is specifically dedicated to the specific phase of the transmitter lifecycle starting from the receipt of the transmitter and its identification, passing to the installation, to the electrical connections, to the configuration and to the troubleshooting and maintenance operations, as applicable.

The pressure transmitters model PGS and PAS are field mounted, microprocessor based electronic transmitters. Accurate and reliable measurement of gauge and absolute pressure is provided, in the even most difficult and hazardous industrial environments. These models can be configured to provide specific industrial output signals according to 4 to 20mA with HART digital communication.

For more information

Further publications for PGS and PAS family of pressure products are available for free download from:

www.abb.com/measurement

or by scanning this code:



Download the [Brochure](#) or search for RB/PGS/PAS100-EN on <https://library.abb.com/en>.

Contents

| | | | | | |
|----------|--|----------|----------|---|-----------|
| 1 | Safety | 4 | 4 | Mounting | 9 |
| | General safety information..... | 4 | | General | 9 |
| | Improper use..... | 4 | | IP protection and designation..... | 10 |
| | Technical limit values | 4 | | Mounting the transmitter..... | 10 |
| | Warranty provision | 4 | | Transmitter factory configuration | |
| | Use of instruction | 4 | | consideration | 10 |
| | Operator liability | 5 | | Hazardous area considerations..... | 10 |
| | Qualified personnel | 5 | | Pressure Equipment Directive (PED) | |
| | Returning devices | 5 | | (2014/68/EU) | 10 |
| | Disposal | 5 | | Devices with PS >200 | 10 |
| | Information on WEEE Directive 2012/19/EU | | | Devices with PS ≤ 200 | 10 |
| | (Waste Electrical and Electronic Equipment) | 5 | | Mounting a P style pressure transmitter | 11 |
| | Transport and storage..... | 5 | | Sealing and screw connections..... | 11 |
| | Safety information for electrical installation | 5 | | Moisture..... | 11 |
| | Safety information for inspection and maintenance . | 6 | | Measuring pipe | 12 |
| | Cyber security | 6 | | | |
| | Disclaimer..... | 6 | | | |
| | Communication protocol specific..... | 6 | | | |
| 2 | Transmitter overview | 7 | 5 | Transmitter wiring | 13 |
| | Transmitter components overview | 7 | | Supply requirement | 13 |
| | Range and span consideration | 7 | | Cable connection..... | 13 |
| | | | | Wiring procedure..... | 14 |
| | | | | Grounding | 14 |
| | | | | Output (HART) transmitter wiring..... | 15 |
| | | | | Communication setup | 15 |
| 3 | Opening the box | 8 | 6 | Commissioning | 16 |
| | Identification plates | 8 | | General remarks..... | 16 |
| | Optional wired-on plate | 8 | | Output signal | 16 |
| | Handling and storage..... | 9 | | Output current limits for analog only version .. | 16 |
| | | | | Output current limits for HART and analog | |
| | | | | version (according to NAMUR NE 43 standard). | 16 |
| | | | | Zero/Span and write protection..... | 16 |
| | | | | Local display | 17 |
| | | | | Adjusting lower range value / oblique sensors | 18 |
| | | | | Installing/Removing the LCD display | 19 |
| | | | | Pressure sensor ventilation (PGS100 only) | 20 |

| | | |
|-----------|--|-----------|
| 7 | Operation (only HART version) | 21 |
| | LCD display..... | 21 |
| | Local diagnostic menu..... | 21 |
| | LCD menu structure..... | 21 |
| | Easy setup menu | 22 |
| | | |
| 8 | Error messages | 23 |
| | LCD display messages | 23 |
| | Error states and alarms | 23 |
| | QR code Digital Advanced Diagnostic (DAD) | 26 |
| | QR code Channel Partner Support | 26 |
| | | |
| 9 | Maintenance / Repair | 27 |
| | Returns and removal..... | 27 |
| | | |
| 10 | Hazardous Area considerations | 28 |
| | Special condition for safe use (X)..... | 28 |
| | Explosion protection | 28 |
| | Type-examination certificate/Declaration of conformity..... | 28 |
| | Type of protection “intrinsic safety Ex ia” | 28 |
| | Use in areas with combustible dust..... | 28 |
| | Use of handheld terminal / PC..... | 28 |
| | Hazardous atmospheres..... | 29 |
| | ATEX | 29 |
| | IECEX | 29 |
| | Canadian Standards Association (US)..... | 30 |
| | Canadian Standards Association (Canada) ... | 30 |

1 Safety

General safety information

The “Safety” section provides an overview of the safety aspects to be observed for operation of the device.

The device has been constructed in accordance with the state of the art and is operationally safe. It has been tested and left the factory in perfect working conditions. The information in the manual, as well as the applicable documentation and certificates, must be observed and followed in order to maintain this condition throughout the period of operation. Full compliance with the general safety requirements must be observed during operation of the device. In addition to the general information, the individual sections in the manual contain descriptions of processes or procedural instructions with specific safety information.

Only by observing all of the safety information can you reduce to the minimum the risk of hazards for personnel and/or environment. These instructions are intended as an overview and do not contain detailed information on all available models or every conceivable event that may occur during setup, operation, and maintenance work.

For additional information, or in the event of specific problems not covered in detail by these operating instructions, please contact the manufacturer. In addition, ABB declares that the contents of this manual are not part of any prior or existing agreements, commitments, or legal relationships; nor are they intended to amend these.

All obligations of ABB arise from the conditions of the relevant sales agreement, which also contains the solely binding warranty regulations in full. These contractual warranty provisions are neither extended nor limited by the information provided in this manual.

CAUTION

Only qualified and authorized specialist personnel should be charged with installation, electrical connection, commissioning, and maintenance of the transmitter. Qualified personnel are persons who have experience in installation, electrical wiring connection, commissioning, and operation of the transmitter or similar devices, and hold the necessary qualifications such as:

- Training or instruction, i.e., authorization to operate and maintain devices or systems according to safety engineering standards for electrical circuits, high pressures, and aggressive media
- Training or instruction in accordance with safety engineering standards regarding maintenance and use of adequate safety systems.

For safety reasons, ABB draws your attention to the fact that only sufficiently insulated tools conforming to EN 60900 may be used.

Since the transmitter may form part of a safety chain, we recommend replacing the device immediately if any defects are detected. In case of use in Hazardous Area non sparking tools only must be employed.

In addition, you must observe the relevant safety regulations regarding the installation and operation of electrical systems, and the relevant standards, regulations and guidelines about explosion protection.

WARNING

The device can be operated at high levels of pressure and with aggressive process media. As a result, serious injury or significant property damage may occur if this device is operated incorrectly.

Improper use

It is prohibited to use the device for the following purposes:

- As a climbing aid, e.g., for mounting purposes.
- As a support for external loads, e.g., as a support for pipes.
- Adding material, e.g., by painting over the name plate or welding/soldering on parts.
- Removing material, e.g., by drilling the housing.

Repairs, alterations and enhancements, or the installation of replacement parts are only permissible as far as these are described in the manual. Approval by ABB must be requested for any activities beyond this scope. Repairs performed by ABB-authorized centers are excluded from this.

Technical limit values

The device is designed for use exclusively within the values stated on the name plates and within the technical limit values specified on the data sheets.

The following technical limit values must be observed:

- The Maximum Working Pressure may not be exceeded.
- The Maximum ambient operating temperature may not be exceeded.
- The Maximum process temperature may not be exceeded.
- The enclosure method of protection type must be observed.

Warranty provision

Using the device in a manner that does not fall within the scope of its intended use, disregarding this manual, using underqualified personnel, or making unauthorized alterations, releases the manufacturer from any liability for any resulting damage. This makes the manufacturer’s warranty null and void.

Use of instruction

DANGER

Serious damage to health/risk to life.

This message indicates that an imminent risk is present. Failure to avoid this will result in death or serious injury.

⚠ WARNING**Bodily injury.**

This message indicates a potentially dangerous situation. Failure to avoid this could result in death or serious injury.

⚠ CAUTION**Minor injuries.**

This message indicates a potentially dangerous situation. Failure to avoid this could result in minor injuries. This may also be used for property damage warnings.

IMPORTANT

This message indicates operator tips or particularly useful information. It does not indicate a dangerous or damaging situation.

NOTICE**Property damage.**

This message indicates a potentially damaging situation. Failure to avoid this could result in damage to the product or its surrounding area.

Operator liability

Prior to using corrosive and abrasive materials for measurement purposes, the operator must check the level of resistance of all parts coming into contact with the materials to be measured.

ABB will gladly support you in selecting the materials, but cannot accept any liability in doing so.

The operators must strictly observe the applicable national regulations with regard to installation, function tests, repairs, and maintenance of electrical devices.

Qualified personnel

Installation, commissioning, and maintenance of the device may only be performed by trained specialist personnel who have been authorized by the plant operator. The specialist personnel must have read and understood the manual and comply with its instructions.

Returning devices

Use the original packaging or suitably secure shipping package if you need to return the device for repair or recalibration purposes.

According to EU guidelines and other local laws for hazardous materials, the owner of hazardous waste is responsible for its disposal. The owner must observe the proper regulations for shipping purposes.

All devices sent back to ABB must be free from any hazardous materials (acids, alkalis, solvents, etc.).

Disposal

ABB actively promotes environmental awareness and has an operational management system that meets the requirements of ISO 9001:2015, ISO 14001:2015, and OHSAS 18001:2007.

Our products and solutions are intended to have minimum impact on the environment and persons during manufacturing, storage, transport, use and disposal.

This includes the environmentally friendly use of natural resources. ABB conducts an open dialog with the public through its publications.

This product/solution is manufactured from materials that can be reused by specialist recycling companies.

Information on WEEE Directive 2012/19/EU (Waste Electrical and Electronic Equipment)

This product or solution is subject to the WEEE Directive 2012/19/EU or corresponding national laws. Starting from August 15th 2018, electrical and electronic equipment marked with the crossed-out wheeled bin symbol may not be disposed as unsorted municipal waste. Waste of electrical and electronic equipment (WEEE) shall be treated separately using the national collection framework available to customers for the return, recycling and treatment of WEEE.

Proper disposal prevents negative effects on people and the environment, and supports the reuse of valuable raw materials. ABB can accept and dispose of returns for a fee.

Transport and storage

- After unpacking the pressure transmitter, check the device for transport damage.
- Check the packaging material for accessories.
- During intermediate storage or transport, store the pressure transmitter in the original packaging only.

For information on permissible ambient conditions for storage and transport, see chapter “4 Handling and storage” and product datasheet. Although there is no limit on the duration of storage, the warranty conditions stipulated on the order acknowledgment from the supplier still apply.

Safety information for electrical installation

Electrical connections may only be established by authorized specialist personnel in accordance with the electrical circuit diagrams. The electrical connection information in the manual must be observed; otherwise, the applicable protection type may be affected. Ground the measurement system according to requirements.

...1 Safety

Safety information for inspection and maintenance

WARNING - RISK TO PERSONS

There is no EMC protection or protection against accidental contact when the housing cover is open. There are electric circuits within the housing which are dangerous if touched. Therefore, the auxiliary power must be switched off before opening the housing cover.

WARNING - RISK TO PERSONS

The device can be operated at high pressure and with aggressive media. Any process media released may cause severe injuries. Depressurize the pipeline/tank before opening the transmitter connection.

Corrective maintenance work may only be performed by trained personnel.

- Before removing the device, depressurize it and any adjacent lines or containers.
- Check whether hazardous materials have been used as materials to be measured before opening the device.
- Residual amounts of hazardous substances may still be present in the device and could escape when the device is opened.

Within the scope of operator responsibility, check the following as part of a regular inspection:

- Pressure-bearing walls/lining of the pressure device
- Measurement-related function
- Leak-tightness
- Wear (corrosion)

Cyber security

Disclaimer

This product is designed to be connected to and to communicate information and data via a network interface. It is operator's sole responsibility to provide and continuously ensure a secure connection between the product and your network or any other network (as the case may be). Operator shall establish and maintain any appropriate measures (such as but not limited to the installation of firewalls, application of authentication measures, encryption of data, installation of anti-virus programs, etc) to protect the product, the network, its system and the interface against any kind of security breaches, unauthorized access, interference, intrusion, leakage and/or theft of data or information.

ABB and its affiliates are not liable for damages and/or losses related to such security breaches, any unauthorized access, interference, intrusion, leakage and/or theft of data or information.

Communication protocol specific

The HART protocol is an unsecured protocol, such as the intended application should be assessed to ensure that these protocols are suitable before implementation.

2 Transmitter overview

Transmitter components overview

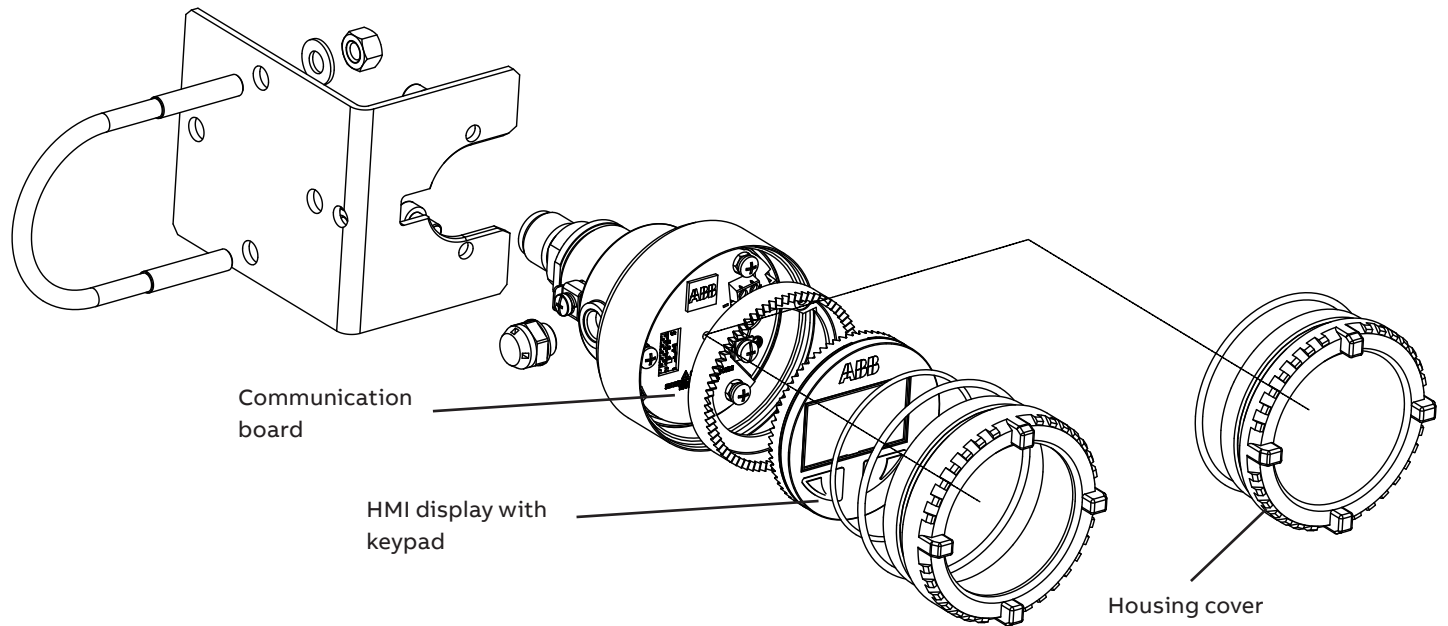

Figure 1 - Gauge / absolute pressure transmitter components

Range and span consideration

The PGS and PAS Transmitter data sheet provides all information concerning the Range and Span limits in relation to the model and the sensor code.

The terminology currently used to define the various parameters is as follows:

- URL: Upper Range Limit of a specific sensor. The highest value of the measured value that the transmitter can be adjusted to measure.
- LRL: Lower Range Limit of a specific sensor. The lowest value of the measured value that the transmitter can be adjusted to measure.
- URV: Upper Range Value. The highest value of the measured value to which the transmitter is calibrated.
- LRV: Lower Range Value. The lowest value of the measured value to which the transmitter is calibrated.
- SPAN: The algebraic difference between the Upper and Lower Range Values. The minimum span (MIN SPAN) is the minimum value that can be used without degradation of the specified performance. The calibration span (CAL SPAN) is the difference between Upper Range Value (URV) and Lower Range Value (LRV).
- TD: (or Turn Down Ratio) is the ratio between the maximum span and the calibrated span.

The transmitter can be calibrated with any range between the LRL and the URL with the following limitations:

- $LRL \leq LRV \leq (URL - CAL\ SPAN)$
- $CAL\ SPAN \geq MIN\ SPAN$
- $URV \leq URL$

3 Opening the box

Identification plates

The instrument is identified by the plates shown below.

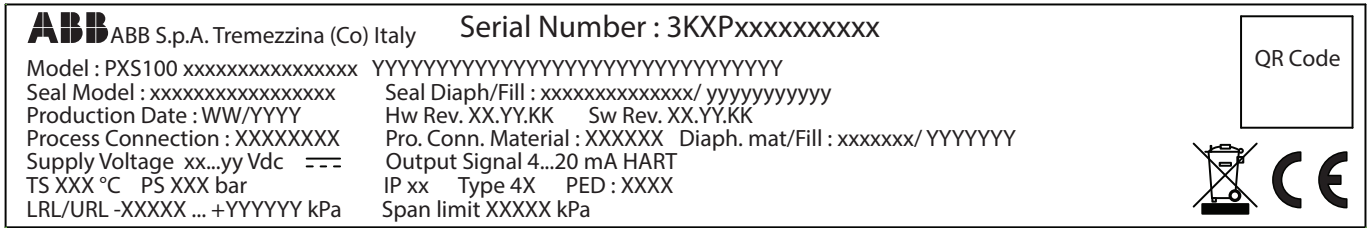

Figure 2 - Nameplate for pressure transmitter model PGSxxx/PASxxx

The plate in figure 2 provides detailed information associated with the transmitter, concerning the model code, date of production, hardware and software revisions, process wetted materials, power supply range, output signal, maximum working temperature (TS) and pressure (PS), IP rating, PED identification code, range and span limits, calibration range and special request number (if applicable) in another section.

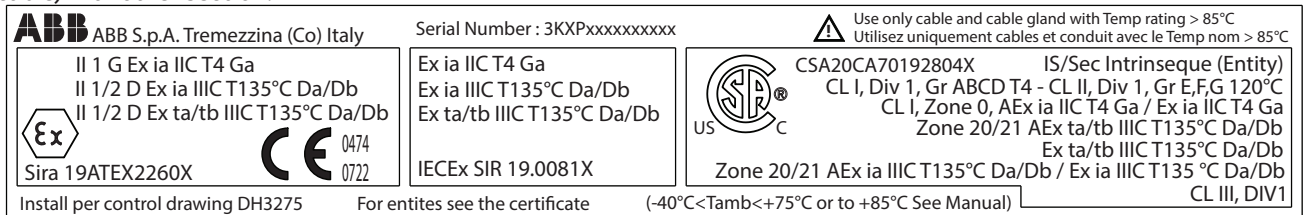

Figure 3 - Additional Ex plate for devices intended for use in explosion risk areas

The certification plate in figure 3 provides details relevant to the hazardous area application of the transmitter, including as applicable the markings and the relevant certificates, in association with the transmitter serial number and clear remarks to refer to specific concerned documentation.



Figure 4 - Tag plate for pressure transmitter model PGSxxx/PASxxx

The tag plate in figure 4 is dedicated for detailing the tag number, the calibrated span as upper and lower range values with associated engineering unit and the special request number, as applicable, if specified.

NOTICE

For information on the individual letters/numbers that make up the order code, please refer to the order confirmation or associated data sheet. For information about labeling in accordance with the Pressure Equipment Directive, please observe the information in “Compliance with Pressure Equipment Directive”.

The instrument may be used as a pressure accessory (category III) as defined by the Pressure Equipment Directive 2014/68/EU. In this case you will find the number of the notified body (0474) that have verified the compliance. PGS and PAS pressure transmitters are in compliance with EMC 2014/30/EU.

The certification plate is issued by ABB S.p.A, 22016 Tremezzina, Italy, with the numbers:

- Sira19ATEX2260X or IECEx SIR 19.0081X

CE-Identification number of the notified bodies to Pressure Equipment Directive: 0474, to ATEX certification: 0722, to IECEx certification: IT/CES/QAR07.0001.

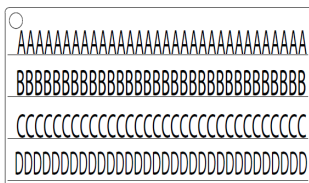

Figure 5 - 4-line layout of the optional wired-on Stainless Steel plate

Optional wired-on plate

Models PGS and PAS transmitter can be supplied with the optional “Wired On Stainless Steel plate” (figure 5) which is permanently laser printed with a custom text specified in phase of order. The available space consists in 4 lines with 32 characters per line. The plate will be connected to the transmitter with a Stainless Steel wire.

Handling and storage

The instrument does not require any special precautions during handling although normal good practice should be observed.

The instrument does not require any special treatment if stored as dispatched and within the specified ambient conditions.

There is no limit to the storage period, although the terms of guarantee remain as agreed with the Company and as given in the order acknowledgement.

4 Mounting

General

Study these installation instructions carefully before proceeding.

Failure to observe the warnings and instructions may cause a malfunction or personal hazard. Before installing the transmitter, check whether the device design meets the requirements of the measuring point from a measurement technology and safety point of view.

This applies in respect of the:

- Explosion protection certification
- Measuring range
- Gauge pressure stability
- Temperature (Ambient and Process)
- Operating voltage and current

The suitability of the materials must be checked as regards their resistance to the media. This applies in respect of the:

- Process connection, isolating diaphragm, etc.

In addition, the relevant directives, regulations, standards, and accident prevention regulations must be observed.

Measurement accuracy is largely dependent on correct installation of the pressure transmitter and, if applicable, the associated measuring pipe(s). As far as possible, the measuring setup should be free from critical ambient conditions such as large variations in temperature, vibrations, or shocks.

IMPORTANT

If unfavorable ambient conditions cannot be avoided for reasons relating to building structure, measurement technology, or other issues, the measurement quality may be affected. If a remote seal with capillary tube is installed on the transmitter, the additional operating instructions for remote seals and the related data sheets must be observed.

...4 Mounting

IP protection and designation

The housings for PGS and PAS transmitters are certified as conforming to protection type IP67 / IP68 / IP69K (according to ISO 20653) or NEMA 4X (according to NEMA 250).

The first number indicates the type of protection the integrated electronics have against the entry of foreign bodies, including dust.

“6” means that the housing is dust-proof (i.e., no ingress of dust).

The second number indicates the type of protection the housing has against the entry of water.

“7” means that the housing is protected against the effects of temporary immersion in water under standardized water pressure and temporal conditions.

“8” means that the housing is protected against the effects of continuous immersion in water under 2 m water pressure and 30 minutes temporal conditions.

“9K” means that the housing is protected against the effects of powerful high-temperature water jets under standardized water pressure, temperature and temporal conditions.

The device and its accessories (i.e. cable glands and other electrical connections) must be carefully and duly tightened to meet expected IP protection type.

When using/mounting cable glands, they have to meet expected IP rating.

Mounting the transmitter

Transmitter factory configuration consideration

The PGS and PAS pressure transmitter in your hands has been factory calibrated to reflect the published declared performance specification; no further calibration is required in normal condition. ABB typically configures PGS and PAS pressure transmitters according to the user requirements. A typical configuration includes:

- TAG number
- Calibrated span
- Output linearization
- LCD display configuration

Hazardous area considerations

The transmitter must be installed in hazardous area only if it is properly certified. The certification plate is permanently fixed on the housing of the transmitter. Transmitter can have the following certifications:

- **ATEX Europe (code HAM) approval**
- **IECEX (code HJM) approval**
- **Combined CSA (code HCM) approvals (US and Canada)**
- **Combined ATEX Europe, IECEX, CSA (US and Canada) approvals (code HMM)**

For installations according to Canada and US Approvals, see also control drawing DH3275.

See relevant paragraph for complete markings details.

Pressure Equipment Directive (PED) (2014/68/EU)

Devices with PS >200

Devices with a permissible pressure PS >200 bar have been subject to a conformity validation. The data label includes the following specifications: Pressure Equipment Directive (PED) (2014/68/EU).

Devices with PS ≤ 200

Devices with a permissible pressure PS ≤ 200 bar correspond to article 4 paragraph 3. They have not been subject to a conformity validation. These instruments were designed and manufactured according to SEP Sound Engineering Practices.

Mounting a P style pressure transmitter

A mounting bracket for wall or pipe mounting (2" pipe) is also available as an accessory.

Ideally, the pressure transmitter should be mounted in a vertical position to prevent subsequent zero shifts.

The pressure transmitter can also be mounted directly on the manifold.

IMPORTANT

If the transmitter is installed inclined with respect to the vertical, the filling liquid exerts hydrostatic pressure on the measuring diaphragm, resulting in a zero shift. In such an event, the zero point can be corrected via the zero push-button or via the "set PV to zero" command. Please refer to the [configuration section] for further details.

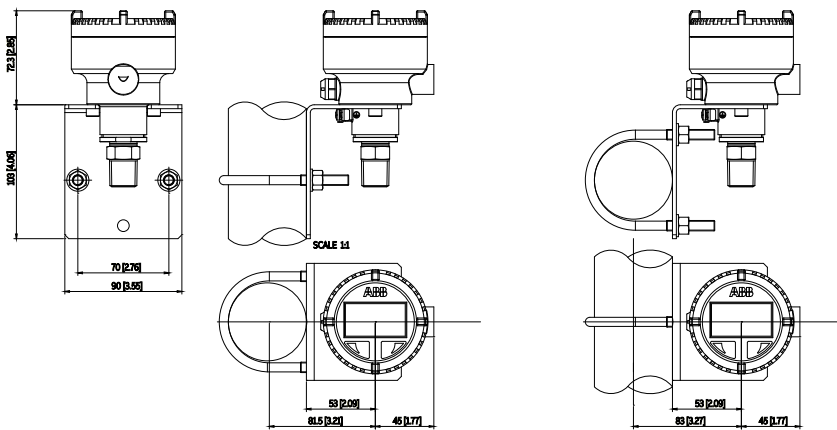

Figure 6 - Pipe and wall mounting bracket kits for P style transmitter

Sealing and screw connections

Connecting G ½ B spigot:

For sealing, a flat gasket must be used in accordance with DIN EN 837-1.

NPT threaded connection:

Seal the threads with PTFE or another approved resistant sealant.

Process connection with flush diaphragm:

Prior to mounting the device, install a welded connection or tapped hole according to relevant soldering standards (for process connection and welded connection dimensions, refer to data sheet).

Moisture

Use suitable cables and tighten cable glands securely. The transmitter can also be protected against the ingress of moisture by routing the connecting cable downward before securing it. This allows rain and condensation to drip down.

This is especially important for installation in outdoor areas and rooms that are exposed to moisture (e.g., due to cleaning processes) or on cooled or heated tanks.

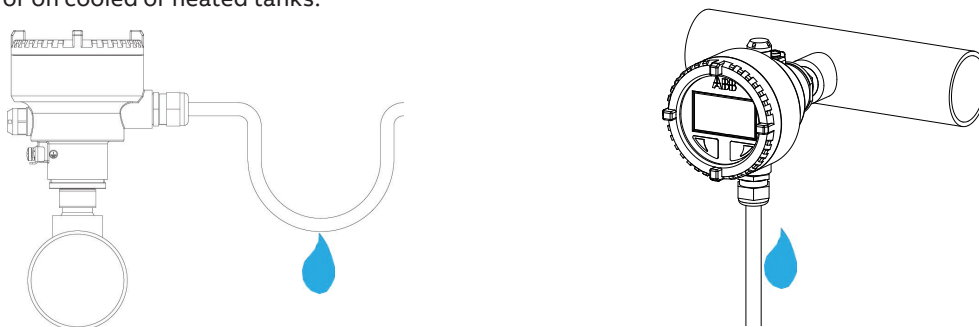

Figure 7 - Steps for preventing the ingress of moisture

...4 Mounting

Measuring pipe

In order for the pipes to be laid correctly, the following points must be observed:

- Keep the measuring pipe as short as possible and avoid sharp bends.
- Lay the measuring pipe in such a way that no deposits can accumulate in it. Gradients should not be less than approx. 8 % (ascending or descending).
- The measuring pipe should be blown through with compressed air or, better yet, flushed through with the measuring medium before connection.
- Completely depressurize the measuring pipe if the medium is a fluid.
- Lay the measuring pipe in such a way that gas bubbles (when measuring fluids) or condensate (when measuring gases) can flow back into the process line.
- When measuring steam, lay the measuring pipe in such a way that hot steam cannot flow back into the process connection (water trap, e.g., a water trap pipe that is filled with water before installation).
- Check the tightness of the connection.

5 Transmitter wiring

⚠ WARNING

General Risks.

Observe the applicable regulations governing electrical installation. Wiring must be executed in absence of power supply. Before installing the device, check that the existing operating voltage corresponds to the power supply limits indicated on the name plate.

Make sure to remove the power supply before connecting and/or disconnecting the device. High voltage that may be present on terminals can cause electrical shock.

Since the device has no overvoltage or lightning protection inside, the installer have to use external protection to increase the immunity level, if required.

Do NOT make electrical connections unless the electrical code designation stamped on the transmitter data plate agrees with the classification of the area in which the transmitter is to be installed.

Failure to comply with this warning can result in fire or explosion.

Supply requirement

For signal/power connection use twisted, stranded pairs of wiring no 18 to 22 AWG / 0.8 to 0.35mm² ø up to 5000 feet (1500 meters). Longer loops require larger wire.

If a shielded wire is used, the shield should be grounded only at one end, not both ends. In case of wiring at transmitter end, use the terminal located inside the housing marked with the appropriate sign.

The 4 to 20 mA dc output signal and the dc power supply to the transmitter are carried from the same pairs of wires.

The transmitter operates from 10.5 to 42 V DC with no load and is protected against reverse polarity connection.

For Ex ia and other intrinsically safe approval power supply must not exceed 30 V DC.

Minimum operating voltage increase to 14.5 V DC with optional backlight LCD display.

For maximum power supply voltage please refer to the identification plate of the transmitter.

The actual possible line length of the electrical circuit depends on the total capacitance and resistance, and can be estimated using the following formula:

$$L = \frac{65 \times 10^6}{R \times C} - \frac{C_f + 10000}{C}$$

Where:

L = Line length in m

R = Total line resistance in Ω (ohms)

C = Line capacitance in pF/m

C_f = Capacitance of the devices located in the circuit in pF

Avoid routing cables with other electrical cables (with inductive load, etc.) or near large electrical equipment.

Cable connection

Depending on the variant selected, the electrical connection port is a standard threaded M16 x 1.5 entry.

Alternative threads ½ in - 14 NPT or M20 x 1.5 through adapter can be selected in the ordering information.

The screw terminals are suitable for wiring cross-sections up to 1.5 mm² (16 AWG).

It is recommended that you strip approx. 30 to 35 mm (1.18 to 1.38 inch) off the cable jacket (see figure 8).

Use wiring rated 10 °C minimum above ambient temperature.

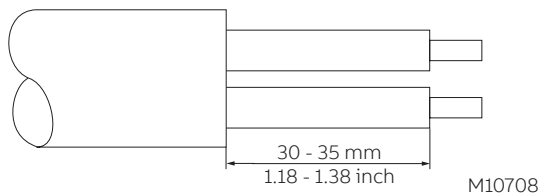

Figure 8 - Stripped connecting cable

IMPORTANT

Increased force will be required to unscrew the housing cover after an interval of several weeks. This is not caused by the threads, but instead is due solely to the type of gasket.

...5 Transmitter wiring

Wiring procedure

Follow these steps to wire the transmitter:

- Remove the temporary plastic cap from the electrical connection port of the transmitter housing.
- This connection port has an internal thread. Various adaptors and bushings can be fitted to these thread to comply with plant wiring (conduit) standards.
- Remove the housing cover. In an Explosion-Proof/Flame-Proof installation, do not remove the transmitter covers when power is applied to the unit.
- Run the cable through the cable gland and the open port.
- Connect the positive lead to the + terminal, and the negative lead to the – terminal.
- Plug and seal the electrical ports. Make sure that when the installation has been completed, the electrical ports are properly sealed against entry of rain and/or corrosive vapors and gases.

WARNING

General Risks.

Cable and cable gland must be in accordance with the intended type of protection (e.g. intrinsically safe) and degree of protection (e.g. IP6x according to IEC EN 60529 or NEMA 4x). See also the addendum for “EX SAFETY” ASPECTS AND “IP” PROTECTION.

- If applicable, install wiring with a drip loop. Arrange the drip loop so the bottom is lower than the conduit connections and the transmitter housing.
- Before reassembling cover, the integrity of the cover O-ring must be checked. If damaged it must be replaced with an original spare part. A slight grease layer should be applied for proper lubrication.
- Put back the housing cover, turn it to seat O-ring into the housing and then continue to hand tighten until the cover contacts the housing metal-to-metal. The cover must be closed with a 30/35 Nm tightening torque.

Grounding

Pressure transmitter housing should be grounded or earthed in accordance with national and local electrical codes.

Protective grounding terminals (PE) are available outside and/or inside the housing of the transmitter. If ordered, both ground terminals are electrically connected and it is up to the user to decide which one to use. The most effective transmitter case grounding method is a direct connection to earth ground with impedance equal to or less than 5 ohm.

...5 Transmitter wiring

Output (HART) transmitter wiring

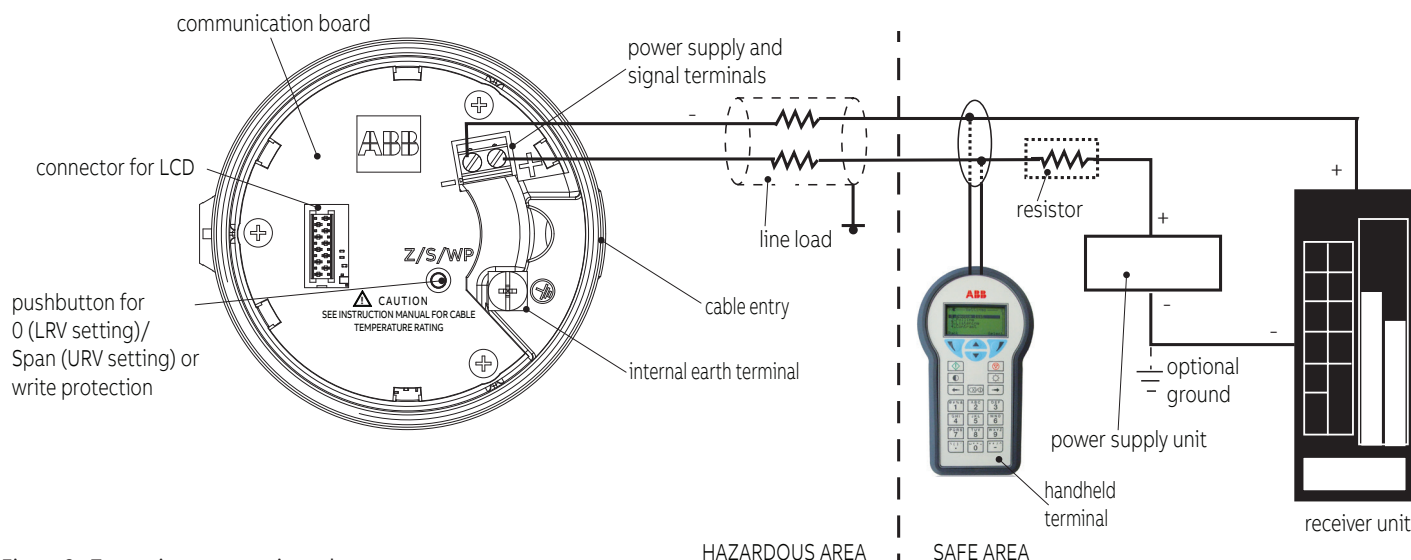

Figure 9 - Transmitter connection scheme

HART hand-held communicator may be connected at any wiring termination point in the loop, providing the minimum resistance is 250 ohm. If this is less than 250 ohm, additional resistance should be added to allow communications. The handheld terminal is connected between the resistor and transmitter, not between the resistor and power source.

| Application | Permissible voltage range of power supply | |
|---|--|--|
| | Standard | With optional backlit LCD display |
| Transmitter operated outside the potentially explosive atmosphere | from 10.5 to 42 V | from 14.5 to 42 V |
| Transmitter operated inside the potentially explosive atmosphere | from 10.5 to 30 V max (intrinsically safe) | from 14.5 to 30 V max (intrinsically safe) |

WARNING - RISK OF EXPLOSION

If, when using transmitters with type of protection “intrinsic safety”, an ammeter is connected to the output circuit or a modem is connected in parallel while there is a risk of explosion, the sums of the capacitances and inductances of all circuits, including the transmitter (see EC-type-examination certificate) must be equal to or less than the permissible capacitances and inductances of the intrinsically safe signal circuit (see EC-type-examination certificate for the power supply unit).

NOTICE

For CSA ordinary location, the maximum current must be limited to 150 mA by fuse (slow blow) or by a current limiter.

Communication setup

The transmitter can be operated via a HART modem, using a PC or laptop. The HART modem can be connected to the transmitter in parallel at any point in the signal circuit. Communication between transmitter and modem occurs via FSK signals that are superimposed on the analog 4 to 20 mA output signal. This modulation occurs without averaging, therefore does not affect the measuring signal.

Communication between transmitter and PC or laptop is only possible if the signal circuit is set up as shown in the following figure. The resistance between the connecting point for the FSK modem and the power supply must be at least 250 Ω (including internal resistance of the power supply unit). If this value is not achieved within the context of normal installation, an additional resistor must be used.

6 Commissioning

General remarks

Once the pressure transmitter has been installed, it is put into operation by switching on the operating voltage.

Check the following before switching on the operating voltage:

- Process connections
- Electrical connection
- Fill the impulse line and measuring chamber of the measuring cell completely with measuring medium.

The transmitter can then be put into operation.

To do this, the shut-off valves must be actuated in the following order (in the default setting, all valves are closed):

- 1 Open the discharge shut-off valve, if present.
- 2 Open the shut-off valve.

To put the transmitter out of operation, carry out the steps in reverse order.

NOTICE

In the case of pressure transmitters for absolute pressure and measuring ranges of ≤ 40 kPa absolute, please note that the pressure measuring cell has been overloaded over a long period by the atmospheric pressure during transport and storage. For this reason, you will need to allow a starting time of approx. 3 hours after commissioning until the sensor has stabilized to such an extent that the specified accuracy can be maintained.

When using transmitters with 'intrinsic safety' type of protection, if an ammeter is connected to the output circuit or a modem is connected in parallel while an explosion hazard is present, the sums of the capacitances and inductances of all circuits, including the transmitter (see EC type examination certificate) must be equal to or less than the permissible capacitances and inductances of the intrinsically safe signal circuit (see EC type examination certificate for the power supply unit).

Only passive or explosion-proof test devices or display instruments may be connected.

If the output signal stabilizes only slowly, it is likely that a large damping time constant has been set on the transmitter.

Output signal

If the applied pressure is within the values indicated on the name plate, the analog output current ranges between 4 and 20 mA.

If the pressure applied falls outside the set range, the output current will be driven as per defined configurations, as follows:

Output current limits for analog only version

Overload condition

Lower limit: 3.8 mA

Upper limit: 20.5 mA

Default alarm current: 21 mA

Output current limits for HART and analog version (according to NAMUR NE 43 standard)

Overload condition

Lower limit: 3.8 mA (settable from 3.8 to 4 mA)

Upper limit: 20.5 mA (settable from 20 to 21 mA)

Alarm current

Lower alarm value: 3.6 mA (settable from 3.6 to 4 mA)

High alarm value: 21 mA (settable from 20 to 22.8 mA)

Default setting: high alarm current

NAMUR NE 43 defines as alarm limits the lower ≤ 3.6 mA and the upper ≥ 21 mA.

Risk connected to any deviation from NAMUR NE43 thresholds of the alarm current limits falls under Customers' responsibility.

The graphical user interface (DD or FDI) can be used to diagnose the error.

NOTICE

A brief interruption in the power supply results in initialization of the electronics (program restarts).

Zero/Span and write protection

There is only one push button behind the display. It changes its function depending on the presence of the display.

When the display is installed, it works as hardware write protection switch. When the write protection is disabled, and it is kept pressed for some 1 second, then the write protection becomes enabled. In the opposite logic, when the write protection is enabled, and the button is kept pressed, then the write protection becomes disabled. This enable/disable condition can be observed/confirmed by looking at the lock symbol appearing or disappearing on the top line of the display.

Write protection prevents the configuration/modification of device data from being overwritten by unauthorized users. If write protection is enabled, both local and remote writings are refused. The Z (Zero) and S (Span) button cannot be used to set new range values because their writing is disabled while their use to enter and navigate into the local easy setup menu for the read/review of the device parameter setting is still allowed. However, when write protect is enabled, it is still possible to read out the configuration data using graphical user interface or communication tools (DD or FDI based).

Transmitter without display requires the communication tool to activate write protection.

Local display

Local display features a LCD dot matrix for clear visualizations.

Here after a possible view according to selected transmitter configuration:

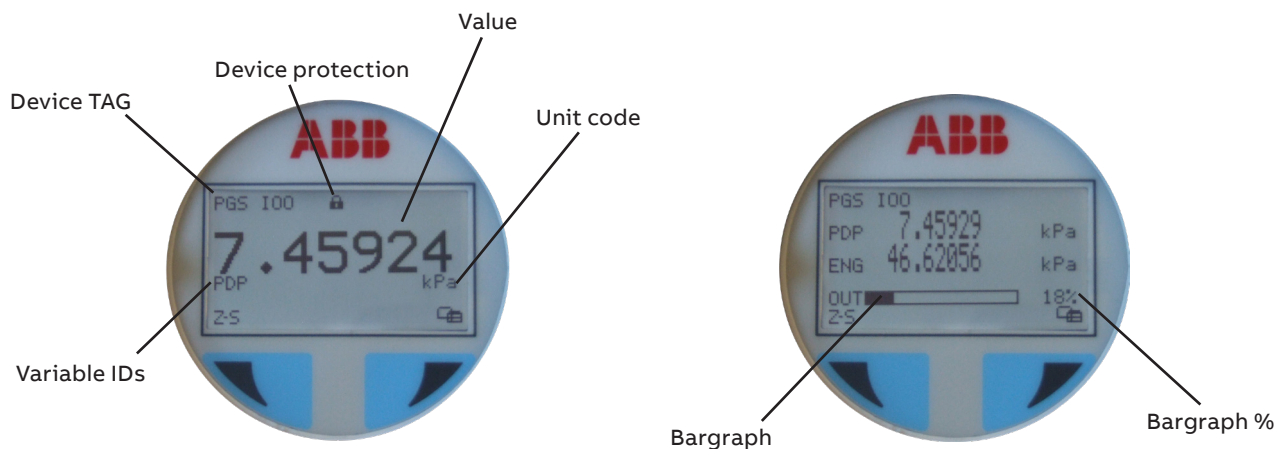

Row 1 displays:

- The HART short TAG, as a string of maximum 8 characters.
- The Lock symbol when either the local operation has been disabled or the device lock has been activated via relevant HART commands or the write protection is enabled. The write protection is enabled by the push button present on the electronics board and active only when LCD has been selected.

Row 2 is reserved to the value displayed with 5 digits, sign and decimal point, for one line visualization or with 8 digits, sign and decimal point, for two lines visualization.

Row 3 displays:

- The ID of Variables, is a kind of acronym which identifies the variable currently displayed, with following possibilities.
 - **PDP** Pressure value before transfer function/linearization
 - **ENG** Measured value after transfer function (scaled output)
 - **OUT** Analog current value in mA
 - **PV%** Analog output current in percentage of calibrated range
 - **ST** Sensor temperature
 - **HMI** Measured value after display scaling (HMI transfer function and scaling)
- The engineering unit code of the displayed measure. It can be anyone of HART list.

Row 4 displays:

- A bargraph additional to one-line or two-line value displayed that provides a different format of indication with relevant percentage for a selectable variable.

...6 Commissioning

Adjusting lower range value / oblique sensors

During installation of the transmitter, zero position shifts may occur due to the mounting position; these must be corrected. Possible cause includes the transmitter mounting position when different from recommended vertical mounting position.

NOTICE

The transmitter must have reached its operating temperature (approx. 5 min. after startup, if the transmitter has already reached the ambient temperature) in order to perform the zero shift correction.

There are two options (variant A or B) for calibrating the 4 to 20 mA output signal directly on the transmitter.

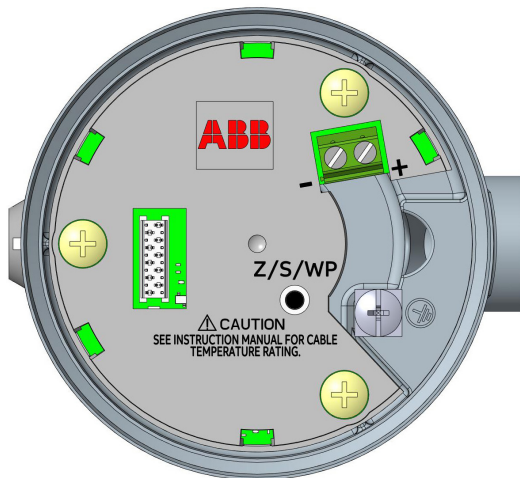

Variant A, without LCD option by using the pushbutton on the electronic board.

- 1 Make sure that the measured variable corresponds to the lower range value for the measurement process, i.e., that the pressure that the process exerts on the transmitter is the level of pressure required to generate a 4 mA output signal. The pressure must be stable (observe set damping level).
- 2 Unscrew the housing cover and press the pushbutton on the electronic unit (see the above figure) using a pin with diameter of ≤ 2.5 mm. Hold the pushbutton down for about 5/10 s. The output signal is set to 4 mA. The span remains unchanged.
- 3 Make sure that the measured variable corresponds to the upper range value for the measurement process, i.e., that the pressure that the process exerts on the transmitter is the level of pressure required to generate a 20 mA output signal. The pressure must be stable (observe set damping level).
- 4 Press the pushbutton on the electronic unit (see the above figure) using a pin with diameter of ≤ 2.5 mm. Hold the pushbutton down for at least 15/20 s. The output signal is set to 20 mA.
- 5 Screw the housing cover back on.

NOTICE

The procedure described in "A" above does not affect the physical pressure shown; it only corrects the analog output signal. For this reason, the analog output signal may differ from the physical pressure shown on the digital display or the communication tool.

To avoid this discrepancy, you need to correct the zero position shift (zero shift) as described under variant "B".

Variant B, with touchscreen controls on the optional LCD display.

For PGS100/PAS100 models, when in operating mode, the device shows respectively "Z-S" on the left and configuration menu icon on the right side of the display. Pressing left button for approx. 3 s leads to the sub-menu for Zero and Span, showing letters Z and S respectively in the left and right bottom corners.

- 1 Press the Z button for less than 5 s, on the display appears the text "Do you want to proceed with Zero?" and the two buttons change their meaning to Yes / No.
- 2 Pressing No, the "Zero" operation is aborted, while pressing Yes the "Zero" operation is confirmed/accepted and executed.
- 3 The "Zero" operation executed with this modality set the "Lower Range Value" with the pressure value measured in that instant while the "Upper Range Value" is shifted of the same quantity maintaining the "Span", as difference between the Lower and Upper Range values, same as before of the "Zero" operation.
- 4 As soon as the Yes button is pressed, and the operation executed, in the bottom line of the display it appears for 5 s a message relating the result of the operation.
- 5 In case of success it appears "Oper Done", otherwise, it is displayed one message describing the reason for failure.
- 6 Likewise, when you press the S button for less than 5 s, on the display appears the text "Do you want to proceed with Span?" and the two buttons change their meaning to Yes / No.
- 7 Pressing No, the "Span" operation is aborted, while pressing Yes the "Span" operation is confirmed/accepted and executed, displaying a feed-back of the result in the bottom line of the display.
- 8 The "Span" operation executed with this modality set the "Upper Range Value" with the pressure value measured in that instant while the "Lower Range Value" is not changed.
- 9 With this operation the "Span" value is changed.

Installing/Removing the LCD display



The LCD display is attached to the electronic board of the pressure transmitter. The LCD display can be replaced, e.g., if defective.

WARNING - RISK OF BURNS

The connection head can become very hot as a result of the process. There is a danger of burns. Power off the transmitter before replacing the LCD display. The transmitter atmosphere may be explosive. Risk of explosion!

- 1 Unscrew the housing cover of the transmitter.
- 2 For replacement carefully remove the LCD display from the inset connector of the transmitter. The LCD display just stay in position on the electronic board and is firmly kept by properly screwing the housing cover. Take care to avoid any damage when removing the cover, due to possible detaching of the LCD which can also cause the flat cable extension.
- 3 The length of the flat cable allows to carry out the wiring connection to the terminals without disconnecting the LCD display.
- 4 No tools are required to insert the LCD connector of the replacement display. Carefully insert without forcing to avoid wrong positioning and make sure the black connector of the flat fits into the connector on the electronic board, as shown in the following photo.
- 5 Make sure that the connector is fully inserted.



IMPORTANT

Carefully insert the flat connector following the required polarity.

Following this, the position of the LCD display can be adjusted to suit the installation position of the transmitter, to ensure that the display is legible.

The LCD display can be rotated with increments of 5°.

IMPORTANT

Make sure the flat ribbon cable does not get twisted or torn when rotating the LCD display.

IMPORTANT

Take care not to pinch the flat ribbon cable when rotating the LCD display.

- 6 Screw on the housing cover for the transmitter.

IMPORTANT

Gently push the LCD display to ensure its positioning as needed, while tightening the housing cover.



...6 Commissioning

Pressure sensor ventilation (PGS100 only)

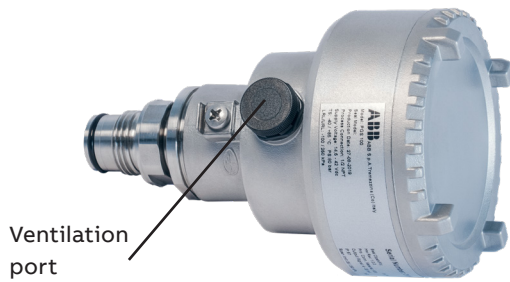

Transmitter has a reference port vented to the atmosphere and duly protected. Care must be taken to avoid obstruction of the port (i.e. covered, dirty) as it can affect the measurement.

7 Operation (only HART version)

LCD display

For PGS100/PAS100 models, when in operating mode, the device shows respectively “Z-S” on the left and configuration menu icon on the right side of the display. Pressing left button for approximately 3 s leads to the sub-menu for Zero and Span, showing letters Z and S respectively in the left and right bottom corners.

Zero trim can be performed by pressing the left button again. A confirmation to proceed is subsequently requested by pushing on the opposite button.

With the same logic but pressing the right button in the Z-S sub-menu page, user can perform Span adjustment. A confirmation to proceed is subsequently requested also for Span.

In order to access the sub-menu for configuration and diagnostic, press the right button for approximately 3 s from operating mode view.

Press then for 2 s the right button to access the menu or press the left button to access signals view or diagnostic messages. Without action on buttons associated to bottom icons after few seconds the transmitter returns to normal display view.



Local diagnostic menu

From the operating mode view, press the right button for approx. 3 s, then pushing the left button, the display enters in the local diagnostic menu displaying the status and device health.

When no errors are active, it appears the string “All Alarms Clear”.

When one or more error conditions are active at the same time, on the left side it is displayed the NAMUR Classification icon of the most severe condition while, in the right side, is displayed the error code plus a short textual description and a brief suggested action about how it could be fixed.

The error code is the combination of the letter relating its NAMUR NE107 classification (F, M, S, C) assigned by the manufacturer at each individual error, plus its internal priority number and a three digits code.



If more errors are active together, they are displayed into this page according to their priority. They can be visualized by scrolling down the screen with the left button assuming the function of “Next” and their order is indicated by the bar and number on the right side of the display.

LCD menu structure

PGS100/PAS100 models feature only the Easy Setup menu in a dedicated structure, different from other HART versions. Once accessed the menu should be completed until the last step is reached, then to return to the normal display view. For each step follow the instructions on the screen and consider that for alfa/numeric parameters it is required to move digit by digit until the right bottom corner display OK. Pressing the right on-board button or the external S pushbutton the operation is confirmed, while pressing the left on-board button or the external Z pushbutton the display change to CANCEL to abort the operation by the associated button (right/S).

IMPORTANT

After 50 seconds without action on on-board buttons, the transmitter automatically exits the configuration menu.

Follow the instruction on the screen to perform the configuration of the different parameters.

This menu allows the verification and the parameterization of the basic configuration of the PGS100/PAS100 pressure transmitter. The menu driven structure will guide you to the choice of the interface language, the tag number, the engineering units, the LRV and URV (lower range value and upper range value), the transfer function (linear or square root), the damping time, the display visualization mode (the values that need to be visualized on the LCD), the auto set zero (set the input measured value to 4 mA and the PV value to 0), the RESET PV bias (removes any previously configured bias values), the contrast.

...7 Operation



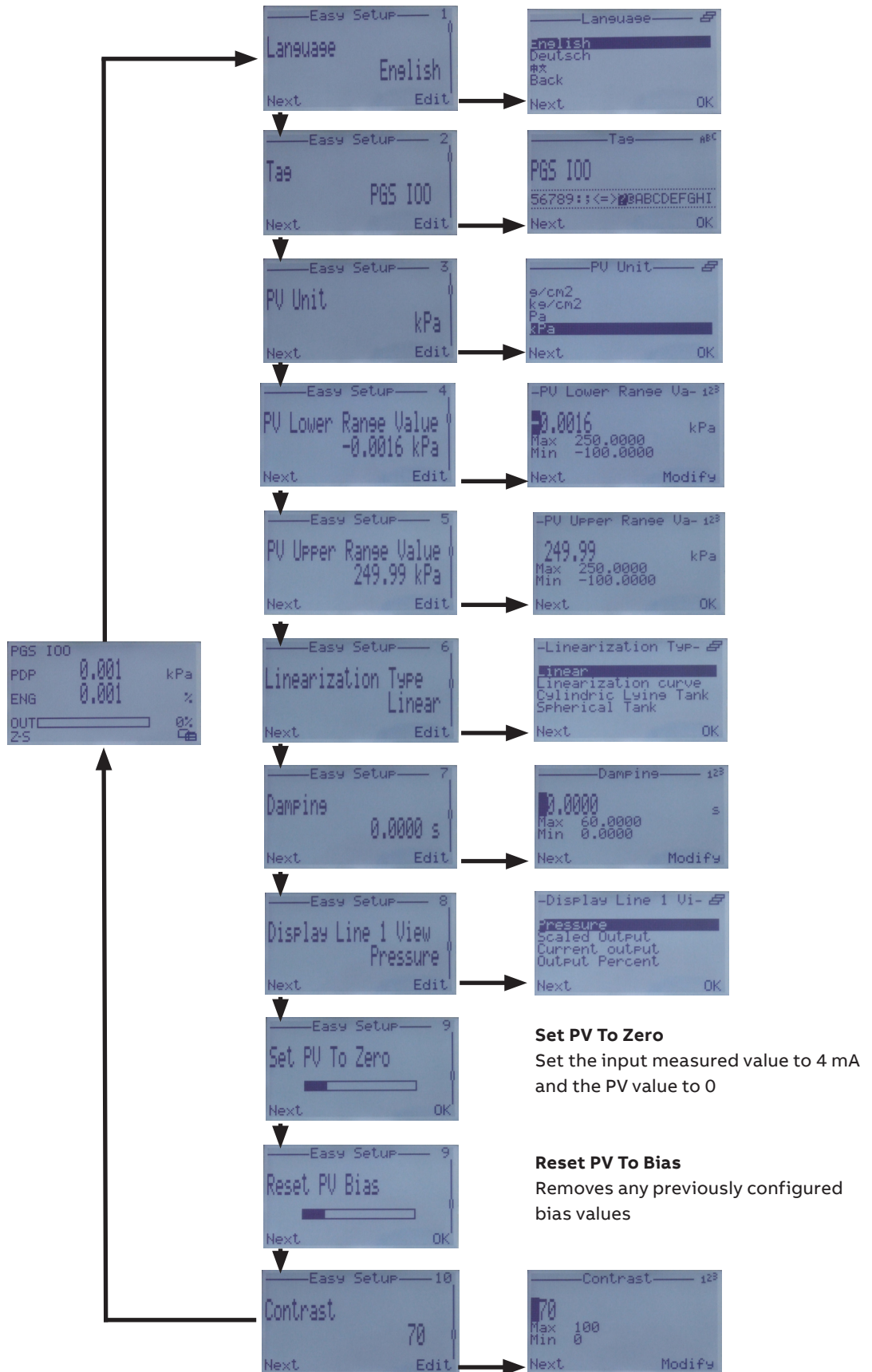

Easy setup menu



8 Error messages

LCD display messages

The LCD HMI in case of transmitter errors or malfunctioning is capable of displaying specific error/fault messages to help the user in identifying the problem and resolve it. In case of an alarm, a message consisting of an icon and text appears at the bottom of the process display, as shown hereafter.

| Icon | Description |
|--|--|
|  | Error / Failure |
|  | Functional check (e.g. during simulation) |
|  | Out of Spec (e.g. operating with empty meter pipe) |
|  | Maintenance required |

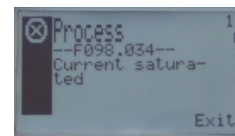
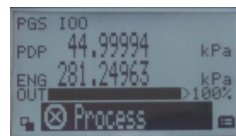

In the error description, the error number is displayed in the second line (F098.034). Two further lines are used to describe the error. The device status is divided into four groups. The message text beside this icon in the display provides information about where to look for the error. There are the following areas: **Electronic, Sensor, Configuration, Operating and Process**.

Error states and alarms

| HMI - NAMUR Code | Code | Error | Description | Possible cause | Suggested action | Tx Response |
|------------------|---------|----------------------------|---|--|--|------------------------|
| F | 116.023 | Electronic memory failure | The device data loaded at the start up from the electronics NV-memory are corrupted precluding the correct functionality of the device. During the start-up the device firmware execute a check of the device database and if the CRC doesn't match what expected the firmware stops its execution and the output signal goes to fail safe value. | EMC problems like electrostatic discharge (ESD), burst, surge outside the specification limits and/or soft errors (ionic radiation) could corrupt memory data. | The device must be replaced or the database must be reloaded. | Analog signal to alarm |
| F | 108.040 | Output read-back failure | The reading of the 4-20mA output signal is too different from what should have been generated. | The output circuit could be broken or not correctly calibrated. | A DAC (digital to output converter) trimming should be performed and if the error persists consider to replace the device. | Analog signal to alarm |
| F | 118.017 | Sensor memory failure | "The data in the sensor memory are corrupted precluding the correct functionality of the device. During the start-up the device firmware execute a check of the device data-base and if the calculated CRC doesn't match what expected the firmware stops its execution and the output signal goes to fail safe value." | "The Sensor data/coefficients in the sensor memory are corrupted precluding the correct functionality of the device" | The device must be replaced | Analog signal to alarm |
| F | 114.000 | P-dP sensor failure | The sensor signal value is missing or incorrect due to a mechanical failure. | There could be a bad or broken connection between sensor and electronics and/or a mechanical damage of the sensor not generating anymore valid primary signals. Loss of fill fluid from the cell, ruptured diaphragm, other. | The device must be replaced | Analog signal to alarm |
| F | 110.002 | Sensor temperature failure | The measurement accuracy is decreased. The current process value is compensated with the last valid value of the Sensor temperature. | The circuitry for the sampling of the temperature has failed. | The device must be replaced | Analog signal to alarm |

...8 Error messages

...Error states and alarms

| HMI - NAMUR Code | Code | Error | Description | Possible cause | Suggested action | Tx Response |
|------------------|---------|----------------------------------|--|---|--|-------------|
| F | 102.004 | P-dP out of limits | The measured Pressure value is outside the sensor limits and no longer representing the true applied pressure value. | The measurement range has not been correctly calculated OR an incorrect transducer model has been selected. | The compatibility of pressure transmitter model and process conditions has to be checked. Probably a different transmitter type is required. | No effect |
| F | 098.034 | Analog output saturated | The analog output (4 to 20 mA) is frozen to one of its Saturation limits between High or Low and no longer represents the true applied process. This is not a device error, but it is consequence of its configured working range in relation to the dynamic of the process measurement. | The applied/measured pressure is beyond the configured working range represented by the Low and High range values. | Use a HART configurator (DD handheld) in order to: 1. Recognize in detail at which limit (high or low) the analog output is Saturated 2. Adjust the Saturation Limit or the working range if possible. | No effect |
| S | 054.006 | Sensor temperature out of limits | The sensor temperature is outside its operational limits as specified in the product data-sheet. This is not a device issue but if its sensor is subject to work at abnormal temperature conditions for long time, then the device components could degrade affecting its accuracy and reliability. | The temperature of the process environment affects the pressure transmitter; In some situation, the device installation could be the cause of a sensor overheating. | The compatibility of pressure transmitter model and process conditions has to be checked. It could be required to perform a new sensor trimming or device replacement. A different installation type could be also considered/ required e.g. use of remote seals. | No effect |
| S | 052.031 | Max working pressure exceeded | The measured process pressure is higher than the acceptable mechanical limit of the process connection elements. When this condition occurs, there is the risk to damage the transmitter and to be dangerous for the personnel. | The selected transmitter and/or the process connection elements are not adequate for the specific process conditions. | The compatibility of the pressure transmitter model with process conditions must be checked and, if necessary, replace the instrument with another having the correct characteristics. | No effect |
| C | 090.033 | Loop test | The 4 to 20 mA signal in output by the transmitter is simulated by the user and no longer represents the true applied process. | The operator could have enabled the loop test function in order to simulate the current output for testing purposes but, at the end, forgot to return it back to normal condition disabling the loop test function. | Use a HART configurator (DD handheld) to place device back into normal operating mode (disable the analog output simulation). | No effect |
| C | 080.030 | Input simulation active | At least one of the following variables produced by the transmitter is simulated and doesn't represent the real calculated value: 1. the pressure value 2. the Sensor temperature value 3. the Scaled output value. | The operator could have enabled the input simulation of one or more device variables for testing purposes but, at the end, forgot to return it back to normal condition disabling the input simulation condition. | Use a HART configurator (DD handheld) in order to: 1. recognize in detail which variable is under simulation condition 2. place device back into normal operating mode (disable the input simulation). Otherwise just power off/on the device in order to disable the input simulation. | No effect |

| HMI - NAMUR Code | Code | Error | Description | Possible cause | Suggested action | Tx Response |
|------------------|---------|---------------------------------------|--|--|---|-------------|
| M | xxx.003 | Electronics temperature failure | The measurement accuracy could be decreased because the digital to analog converter (DAC) remains compensated with the last valid value of the electronic temperature. | The circuitry for the sampling of the electronics temperature has failed. | The device should be replaced as soon as possible. | No effect |
| M | 026.024 | Electronics NV-memory burn error | Permanent storing of modified data into the electronic Non-Volatile memory has not been successfully executed. The device continues to work without problems but, after the next power cycle there is the risk to lose the last used device setting/configuration. | <ul style="list-style-type: none"> The device could have been powered off immediately after the modification of the data that was not fully written in the NV-memory. The NV-memory has reached its limit of maximum number of allowed writings Generic defect of the memory component. | The device should be replaced as soon as possible. | No effect |
| M | 028.018 | Sensor NV-Memory burn error | Permanent storing of modified data into the Sensor Non-Volatile memory has not been successfully executed. The device continues to work without problems but, after the next power cycle there is the risk to lose the last used device setting/configuration. | <ul style="list-style-type: none"> The device could have been powered off immediately after the modification of the data that was not fully written in the NV-memory. The NV memory has reached its limit of maximum number of allowed writings Generic defect of the memory component | Retry to write the same configuration values but, if the error persists, consider to replace the device as soon as possible | No effect |
| M | 024.036 | Power supply warning | The device power supply has been detected too close to its higher or lower acceptable limits. | If the power supply is close to the highest limit very probably it is due to a not correct external power supply while if the power supply is close to the lowest limit, it could be due to a defective or not adequate external power supply or anomalous voltage drop on the loop i.e. too long or not correct wires. | Check the voltage at the terminal block and if it is not within the valid range check the external power supply or the loop. | No effect |
| M | 022.041 | Electronics temperature out of limits | The electronics temperature is working beyond its High or Low specification limits. | This condition could be due to the circuitry for the sampling of the temperature that has failed or due to the transmitter installation e.g. steam leakage directed on to transmitter housing, or critical ambiental conditions. | <p>If necessary, use a HART configurator in order to know in detail of which limit (high or low) the electronics temperature is beyond.</p> <p>Check the transmitter installation to identify possible cause of the abnormal measured temperature and take possible actions to minimize the temperature impact/influence like to insulate the device from the external temperature influence.</p> | No effect |

...8 Error messages

QR code Digital Advanced Diagnostic (DAD)

Digital Advanced Diagnostic (DAD) QR Code is an option (only available with the backlight display), which allows the user to retrieve information about device status directly in the field.

With DAD option activated and in presence of a failure / malfunction, the device will alternatively show the operator page with the standard diagnostic message and a QR code that user can scan using any QR code reader.



By scanning the QR code, user will have access to a specific .pdf format document indicating the suggested action to be taken to resolve the failure / malfunctioning.

Access to document can happen directly or via clicking on a link depending on the QR code reader setting, which is independent from ABB devices.

In the same Digital Advanced Diagnostic document it is as well available the full list of error codes that can be resolved with the suggested action.

Leveraging the .pdf document with the error list on the device (i.e. mobile or tablet) and by accessing the diagnostic section on the device, user can exactly retrieve the effective cause of the failure / malfunction and react properly.

Digital Advanced Diagnostic is very helpful in the field to have immediate access to information previously unavailable in the field in a fast and digital way.

QR code Channel Partner Support

Channel Partner Support QR Code is instead an option that allows ABB channel partners to provide more information to customer by loading a series of data like physical and/or mail address, phone number, etc directly on the device.

The Channel Partner Support QR Code is part of the personalization option set available at ABB channel partners. Using the above, customer can always have on hand and directly in the field an immediate contact point for assistance and support.

9 Maintenance / Repair

If transmitters are used as intended under normal operating conditions, no maintenance is required. It is sufficient to check the output signal at regular intervals (in accordance with the operating conditions). If deposits are expected to accumulate, the equipment should be cleaned on a regular basis, in accordance with the operating conditions.

Cleaning should ideally be carried out in a workshop.

Repair and maintenance activities may only be performed by authorized customer service personnel.

PxS100 user repair is not permitted.

When replacing or repairing individual components, original spare parts must be used.

⚠ WARNING - BODILY INJURY

The device can be operated at high pressure and with aggressive media. Any medium that spurts out can cause severe injuries.

Depressurize the pipeline/tank before opening the transmitter connection.

IMPORTANT

Potential damage to device as a result of electrostatic charging!

When the housing is open, EMC protection is impaired and there is no longer any protection against accidental contact. The electronic components of the printed circuit board can be damaged by static electricity. Do not touch conductive parts of the device or use adequate ESD protections.

Make sure that the static electricity in your body is discharged when touching electronic components. If a remote seal is mounted on the measuring equipment, it must not be removed (please refer to the dedicated document).

⚠ WARNING - BODILY INJURY

Transmitters certified for hazardous area must be either repaired by the manufacturer or approved by a certified expert following repair work. Observe the relevant safety precautions before, during and after repair work. Only disassemble the transmitter to the extent necessary for cleaning, inspection, repairs and replacement of damaged components.

IMPORTANT

The use of non original spare parts makes the warranty void.

Check whether hazardous materials have been used as materials to be measured before opening the device. Residual amounts of hazardous material may still be present in the device and could escape when it is opened.

Within the scope of operator responsibility, check the following as part of a regular inspection:

- the pressure-carrying walls / lining of the pressure device
- the measurement-related function
- the leak tightness
- the wear (corrosion)

PGS100 transmitter has a reference port vented to the atmosphere and duly protected (see picture). During maintenance check that this port is free from dirt, deposits, anything that can obstruct it, as this can affect the measurement performance.



Returns and removal

Defective transmitters sent to the repairs department must, wherever possible, be accompanied by your own description of the fault and its underlying cause.

⚠ WARNING

Potential danger if device is disassembled incorrectly! Before removing or disassembling the device, check for hazardous process conditions such as pressure on the device, high temperatures, aggressive or toxic media, and so on. Carefully read the instructions in the 'Safety', 'Mounting', and 'Electrical connections' chapters, and perform the specified steps in reverse order.

10 Hazardous Area considerations

Specific conditions of use (X)

The SIL2 version is identified by option code NL (i.e. PXS100XXXXXX...NL). It is not capable of withstanding a 500 V r.m.s. dielectric strength test according to Clause 6.3.13 of IEC 60079-11:2011.

This shall be taken into account in any equipment installation. When the PGS100/PAS100 pressure transmitter is used for group III Db, do not install in area that is subject to flowing dust.

Explosion protection

Explosion-protection should be conducted in accordance with Directive 2014/34/EU (ATEX). When installing certified transmitters (electrical connection, grounding / potential equalization, etc.), observe national regulations, explosion-protection directives and standards. The certified method of protection for the transmitter is provided on the Ex plate.

Type-examination certificate/Declaration of conformity

For transmitters with hazardous location design, the EU declaration of conformity and this operating instruction should be complied with. The EU type examination certificates to be applied are available for download online on the ABB website.

Type of protection “intrinsic safety Ex ia”

Only intrinsically safe devices may be installed in the transmitter signal circuit. The signal circuit can be interrupted while the transmitter is in operation (e.g., clamping/ unclamping signal lines).

The housing may be opened during operation, in absence of explosive atmosphere.

Transmitters with and without remote seals and featuring type of protection “intrinsic safety Ex ia” may be directly integrated into the partition separating application for gas Zone 0 and Zone 1 (sensor diaphragm in Zone 0, transmitter in Zone 1), and application for dust Zone 20 and Zone 21 (sensor diaphragm in Zone 20, transmitter in Zone 21), provided that the power is supplied via an intrinsically safe circuit with type of protection “Ex ia”.

Use in areas with combustible dust

Installation should be performed in accordance with the EN 60079-14 installation regulations.

The transmitter should only be connected using cable glands certified in accordance with Directive 2014/34/EU (ATEX). The cable gland must conform to IP rating IP 67.

The smoldering temperature of the dust must be at least 75 K above the maximum surface temperature of the transmitter. The maximum surface temperature is 120 °C (248 °F) or T135 °C.

WARNING - RISK OF EXPLOSION

When using remote seals with an anti-stick coating, be aware of the risk of electrostatic discharge (with consideration given to the filling material and transport speed).

WARNING - RISK OF EXPLOSION

Opening the housing during operation (with the supply voltage switched on) is not permitted. Opening the cover presents a risk of spark formation and, therefore, explosion. Only open the housing when the supply voltage is switched off).

Use of handheld terminal / PC

If a handheld terminal or a PC is being used for communication / configuration / parameterization in a potentially explosive atmosphere with type of protection “intrinsic safety”, the devices used must be certified accordingly. This applies even if the device is only connected for a short period of time. This proof of “intrinsic safety” must be supplied in addition to the transmitter.

Hazardous atmospheres

ATEX transmitter with the following types of protection: “intrinsic safety Ex ia” and “dust ignition protection by enclosure Ex ta/tb” in accordance with Directive 2014/34/EU

| Transmitter with 4 to 20 mA output signal and HART communication | |
|--|---|
| Certificate no. | Sira19ATEX2260X |
| Marking for transmitter without HMI | II 1 G Ex ia IIC T4 Ga II 1/2 D Ex ia IIIC T 135°C Da/Db II 1/2 D Ex ta/tb IIIC T 135°C Da/Db |
| Marking for transmitter with HMI | II 1 G Ex ia IIC T4 Ga |

| Permissible ambient temperature versus process temperature / class | | |
|--|---------------------|--------------------------|
| Type of protection | Process temperature | Max. ambient temperature |
| Application without HMI Ex ia IIC T4 | ≤ 120° C | 85° C |
| Ex ia IIIC T 135° C | ≤ 85° C | 85° C |
| | > 85° C ≤ 120° C | 75° C |
| Application with HMI Ex ia IIC T4 | ≤ 120° C | 85° C |

| Power supply and signal circuit with “intrinsic safety Ex ia” type of protection, with the following maximum values | |
|---|-------------------------|
| | U _i = 30 V |
| | I _i = 100 mA |
| | P _i = 1 W |
| Effective internal capacitance | C _i = 3.7 nF |
| Effective internal inductance | L _i = 0 μH |

IECEx transmitter with the following types of protection: “intrinsic safety Ex ia” and “dust ignition protection by enclosure Ex ta/tb” in accordance with IEC standards

| Transmitter with 4 to 20 mA output signal and HART communication | |
|--|--|
| Certificate no. | IECEx SIR 19.0081X |
| Marking for transmitter without HMI | Ex ia IIC T4 Ga Ex ia IIIC T 135°C Da/Db Ex ta/tb IIIC T 135°C Da/Db |
| Marking for transmitter with HMI | Ex ia IIC T4 Ga |

| Permissible ambient temperature versus process temperature / class | | |
|--|---------------------|--------------------------|
| Type of protection | Process temperature | Max. ambient temperature |
| Application without HMI Ex ia IIC T4 | ≤ 120° C | 85° C |
| Ex ia IIIC T 135° C | ≤ 85° C | 85° C |
| | > 85° C ≤ 120° C | 75° C |
| Application with HMI Ex ia IIC T4 | ≤ 120° C | 85° C |

| Power supply and signal circuit with “intrinsic safety Ex ia” type of protection, with the following maximum values | |
|---|-------------------------|
| | U _i = 30 V |
| | I _i = 100 mA |
| | P _i = 1 W |
| Effective internal capacitance | C _i = 3.7 nF |
| Effective internal inductance | L _i = 0 μH |

...10 Hazardous Area considerations

Conditions of Acceptability

The SIL2 version of the Pressure Transmitter, which is identified by 'NL' being included model designation, is not capable of passing a 500V r.m.s. dielectric strength test in accordance Clause 10.3 of ANSI/ISA 60079-11 (12.02.01)-2012 – ANSI/UL 60079-11 Sixth Edition and CAN/CSA-C22.2 No. 60079-11:14 between its Intrinsically Safe circuits and its enclosure. This shall be considered in any equipment intrinsic safety installation.

When the Pressure Transmitter is used in a Group III Db Hazardous Area it shall be installed such that it is not subjected to flowing dust.

For Group III installations the Pressure Transmitter shall be fitted with a hazardous location approved cable entry device.

For Group III Ex tb installations this device shall provide ingress protection of at least IP 6X.

For Group III Ex ia installations this device shall provide ingress protection of at least IP 5X.t.

Canadian Standards Association (US)

| Transmitter with 4 to 20 mA output signal and HART communication | |
|--|---|
| Marking for transmitter without HMI | Class I, Zone 0, AEx ia IIC T4 Ga IS Class I Div 1 Gr A, B, C, D T4 IS Class II, Div 1 Gr E, F, G 120° C Zone 20/21 AEx ia IIIC T135° C Da/Db Zone 20/21 AEx ta/tb IIIC T135° C Da/Db Class III, Div 1 |
| Marking for transmitter with HMI | Class I, Zone 0, AEx ia IIC T4 Ga Class I Div 1 Gr A, B, C, D T4 |
| Degree of protection | NEMA type 4X (indoor and outdoor installation) |

Canadian Standards Association (Canada)

| Transmitter with 4 to 20 mA output signal and HART communication | |
|--|---|
| Marking for transmitter without HMI | Ex ia IIC T4 Ga IS Class I Div 1 Gr A, B, C, D T4 IS Class II, Div 1 Gr E, F, G 120° C Ex ia IIIC T135°C Da/Db Ex ta/tb IIIC T135°C Da/Db Class III, Div 1 |
| Marking for transmitter with HMI | Ex ia IIC T4 Ga Class I Div 1 Gr A, B, C, D T4 |
| Degree of protection | NEMA type 4X (indoor and outdoor installation) |

| Permissible ambient temperature versus process temperature / class | | |
|--|---------------------|--------------------------|
| Type of protection | Process temperature | Max. ambient temperature |
| Application without HMI | | |
| Ex ia IIC T4 | ≤ 120° C | 85° C |
| Class I, Zone 0, AEx ia IIC T4 | | |
| Class I Div 1 Gr A, B, C, D T4 | | |
| Ex ia IIIC T 135° C | ≤ 85° C | 85° C |
| Zone 20/21 AEx ia IIIC T135° C | > 85° C ≤ 120° C | 75° C |
| Class II, Div 1 Gr E, F, G 120° C | | |
| Application with HMI | | |
| Ex ia IIC T4 | ≤ 120° C | 85° C |
| Class I Div 1 Gr A, B, C, D T4 | | |

| Power supply and signal circuit with "intrinsic safety" type of protection, with the following maximum values | | |
|---|---------------|-------------|
| | Vmax = 30 V | Ui = 30 V |
| | Imax = 100 mA | Ii = 100 mA |
| | Pmax = 1 W | Pi = 1 W |
| Effective internal capacitance | Ci = 3.7 nF | Ci = 3.7 nF |
| Effective internal inductance | Li = 0 μH | Li = 0 μH |

Notes

ABB Ltd.**Measurement & Analytics**

Howard Road, St. Neots
Cambridgeshire, PE19 8EU
UK

Tel: +44 (0)870 600 6122

Fax: +44 (0)1480 213 339

Email: enquiries.mp.uk@gb.abb.com

ABB S.p.A.**Measurement & Analytics**

Via Luigi Vaccani 4
22016 Tremezzina (CO)

Italy

Tel: +39 0344 58111

ABB Inc.**Measurement & Analytics**

125 E. County Line Road
Warminster, PA 18974
USA

Tel: +1 215 674 6000

Fax: +1 215 674 7183

abb.com/measurement

We reserve the right to make technical changes or modify the contents of this document without prior notice. With regard to purchase orders, the agreed particulars shall prevail. ABB does not accept any responsibility whatsoever for potential errors or possible lack of information in this document.

We reserve all rights in this document and in the subject matter and illustrations contained therein. Any reproduction, disclosure to third parties or utilization of its contents – in whole or in parts – is forbidden without prior written consent of ABB.