

BA304E & BA324E
intrinsically safe
loop-powered
field mounting indicators
Issue 4

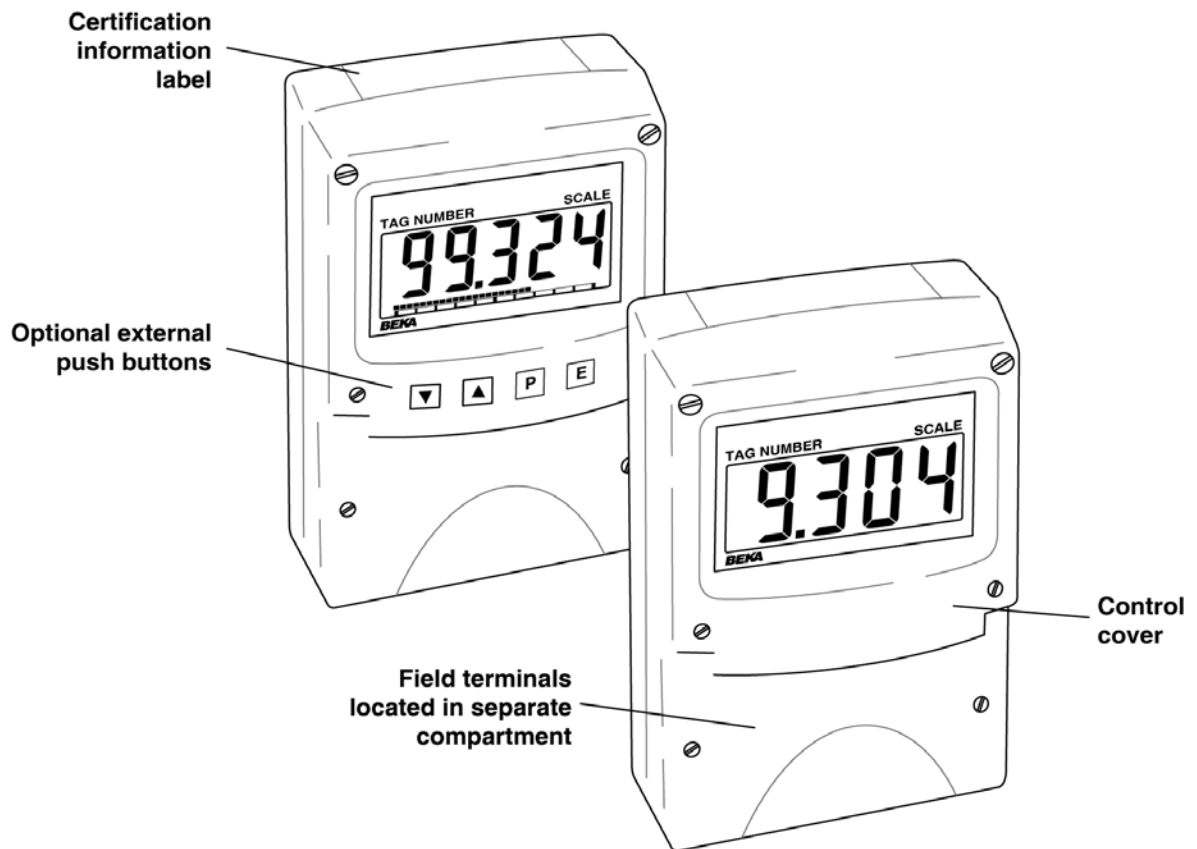

CONTENTS

- 1. Description**
- 2. Operation**
 - 2.1 Controls
- 3. Intrinsic safety certification**
 - 3.1 ATEX gas certificate
 - 3.2 Zones, gas groups & T rating
 - 3.3 4/20mA input
 - 3.4 Certification label information
- 4. System Design for Gas Hazardous Areas**
 - 4.1 Transmitter loops
 - 4.2 Remote indication
- 5. Installation**
 - 5.1 Location
 - 5.2 Installation procedure
 - 5.3 EMC
- 6. Configuration and Calibration**
 - 6.1 Summary of configuration functions.
 - 6.2 Indicator function
 - 6.3 Resolution
 - 6.4 Position of decimal point
 - 6.5 Calibration using an external current source.
 - 6.6 Calibration using internal reference.
 - 6.7 Bargraph format and calibration
 - 6.8 Function of the *P* push-button
 - 6.9 Tare function
 - 6.10 Security code
 - 6.11 Under and over-range
- 7. Lineariser**
 - 7.1 Lineariser calibration using an external current source.
 - 7.2 Lineariser calibration using internal reference.
 - 7.3 Lineariser error message
 - 7.4 Lineariser default configuration
- 8. Maintenance**
 - 8.1 Fault finding during commissioning
 - 8.2 Fault finding after commissioning
 - 8.3 Servicing
 - 8.4 Routine maintenance
 - 8.5 Guarantee
 - 8.6 Customer comments
- 9. Accessories**
 - 9.1 External keypad
 - 9.2 Units of measurement and instrument identification.
 - 9.3 Alarms
 - 9.3.1 Solid state output
 - 9.3.2 Intrinsic safety
 - 9.3.3 Configuration and adjustment.
 - 9.3.4 Alarm enable
 - 9.3.5 Setpoint adjustment
 - 9.3.6 Alarm function
 - 9.3.7 Alarm output status
 - 9.3.8 Hysteresis
 - 9.3.9 Alarm delay
 - 9.3.10 Alarm silence time
 - 9.3.11 Flash display when alarm occurs.
 - 9.3.12 Access setpoint in display mode.
 - 9.3.13 Adjusting alarm setpoint from the display mode.
 - 9.3.14 Displaying setpoints on BA324E bargraph.
 - 9.4 Display backlight
 - 9.4.1 Loop powering the backlight
 - 9.4.2 Separately powering the backlight.
 - 9.5 Pipe mounting kits
- Appendix 1** ATEX dust certification
- Appendix 2** IECEx gas and dust certification
- Appendix 3** FM and cFM certification

The BA304E & BA324E are CE marked to show compliance with the European Explosive Atmospheres Directive 94/9/EC and the European EMC Directive 2004/108/EC

1. DESCRIPTION

These field mounting, intrinsically safe digital indicators display the current flowing in a 4/20mA loop in engineering units. They are loop powered but only introduce a 1.2V drop, which allows them to be installed into almost any 4/20mA current loop. No additional power supply or battery is required.

The two models are electrically similar, but have different size displays.

Model	Display
BA304E	4 digits 34mm high
BA324E	5 digits 29mm high and 31 segment Bargraph.

This instruction manual supplements the instruction sheet supplied with each instrument.

The main application of both models is to display a measured variable or control signal in a hazardous process area. The zero and span of the display are independently adjustable so that the indicator can be calibrated to display any variable represented by the 4/20mA current, e.g. temperature, flow, pressure or level.

Both models have been certified intrinsically safe for use in gas and dust hazardous areas by Notified Body Intertek Testing and Certification Ltd and comply with the European ATEX Directive 94/9/EC. Dust certification is an option described in Appendix 1 which must be request when the instrument is ordered. The EC-Type Examination certificate specifies that under fault conditions the output voltage, current and power at the 4/20mA input terminals will not exceed those specified for *simple apparatus* in Clause 5.7 of EN 60079-11, which simplifies installation and documentation.

For international applications both models have IECEx certification which is described in Appendix 2.

For installations in the USA and Canada both models have FM and cFM certification which is described in Appendix 3. FM and cFM certification is an option which must be request when the instrument is ordered.

2. OPERATION

Fig 1 shows a simplified block diagram of both models. The 4/20mA input current flows through resistor R1 and forward biased diode D1. The voltage developed across D1, which is relatively constant, is multiplied by a switch mode power supply and used to power the instrument. The voltage developed across R1, which is proportional to the 4/20mA input current, provides the input signal for the analogue to digital converter.

Each time a 4/20mA current is applied to the instrument, initialisation is performed during which all segments of the display are activated, after five seconds the instrument displays the input current using the calibration information stored in the instrument memory. If the loop current is too low to power the instrument the indicator will display the error message 'LPLo'.

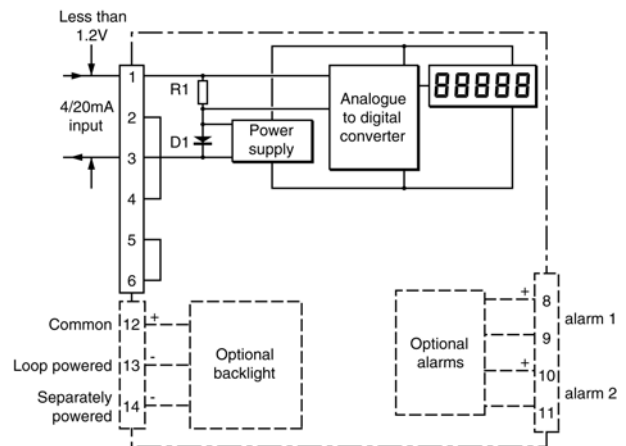

Fig 1 Indicator block diagram

2.1 Controls

The indicators are controlled and calibrated via four push-button switches located behind the instrument control cover, or as an option on the control cover. In the display mode i.e. when the indicator is displaying a process variable, these push-buttons have the following functions:

- P** While this button is pushed the indicator will display the input current in mA, or as a percentage of the instrument span depending upon how the indicator has been conditioned. When the button is released the normal display in engineering units will return. The function of this push-button is modified when optional alarms are fitted to the indicator.
- ▼** While this button is pushed the indicator will display the numerical value and analogue bargraph* the indicator has been calibrated to display with a 4mA^Φ input. When released the normal display in engineering units will return.
- ▲** While this button is pushed the indicator will display the numerical value and analogue bargraph* the indicator has been calibrated to display with a 20mA^Φ input. When released the normal display in engineering units will return.
- E** No function in the display mode unless the tare function is being used.
- P + ▼** Indicator displays firmware number followed by version.
- P + ▲** Provides direct access to the alarm setpoints when optional alarms are fitted to the indicator and the 'ACSP' access setpoints in display mode function has been enabled.
- P + E** Provides access to the configuration menu via optional security code.

Note: * BA324E only
 Φ If the indicator has been calibrated using the CAL function, calibration points may not be 4 and 20mA.

3. INTRINSIC SAFETY CERTIFICATION

Both models have ATEX and IECEx gas and dust certification. This section of the instruction manual describes ATEX gas certification. ATEX dust and IECEx approvals are described in Appendixes 1 and 2.

3.1 ATEX gas certification

Notified Body Intertek Testing and Certification Ltd have issued both models with a common EC-Type Examination Certificate number ITS11ATEX27253. This confirms compliance with harmonised European standards and it has been used to confirm compliance with the European ATEX Directive for Group II, Category 1G equipment, Ex ia IIC T5 Ga Ta = -40 to +70°C. The indicators bear the community mark and subject to local codes of practice may be installed in any of the European Economic Area (EEA) member countries. ATEX certificates are also acceptable for installations in Switzerland.

This section of the instruction manual describes ATEX installations in explosive gas atmospheres conforming with EN60079-14 Electrical Installations in Hazardous Areas. When designing systems for installation outside the UK the local Code of Practice should be consulted.

3.2 Zones, gas groups and T rating

Both indicators have been certified Ex ia IIC T5. When connected to a suitable system they may be installed in:

- Zone 0 explosive gas air mixture continuously present.
- Zone 1 explosive gas air mixture likely to occur in normal operation.
- Zone 2 explosive gas air mixture not likely to occur, and if it does will only exist for a short time.

Be used with gases in groups:

- Group A propane
- Group B ethylene
- Group C hydrogen

Having a temperature classification of:

- T1 450°C
- T2 300°C
- T3 200°C
- T4 135°C
- T5 100°C

At ambient temperatures between -40 and +70°C.

This allows the indicators to be installed in all gas Zones and to be used with most common industrial gases.

3.3 4/20mA input

The input safety parameters for the 4/20mA input, terminals 1 and 3 are:

$$\begin{aligned} U_i &= 30\text{V dc} \\ I_i &= 200\text{mA} \\ P_i &= 0.84\text{W} \end{aligned}$$

The maximum equivalent capacitance and inductance between the two 4/20mA input terminals 1 and 3 is:

$$\begin{aligned} C_i &= 13\text{nF} \\ L_i &= 16\mu\text{H} \end{aligned}$$

The maximum permitted loop cable parameters can be calculated by adding these figures to C_i and L_i of other instruments in the loop and subtracting the totals from the maximum cable capacitance C_o and cable inductance L_o permitted for the Zener barrier or galvanic isolator powering the loop.

Although the indicators do not themselves comply with the requirements for *simple apparatus*, the EC-Type Examination Certificate states that for intrinsic safety considerations, under fault conditions the output voltage, current and power at terminals 1 & 3 will not exceed those specified by clause 5.7 of EN 60079-11 for *simple apparatus*. This simplifies the application and intrinsic safety documentation for a loop into which an indicator is connected. Apart from C_i , the effect of the indicator may be ignored when assessing loop safety.

3.4 Certification label information

The certification label is fitted in a recess on the top outer surface of the instrument enclosure. It shows the ATEX certification information and BEKA associates' name and location. Non European certification information may also be shown. The instrument serial number and date of manufacturer are recorded on a separate label inside the terminal compartment.

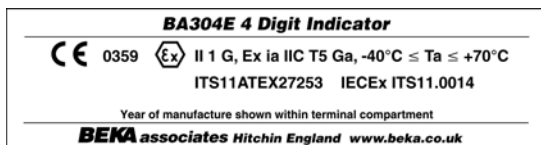

BA304E certification label

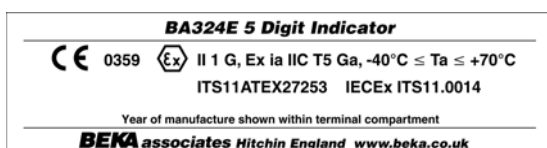

BA324E certification label

4. SYSTEM DESIGN FOR GAS HAZARDOUS AREAS

4.1 Transmitter loops

Both models may be connected in series with almost any intrinsically safe 4/20mA current loop and calibrated to display the measured variable or control signal in engineering units. There are three basic design requirements:

1. The intrinsic safety output parameters of the 4/20mA loop, which are defined by the Zener barrier or galvanic isolator powering the loop, must be equal to or less than:

$$\begin{aligned} U_o &= 30\text{V dc} \\ I_o &= 200\text{mA} \\ P_o &= 0.84\text{W} \end{aligned}$$

2. The maximum permitted cable capacitance of the loop must be reduced by 13nF. The maximum permitted cable inductance is not reduced by the inclusion of the indicator.
3. The loop must be able to tolerate the additional 1.2V required to operate the indicator. When fitted with an optional backlight this increases to 5.0V if the backlight is loop powered. See 9.4.1

Figs 2a and 2b illustrate typical applications in which an indicator is connected in series with a 2-wire transmitter powered by a Zener barrier and alternatively by a galvanic isolator.

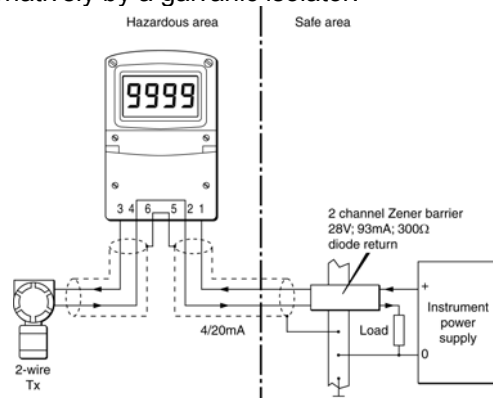

Fig 2a Loop powered by a Zener barrier

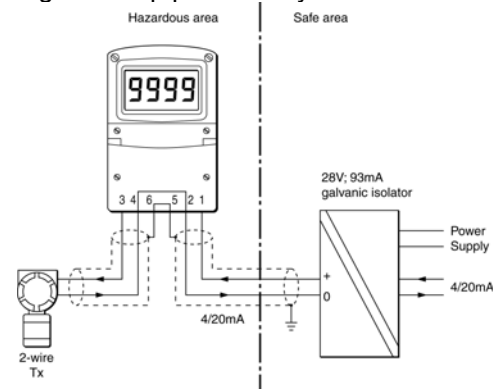

Fig 2b Loop powered by a galvanic isolator

4.2 Remote indication

The indicators may be driven via an intrinsically safe interface from a 4/20mA safe area signal to provide a remote display within a hazardous area. The type of intrinsically safe interface is not critical, either a Zener barrier or a galvanic isolator may be used, providing that U_i , I_i and P_i of the indicator are not exceeded and the voltage capability of the 4/20mA signal is sufficient to drive the indicator plus the interface.

When a high integrity earth connection is already available, a Zener barrier is usually the least expensive option. If an earth connection is not available or isolation is required, a galvanic isolator is the correct choice.

If one side of the 4/20mA current loop may be earthed, a single channel Zener barrier provides the lowest cost protection. If the 4/20mA signal is not isolated, then two Zener barriers, a two channel Zener barrier or a galvanic isolator must be used.

Fig 3 shows the alternative circuits which may be used.

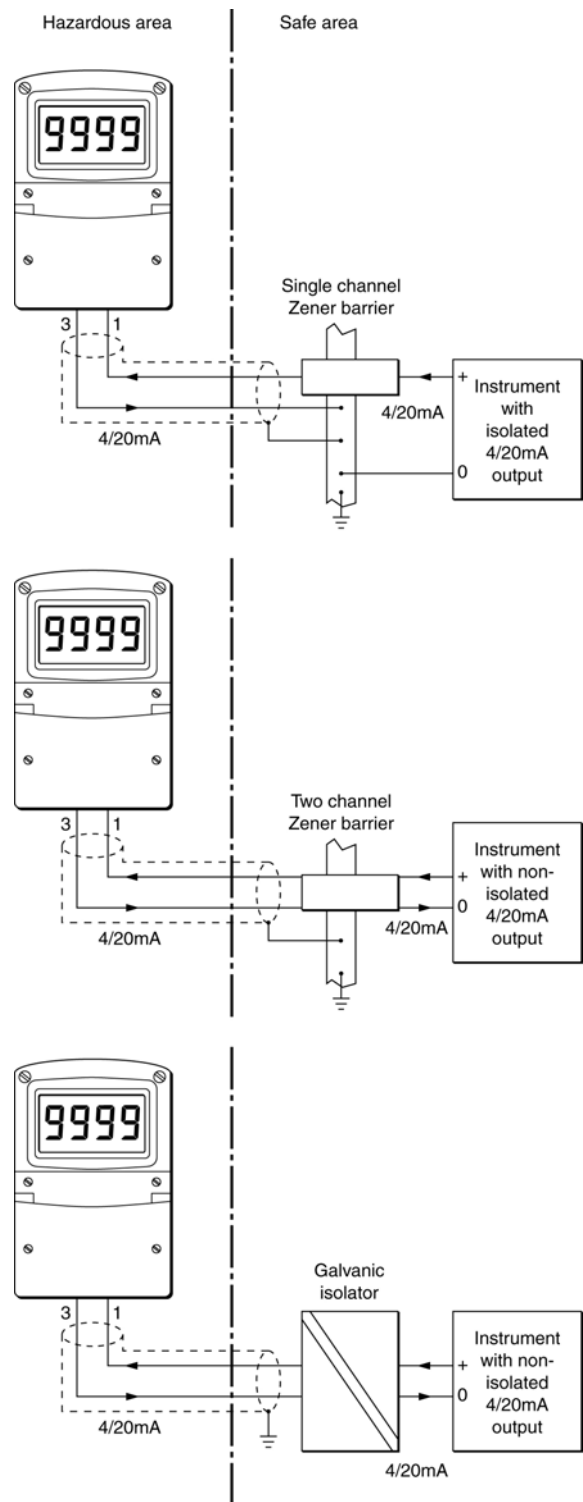

Fig 3 Alternative circuits for remote indication in a hazardous area

5. INSTALLATION

5.1 Location

The BA304E and BA324E indicators are housed in robust IP66 glass reinforced polyester (GRP) enclosures incorporating an armoured glass window and stainless steel fittings making them suitable for exterior mounting in most industrial installations, including off-shore and waste water treatment. The indicators should be positioned where the display is not in continuous direct sunlight.

Both indicators are surface mounting, but may be pipe mounted using one of the accessory kits described in section 9.5 of this manual. The field terminals and the two mounting holes are located in a separate compartment with a sealed cover allowing the instrument to be installed without exposing the display assembly.

Terminals 2 and 4 are internally joined and may be used for linking the return 4/20mA wire - see Fig 2. Similarly terminals 5 and 6 are internally joined and may be used for linking cable screens. The indicator's earth terminal is connected to the carbon loaded GRP enclosure. If this enclosure is not bolted to an earthed post or structure, the earth terminal should be connected to the plant potential equalising conductor.

The enclosures are fitted with a bonding plate to ensure electrical continuity between the three conduit / cable entries.

5.2 Installation Procedure

Fig 4 illustrates the instrument installation procedure.

- Remove the instrument terminal cover by unscrewing the two captive 'A' screws.
- Mount the instrument on a flat surface and secure with screws or bolts through the two 'B' holes. Alternatively use one of the pipe or stem mounting kits described in section 9.5.
- Remove the temporary dust seals from the three cable entries and install the required glands, conduit fittings or blanking plugs. Note: the temporary dust seals do not provide IP66 protection.
- Connect the field wiring to the terminals as shown in Fig 5.
- Replace the instrument terminal cover and evenly tighten the two 'A' screws.

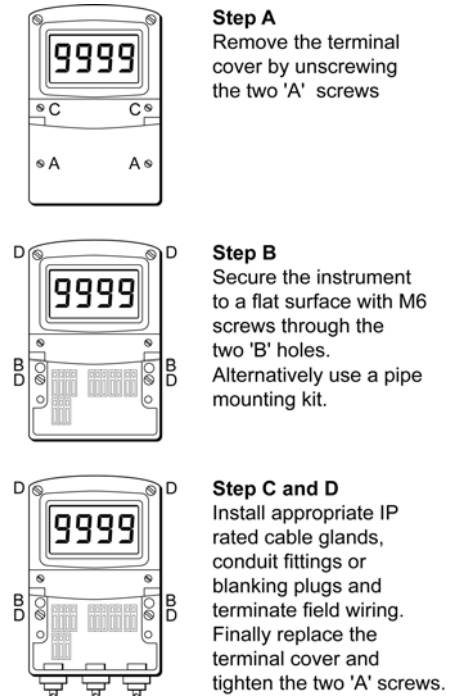

Fig 4 BA304E & BA324E installation procedure

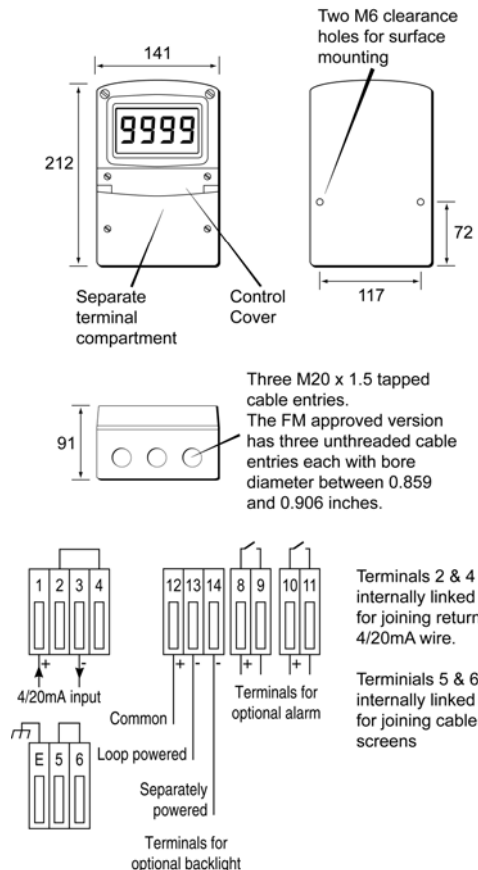

Fig 5 Dimensions and terminal connections

5.3 EMC

Both instruments comply with the requirements of the European EMC Directive 2004/108/EC. For specified immunity all wiring should be in screened twisted pairs, with the screens earthed in the safe area.

6. CONFIGURATION AND CALIBRATION

Both indicators are configured and calibrated via the four push buttons which are located behind the control cover. All the configuration functions are contained in an easy to use intuitive menu that is shown diagrammatically in Fig 6.

Each menu function is summarised in section 6.1 and includes a reference to more detailed information. When the indicator is fitted with alarms additional functions are added to the menu which are described in section 9.3

Throughout this manual push-buttons are shown as **P**, **E**, **▼** or **▲**, and legends displayed by the indicator are shown within inverted commas e.g. 'CAL' and 'ALr2'.

Access to the configuration menu is obtained by operating the **P** and **E** push buttons simultaneously. If the indicator security code is set to the default 0000 the first parameter 'FunC' will be displayed. If a security code other than the default code 0000 has already been entered, the indicator will display 'CodE'. Pressing the **P** button will clear this prompt allowing each digit of the code to be entered using the **▲** and **▼** push buttons and the **P** button to move control to the next digit. When the correct four digit code has been entered pressing **E** will cause the first parameter 'FunC' to be displayed. If the code is incorrect, or a button is not pressed within twenty seconds, the indicator will automatically return to the display mode.

Once within the configuration menu the required parameter can be reached by scrolling through the menu using the **▲** and **▼** push buttons as shown in Fig 6. When returning to the display mode following recalibration or a change to any function, the indicator will display 'dAtA' followed by 'SAVE' while the new information is stored in non-volatile memory.

All new indicators are supplied calibrated as requested at the time of ordering. If calibration is not requested, indicators will be supplied with the following default configuration:

Default Configuration

	BA304E	BA324E
Access code 'CodE'	0000	0000
Function 'FunC'	Linear	Linear
Display at 4mA 'Zero'	0.0	0.00
Display at 20mA 'SPAn'	100.0	100.00
Resolution 'rESn'	1 digit	1 digit
Bargraph start 'BarLo'	----	0.00
Bargraph finish 'BarHi'	----	100.00
P button in display mode 'C—P'	%	%
Tare 'tArE'	Off	Off

6.1 Summary of configuration functions

This section summarises each of the main configuration functions and includes a cross reference to a more detailed description. Fig 6 illustrates the location of each function within the configuration menu. The lineariser and the optional factory fitted alarms are described separately in sections 7 and 9.3 of this manual.

Display	Summary of function
'FunC'	Indicator function Defines the relationship between the 4/20mA input current and the indicator display. May be set to: 'Std' Standard linear relationship 'root' Square root extraction 'Lin' 16 segment adjustable lineariser – see section 7. See section 6.2
'rESn'	Display resolution Defines the resolution of the least significant display digit. May be set to '1', '2', '5' or '10' digits. See section 6.3
'dP'	Decimal point Positions a dummy decimal point between any of the digits or turns it off. See section 6.4
'CAL'	Calibration of the digital display using an external current source. Enables the zero and span of the indicator to be adjusted using an external current source such as a calibrator. When used with an accurate traceable current source this is the preferred method of calibration. See section 6.5
'SEt'	Calibration of display using internal references. Enables the zero and span of the indicator to be adjusted without the need for an accurate input current or disconnection from the 4/20mA loop. See section 6.6
'bAr'	Bargraph format and calibration <i>Only the BA324E has a bargraph</i> The bargraph may be conditioned to start from left, right or centre of the display, or it may be disabled. When optional alarms are fitted it can also display both alarm setpoints and the measured value. The bargraph may be calibrated to start and finish at any value within the indicator's calibrated digital display. See section 6.7

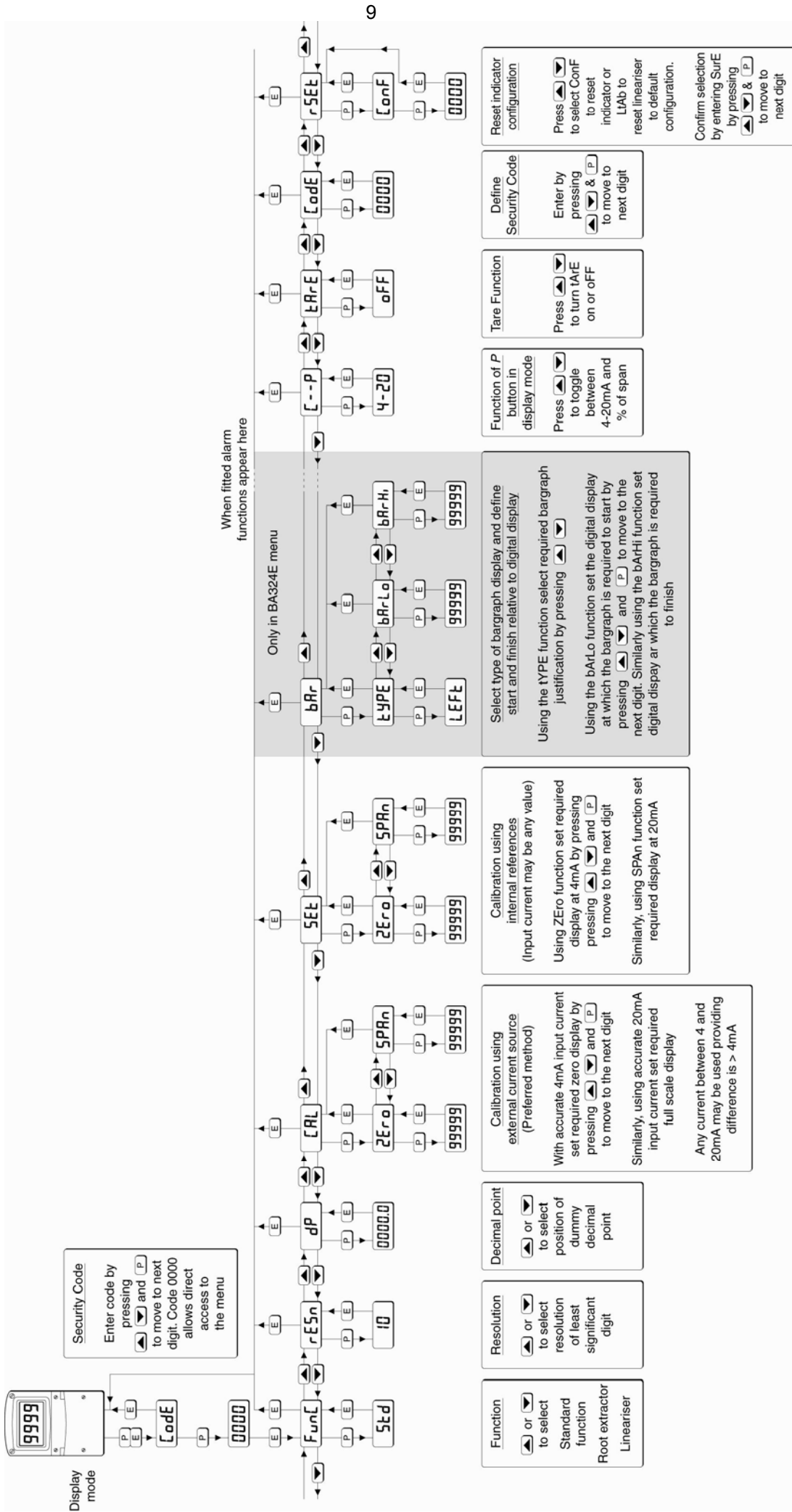

Fig 6 Configuration menu

Display Summary of function

- 'C - - P' Function of P push-button**
The indicator may be configured to display the input current in milliamps, or the input current as a percentage of the 4/20mA input when the **P** push button is operated in the display mode.
See section 6.8
- 'tArE' Tare function**
When enabled the tare function sets the indicator display to zero when the **E** push button is operated in the display mode.
See section 6.9
- 'CodE' Security code**
Defines a four digit numeric code that must be entered to gain access to the configuration menu. Default code 0000 disables this security function and allows unrestricted access to all conditioning functions.
See section 6.10
- 'rSEt' Reset**
Contains two sub-functions, 'ConF' which returns the indicator to the default conditions shown in section 6.0 and 'LtAb' which returns the lineariser to the default conditions shown in section 7.3. To prevent accidental use both resets must be confirmed by entering '5urE' before they will be executed.
See section 6.11

6.2 Indicator function: 'FunC'

This configuration function defines the relationship between the indicator's 4/20mA input current and the indicator's display. Three alternatives are available:

'Std'	Standard linear relationship
'root'	Square root extraction
'Lin'	16 segment adjustable lineariser

To reveal the existing indicator function select 'FunC' from the configuration menu and press **P**. If the function is set as required, press **E** to return to the menu, or press the **▲** or **▼** button to change the setting, followed by the **E** button to return to the configuration menu.

'Std' Linear

Provides a linear relationship between the 4/20mA indicator input current and the indicator display.

'root' Square root extraction

Primarily intended to linearise the square law 4/20mA output from differential flowmeters.

For reference, the following table shows the output current from a non-linearised differential flowmeter.

% of full flow	Current output mA
2.5	4.01
10.0	4.16
25.0	5.00
50.0	8.00
75.0	13.00
100.0	20.00

When the root function is selected the indicator will display flow in linear units.

'Lin' 16 segment adjustable lineariser

Enables non-linear variables to be displayed by the indicator in linear engineering units. Use of the lineariser is described in section 7 of this instruction manual.

6.3 Resolution: rESn

This function defines the resolution of the least significant display digit. Decreasing the display resolution can improve the readability of a noisy signal. Select 'rESn' from the menu and press **P** which will reveal the current display resolution. To change the resolution press the **▲** or **▼** button to select 1, 2, 5 or 10 digits, followed by the **E** button to enter the selection and return to the configuration menu.

6.4 Position of the decimal point: 'dP'

A dummy decimal point can be positioned between any of the digits or it may be absent. To position the decimal point select 'dP' from the menu and press **P**. The decimal point can be moved by pressing the **▲** or **▼** push-button. If a decimal point is not required it should be positioned beyond the most or least significant digit. When positioned as required press the **E** button to enter the selection and return to the configuration menu.

6.5 Calibration using an external current source: 'CAL'

This function enables the zero and span of the indicator to be adjusted using an external calibrated current source. When used with an accurate traceable current source this is the preferred method of calibration.

Zero is the indicator display with 4mA input
Span is the indicator display with 20mA input

To calibrate the indicator select 'CAL' from the configuration menu and press **P**. The indicator will display 'ZEro' which is a request for a 4mA input current. Adjust the external current calibrator to 4.000mA and again press **P** which will reveal the current zero display. The flashing digit of the indicator display can be changed by pressing the **▲** or **▼** buttons, when set as required pressing **P** will transfer control to the next digit. When all the digits have been adjusted, press **E** to enter the new zero and return to the 'ZEro' prompt.

Pressing the **▲** button will cause the indicator to display 'SPAn' which is a request for a 20mA input current. Adjust the external current calibrator to 20.000mA and again press **P** which will reveal the existing span display. The flashing digit of the indicator display can be changed by pressing the **▲** or **▼** buttons, when set as required pressing **P** will transfer control to the next digit. When all the digits have been adjusted press **E** to enter the new span and return to the 'SPAn' prompt. Finally press **E** again to return to the configuration menu.

Notes:

- The indicator input current must be adjusted to the required value before the zero and span functions are entered by pressing the **P** button.
- Indicators may be calibrated at currents other than 4 and 20mA, within the range 3.8 to 21.0mA providing the difference between the two currents is greater than 4mA. If these conditions are not complied with, the indicator displays 'Fail' and aborts the calibration.
- If the zero current is greater than the span current the instrument will be reverse acting i.e. an increasing input current will cause the display to decrease.

6.6 Calibration using internal reference: 'SEt'

Using the 'SEt' function the indicator can be calibrated without the need to know the value of the 4/20mA input current, or to disconnect the indicator from the 4/20mA loop.

When using the 'Set' function the indicator's internal reference is used to simulate a 4mA and 20mA input current.

Zero is the display with a simulated 4mA input
Span is the display with a simulated 20mA input

To calibrate the indicator display select 'SEt' from the configuration menu and press **P**. The indicator will display 'ZEro', pressing **P** again will reveal the current display at 4mA. The flashing digit can be adjusted by pressing the **▲** or **▼** buttons, when the flashing digit is correct pressing **P** will transfer control to the next digit. When all the digits have been adjusted, press **E** to return to the 'ZEro' prompt.

To adjust the display at 20mA, press the **▲** button which will cause the indicator to display 'SPAn', pressing **P** will then reveal the indicator's existing display at 20mA. The flashing digit can be adjusted by pressing the **▲** or **▼** buttons, when the flashing digit is correct pressing **P** will transfer control to the next digit. When all the digits have been adjusted press **E** to return to the 'SPAn' prompt followed by **E** to return to the 'SEt' prompt in the configuration menu.

6.7 Bargraph format and calibration: 'bAr'

Only the BA324E has a bargraph

In addition to a five digit numerical display the BA324E has a 31 segment analogue bargraph which may be configured to start and finish anywhere within the indicator's numerical display range.

To configure the bargraph select 'bAr' from the configuration menu and press **P**. The indicator will display 'tYPE', pressing **P** again will reveal the existing bargraph justification which can be changed to one of the following four or five options using the **▲** or **▼** button:

	Bargraph justification starts from
'LEfT'	Left end of display
'CEntr'	Centre of display
'riGHt'	Right end of display
'AlrSP'	Only with alarms – see section 9.3
'oFF'	Bargraph disabled

When set as required press **E** to return to the 'tYPE' sub-function prompt.

The indicator's digital display at which the bargraph starts is defined by the 'bArLo' sub-function which is selected by pressing the ▲ button followed by the **P** button which will reveal the current indicator display at which the bargraph starts. The flashing digit can be adjusted by pressing the ▲ or ▼ buttons, when set as required pressing **P** will transfer control to the next digit. When all the digits have been adjusted, press **E** to return to the 'bArLo' prompt from which 'bArHi' which defines the finishing point of the bargraph can be selected by pressing the ▲ button. 'bArHi' is adjusted in the same way as 'bArLo'. When set as required, pressing **E** twice will return the display to the 'bAr' prompt in the configuration menu.

Note: 'bArLo' must be set lower than 'bArHi', incorrect setting is indicated by the bargraph scale flashing with a single bargraph segment activated.

6.8 Function of the **P** push-button: 'C - - P'

When the indicator is in the display mode, operating the **P** push-button will display the input current in milliamps, or the displayed value as a percentage of the difference between the displayed values at 4mA and 20mA inputs.

To check or change the function of the **P** push-button select 'C - -P' from the configuration menu and press **P** to reveal the current setting. Pressing the ▲ or ▼ button will toggle the setting between '4-20' the current display in milliamps and 'PC' the percentage display. When set as required press **E** to return to the 'C - - P' prompt in the configuration menu.

6.9 Tare function: 'tArE'

The tare function is primarily intended for use with weighing system. When the indicator is in the display mode and the tare function is activated, pressing the **E** button for more than three seconds will zero the indicator's digital display and activate the tare annunciator. On the BA324E the bargraph remains linked to the digital display when the tare function is activated. Subsequent operation of the **E** push-button for less than 3 seconds will return the indicator to the gross display and deactivate the tare annunciator.

To check or change the tare function select 'tARE' from the configuration menu and press **P** to reveal the current setting. Pressing the ▲ or ▼ button will toggle the setting between 'on' and 'off'. When set as required press **E** to return to the 'tARE' prompt in the configuration menu.

6.10 Security code: 'CodE'

Access to the instrument configuration menu may be protected by a four digit security code which

must be entered to gain access. New instruments are configured with the default security code 0000 which allows unrestricted access to all configuration functions.

To enter a new security code select 'CodE' from the configuration menu and press **P** which will cause the indicator to display the existing security code with one digit flashing. The flashing digit can be adjusted using the ▲ and ▼ push-buttons, when set as required operating the **P** button will transfer control to the next digit. When all the digits have been adjusted press **E** to return to the 'CodE' prompt in the configuration menu. The revised security code will be activated when the indicator is returned to the display mode. Please contact BEKA associates sales department if the security code is lost.

6.11 Reset to factory defaults: 'rSET'

This function enables the indicator and the lineariser to be quickly returned to the factory default configurations shown in sections 6.0 and 7.3

To reset the indicator or lineariser select 'rSET' from the configuration menu and press **P**, the indicator will display one of the reset options 'ConF' or 'LtAb'.

'ConF' Resets the indicator to defaults
'LtAb' Resets the lineariser to defaults

Using the ▲ or ▼ push-button select the required sub-function and press **P**. To prevent accidental resetting the request must be confirmed by entering '5urE'. Using the ▲ button set the first flashing digit to '5' and press **P** to transfer control to the second digit which should be set to 'u'. When '5urE' has been entered pressing the **E** button will reset the selected configuration menus and return the display to the 'rSET' function in the configuration menu.

6.12 Under and over-range

If the numerical display range of the indicator is exceeded, all the decimal points will flash as shown below:

	BA304E	BA324E
Underrange	-9.9.9.9	-9.9.9.9.9
Overrange	9.9.9.9	9.9.9.9.9

Although not guaranteed, most indicators will continue to function normally with an input current between 1.8mA and 4mA, at lower currents the instrument will display 'LPLo' before it stops functioning.

Under or overrange of the BA324E bargraph is indicated by an activated arrow at the appropriate end of the bargraph and a flashing bargraph scale.

7. LINEARISER

A sixteen segment, seventeen breakpoint lineariser may be selected in the 'FunC' section of the configuration menu. The starting point and slope of each straight line segment are fully adjustable allowing the indicator to display most non-linear process variables in linear engineering units. Each break-points must occur at a current greater than the preceeding break-point and less than the following break-point, in the range 3.8 to 21.0mA Fig 8 shows a typical linearised indicator characteristic. Fig 7 shows a typical linearised indicator characteristic.

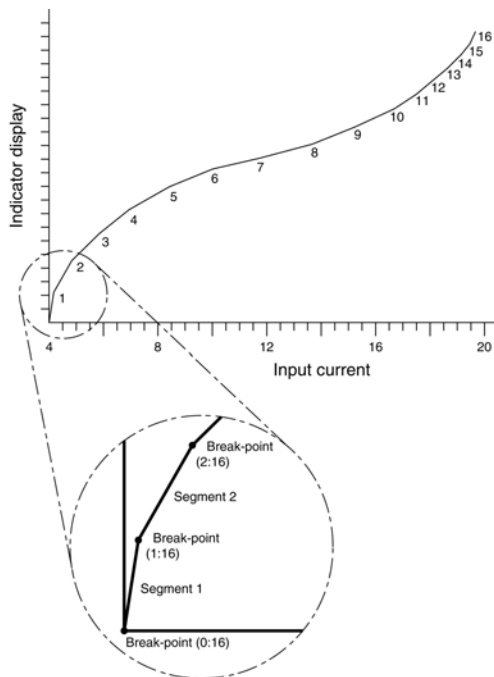

Fig 7 shows a typical linearising characteristic

Selecting 'Lin' in the 'FunC' section of the configuration menu activates the lineariser, this does not change the configuration menu shown in Fig 6, but the 'CAL' and 'SET' functions are extended as shown in Fig 8. As with a linear indicator, calibration may be performed with an external current source using the 'CAL' function, or with the internal reference using the 'SET' function.

The lineariser configuration is retained irrespective of how the the indicator function 'FunC' is subsequently changed. It is therefore possible to select and deselect the lineariser without having to reconfigure it each time.

7.1 Lineariser calibration using an external current source.

This method allows direct calibration of the lineariser with an external current source and is the preferred method when traceability is required. If the exact system non-linearity is unknown, this method also allows direct calibration from the

variable to be displayed. e.g. the output from a level sensor in an irregular tank may be displayed in linear volumetric units by filling the tank with known incremental volumes and calibrating the indicator to display the sum of the increments at each break-point.

The number of break-point required should first be entered using the 'Add' and 'dEL' functions. In both these sub-functions the indicator initially displays the current break-point and the total number of break-points being used as shown below.

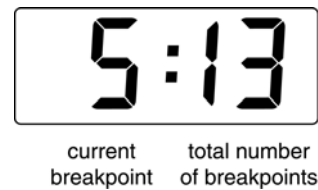

Display	Description of function
'Add'	Add a break-point Adds a new break-point before the displayed break-point. The calibration of existing break-points is not changed, but the identification number of all subsequent break-points is increased by one.
'dEL'	Remove a break-point Removes the displayed break-point and joins the preceding break-point to the following break-point with a straight line. The identification number of all subsequent break-points is decreased by one.

To add a break-point use the ▲ or ▼ button to select 'CAL' from the configuration menu and press **P** which will result in the 'Add' sub-function prompt being displayed. To enter the sub-function press **P** which will reveal the current break-point and the total number of break-points which have already been entered. Each subsequent operation of the **P** push-button will introduce an additional break-point up to the maximum of 17. When adding a break-point to a calibrated indicator, the insertion position for the new segment can be selected using the ▲ and ▼ push-buttons.

The delete break-point sub-function 'dEL' operates in exactly the same way as the 'Add' sub-function described above. Once within the 'dEL' sub-function each time the **P** button is pressed a break-point is removed. When deleting a break-point from a calibrated indicator, the break-point to be deleted can be selected using the ▲ and ▼ push-buttons. The minimum number of break-point is 2, break points 0 and 1.

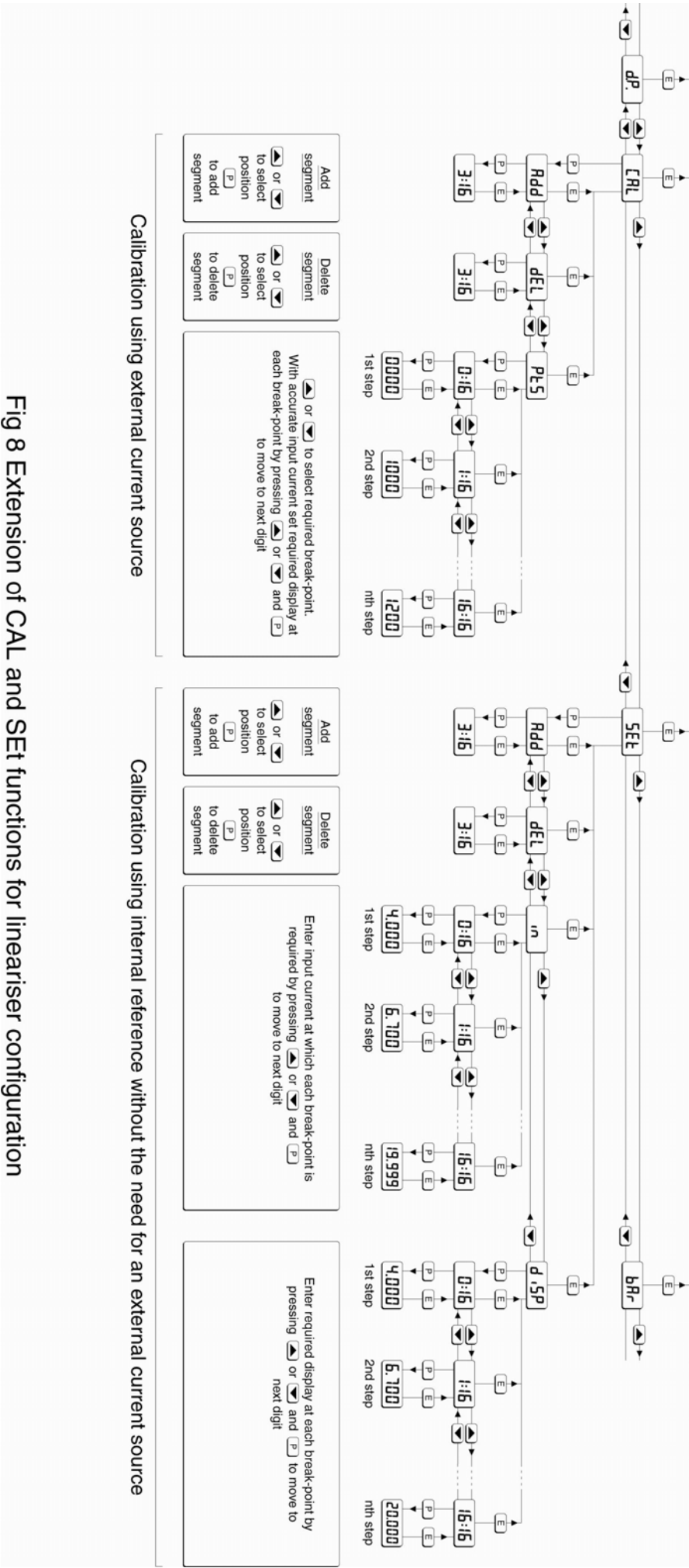

Fig 8 Extension of CAL and SET functions for lineariser configuration

When the required number of linearising break-points have been entered, return to the linearisation sub-menu by pressing **E**. The indicator will display the 'Add' or 'dEL' prompt depending upon the last function used.

Now that the the number of break-points has been entered, the input current at which each occurs and the corresponding indicator display can be defined by th 'Pts' sub-function.

Using the ▲ or ▼ button select 'PtS' from the sub-menu and press **P** which will select the starting point for the first segment '0 : n', where n is the total number of linearising break-points entered. The selected linearising break-point can be changed using the ▲ and ▼ buttons. When the required linearising break-point has been selected set the indicator input current to the exact value at which the break-point is required and press **P**. Using the ▲ and ▼ buttons and the **P** button to move between digits, enter the required indicator display at this break-point.

When set as required, press the **E** push-button to enter the required indicator display and return to the sub-menu from which the next beak-point can be selected.

When all the break-points have been calibrated pressing **E** twice will return the indicator to the 'CAL' function in the configuration menu.

Note: The indicator input current must be adjusted to the required value before the **P** button is operated to enter the required indicator display.

7.2 Lineariser calibration using the internal reference.

The 'SEt' function enables the lineariser to be calibrated without the need for an accurate external current source. Throughout the calibration the indicator input current may be any value between 4 and 20mA.

The 'SEt' functions contains four sub-functions.

Display Description of function

'Add' **Add a break-point**
Adds a new break-point before the displayed break-point. The calibration of existing break-points is not changed, but the identification number of all subsequent break-point is increased by one.

'dEL' **Remove a break-point**
Removes the displayed break-point and joins the preceding segment to the following segment with a straight line. The identification number of all subsequent break-points is decreased by one.

'in' **Defines the current at which break-point occurs.**
Enables the required current at each break-point to be defined without having to input an accurate input current to the indicator.

'diSP' **Defines indicator display at break-point.**
Enables the indicator display at each break-point to be defined.

The number of break-point required should first be entered using the 'Add' and 'dEL' sub-functions. In both these sub-functions the indicator initially displays the current break-point and the total number of break-point being used as shown below.

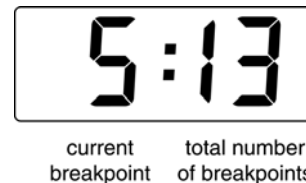

To add a break-point using the ▲ or ▼ button select 'SEt' from the configuration menu and press **P** which will result in the 'Add' sub-function prompt being displayed. To enter the sub-function press **P** which will reveal the current break-point and the total number of break-point which have already been entered. Each subsequent operation of the **P** push-button will introduce an additional break-point up to the maximum of 17. When adding a break-point to a calibrated indicator, the insertion position for the new segment can be selected using the ▲ and ▼ push-buttons.

The delete break-point, sub-function 'dEL' operates in exactly the same way as the 'Add' sub-function described above. Once within the 'dEL' function each time the **P** button is pressed a break-point is removed. When deleting a break-point from a calibrated indicator, the break-point to be deleted can be selected using the ▲ and ▼ push-buttons. The minimum number of break-point is 2, break-points 0 and 1.

When the required number of linearising break-point has been entered, return to the linearisation sub-menu by pressing **E**. The indicator will display the 'Add' or 'dEL' prompt depending upon the last sub-function used. The indicator input current and corresponding indicator display at each break-point, which is the segment finishing point as shown in Fig 8, can now be entered using the 'in' and 'diSP' sub-functions.

Using the **▲** or **▼** button select 'in' from the sub-menu and press **P** which will reveal the starting point for the first segment '0 : n', where n is the total number of break-point entered. Press **P** and use the **▲** and **▼** buttons and the **P** button to move between digits, to enter the input current at which the first break-point is required, usually 4.000mA. When set as required, press **E** to return to the '0 : n' prompt from which the the next break-point can be selected using the **▲** and **▼** buttons. When the required break-point has been selected press **P** and enter the indicator input current at this break-point. Repeat this procedure until the indicator input current at all the the break-points has been defined and then return to the 'in' sub-function by pressing the **E** button.

The corresponding indicator display at each of the break-points can now be defined using the 'diSP' sub-function. Using the **▲** and **▼** buttons select the 'diSP' sub-function and press **P** which will reveal the starting point for the first break-point '0 : n', where n is the total number of break-points entered. Press **P** and use the **▲** and **▼** buttons and the **P** button to move between digits, to enter the required indicator display at the first break-point. When set as required, press **E** to return to the '0 : n' prompt from which the the next break-point can be selected using the **▲** or **▼** buttons. When the required break-point has been selected press **P** and set the required indicator display at this break-point.

Repeat this procedure until the indicator display at all the break-points has been defined and then return to the 'SEt' function in the configuration menu by pressing the **E** button twice.

7.3 Lineariser error message

If an attempt is made to position a break-point at a current which is not greater than the current of the preceeding break-point, or at a current which is not less than the current of the following break-point, the error message 'Fail' will be displayed. This error message will also be displayed if an attempt is made to position a break-point outside the current range 3.8 to 21.0mA.

7.4 Under and over-range

The lineariser does not change the under and over-range indication described in section 6.12. At input currents below that specified for the first break-point (0), the indicator will continue to use the specified slope of the first segment. Although not guaranteed, most indicators will continue to function normally with an input current between 1.8mA and 4mA, at lower currents the instrument will display 'LPLo' before it stops functioning.

At input currents above that specified for the last break-point, the indicator will continue to use the slope specified for the last lineariser segment.

7.5 Lineariser default configuration

When the lineariser is reset to the default conditions using the 'rSEt' reset function described in section 6.11, the defaults conditions are:

	BA304E	BA324E
First break-point 4mA	0.0	0.00
Second break-point 20mA	100.0	100.00

8. MAINTENANCE

8.1 Fault finding during commissioning

If an indicator fails to function during commissioning the following procedure should be followed:

Symptom	Cause	Solution
No display	Incorrect wiring	Check wiring There should be 0.6 to 1.2V between terminals 1 & 3 with terminal 1 positive. With an optional backlight loop powered, there should be 3.4 to 5V between terminals 3 & 12 with terminal 12 positive.
No display 0V between terminals 1 & 3.	Incorrect wiring or no power supply	Check supply voltage and voltage drop caused by all the instruments in the loop.
All decimal points flashing.	Underrange if -ve sign displayed or overrange.	Recalibrate the numerical display.
Unstable display	4/20mA input is noisy.	Eliminate ripple on 4/20mA power supply and/or decrease indicator resolution.
Unable to enter configuration menu.	Incorrect security code entered.	Enter correct security code, or contact BEKA if the code has been lost.

8.2 Fault finding after commissioning

ENSURE PLANT SAFETY BEFORE STARTING MAINTENANCE

Live maintenance is permitted on intrinsically safe equipment installed in a gas hazardous area, but only certified test equipment should be used unless a gas clearance certificate is available.

If an indicator fails after it has been functioning correctly follow the procedure shown in section 8.1. If this does not reveal the cause of the fault, it is recommended that the instrument is replaced. This can be done without disconnecting power, but while the indicator is disconnected the 4/20mA loop will be open circuit.

8.3 Servicing

All BA304E and BA324E loop powered indicators are interchangeable if the required optional backlight and alarms are fitted. A single spare instrument may quickly be recalibrated to replace any instrument that is damaged or fails. No attempt should be made to repair instruments at component level.

We recommend that faulty instruments are returned to BEKA associates or to your local BEKA agent for repair.

8.4 Routine maintenance

The mechanical condition of the instrument and electrical calibration should be regularly checked. The interval between inspections depends upon environmental conditions. We recommend that initially instrument calibration should be checked annually.

8.5 Guarantee

Indicators which fail within the guarantee period should be returned to BEKA associates or our local agent. It is helpful if a brief description of the fault symptoms is provided.

8.6 Customer comments

BEKA associates is always pleased to receive comments from customers about our products and services. All communications are acknowledged and whenever possible, suggestions are implemented.

9. ACCESSORIES

9.1 External keypad

The four indicator push buttons are located behind the instrument control cover, for applications requiring frequent adjustment an optional control cover fitted with an external keypad is available. This keypad maintains the enclosure ingress protection and accidental push button activation can be prevented by use of a menu security access code, see section 6.10.

9.2 Units measurement & instrument identification.

Both the BA304E and the BA324E indicators are fitted with a blank escutcheon around the liquid crystal display. This can be supplied printed with any units of measurement and tag information specified at the time of ordering. Alternatively, the information may be added on-site via an embossed strip, dry transfer or a permanent marker.

To gain access to the display label remove the terminal cover by unscrewing the two 'A' screws which will reveal two concealed 'D' screws. If the instrument is fitted with external keypad, also unscrew the two 'C' screws securing the buttons and un-plug the five way connector. Finally unscrew all four 'D' screws and carefully lift off the front of the instrument. The location of all the screws is shown in Fig 4.

Add the required legend to the display escutcheon, or stick a new pre-printed self-adhesive escutcheon, which is available from BEKA associates, on top of the existing escutcheon. Do not remove the original escutcheon.

Both indicators can also be supplied with a blank or custom laser engraved stainless steel plate secured by two screws to the front of the instrument enclosure. This plate can accommodate:

1 row of 9 alphanumeric characters 10mm high

or 1 row of 11 alphanumeric characters 7mm high

or 2 rows of 18 alphanumeric characters 5mm high

9.3 Alarms

CAUTION

These alarms outputs should not be used for critical safety applications such as an emergency shut down system.

Both models can be supplied with factory fitted dual solid state, single pole alarm outputs. Each alarm output may be independently conditioned as a high or low alarm with a normally open or normally closed output in the non-alarm condition.

When the 4/20mA current powering the indicator is removed both alarm outputs will open irrespective of configuration. The open circuit condition should therefore be chosen as the alarm condition when designing an alarm system. Fig 9 illustrates the conditions available and shows which are fail safe.

When an alarm occurs an alarm annunciator on the indicator front panel is activated and if required the numerical display can alternate between the measured value and the alarm channel identification 'ALr1' or 'ALr2'.

CAUTION

The alarms are activated by the indicator's numerical display. Use of the Tare Function 'tArE' will change the numerical display, the alarms will continue to function at the original displayed value, but this will correspond to a different input current.

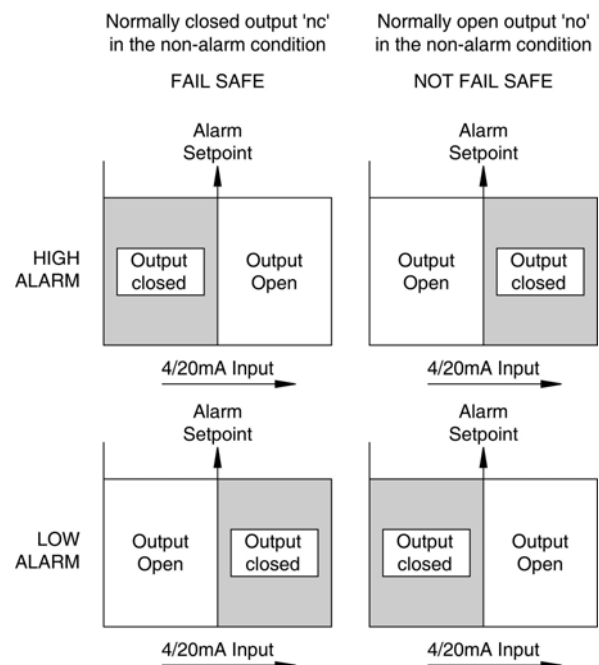

Fig 9 Alarm outputs

Configurable functions for each alarm include adjustable setpoint, hysteresis, alarm delay and alarm accept.

9.3.1 Solid state output

Each alarm has a galvanically isolated single pole solid state switch output which as shown in Fig 10. The output is polarised and current will only flow in one direction.

$$\begin{aligned} R_{on} &= \text{less than } 5\Omega + 0.7V \\ R_{off} &= \text{greater than } 1M\Omega \end{aligned}$$

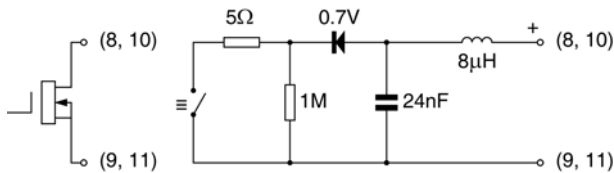

Fig 10 Equivalent circuit of each alarm output

9.3.2 Intrinsic safety

Each alarm output is a separate galvanically isolated intrinsically safe circuit. The EC-Type Examination Certificate states that for intrinsic safety considerations, under fault conditions the output voltage, current and power at terminals 8 & 9 and 10 & 11 will not exceed those specified by clause 5.7 of EN 60079-11 for *simple apparatus*. This simplifies system documentation and allows the alarm output terminals 8 & 9 and 10 & 11 to be connected to almost any intrinsically safe circuit protected by a Zener barrier or galvanic isolator providing the output parameters of the circuit do not exceed:

$$\begin{aligned} U_o &= 30V \text{ dc} \\ I_o &= 200mA \\ P_o &= 0.84W \end{aligned}$$

The maximum equivalent capacitance and inductance between each set of alarm terminals is:

$$\begin{aligned} C_i &= 24nF \\ L_i &= 8\mu H \text{ (Effectively 0)} \end{aligned}$$

To determine the maximum permissible cable capacitance C_i should be subtracted from the maximum permitted cable capacitance specified by the certificate powering the alarm circuit, such as the solenoid driver and switch transfer galvanic isolators shown in Fig 11.

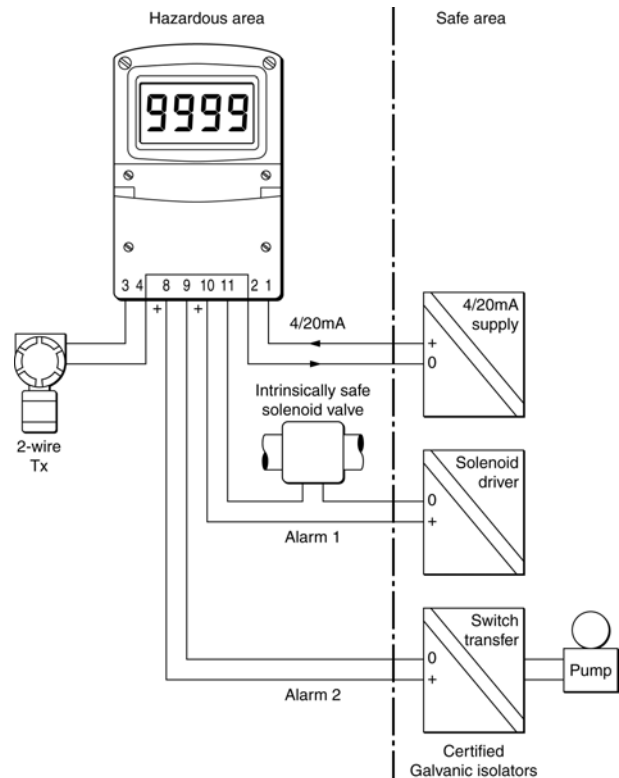

Fig 11 Typical alarm application
(Shown without recommended screened cables)

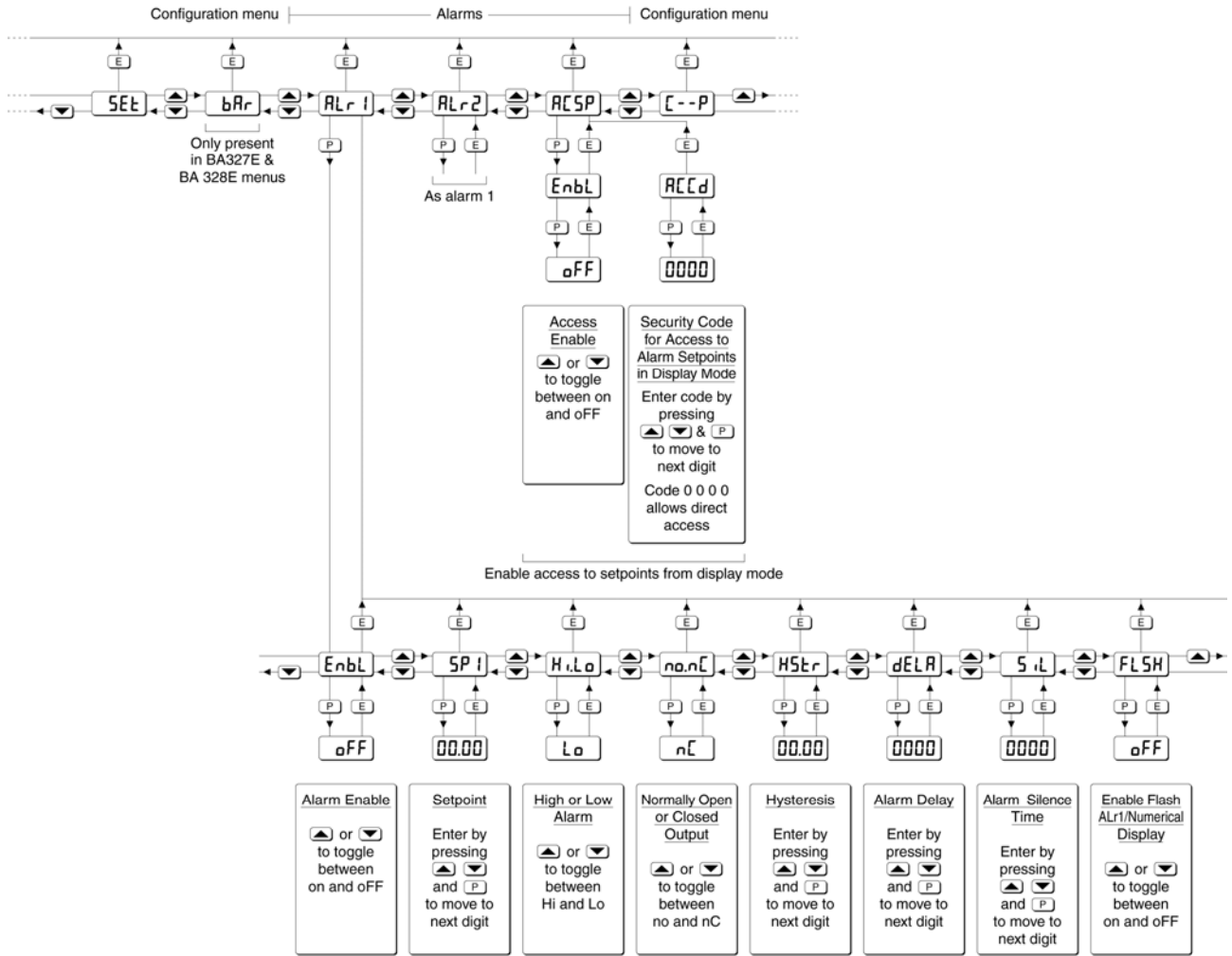

Fig 12 Alarm Configuration Functions in Configuration Menu

9.3.3 Configuration and adjustment

When optional alarms are fitted to a loop powered indicator the configuration menu is extended as shown in Fig 12. The additional functions appear between the 'SEt' and the 'C- - P' functions for the BA304E and between 'bAr' and 'C- -P' for the BA324E indicator. For simplicity, Fig 12 only shows the additional functions for alarm 1, but alarm 2 has identical functions.

The following table summaries each of the alarm configuration functions and includes a cross reference to more detailed information. Again only the functions on Alarm 1 are listed, but alarm 2 has identical facilities.

Summary of alarm configuration functions

Display	Description of function
'EnbL'	Alarm enable Enables or disables the alarm without changing the alarm parameters. See section 9.3.4
'SP1'	Alarm setpoint 1 Adjusts the alarm setpoint. The alarm is activated when the indicator display equals the setpoint. See section 9.3.5
'Hi.Lo'	Alarm function Defines the alarm function as High or Low. See section 9.3.6
'no.nC'	Normally open or normally closed output Sets the alarm output open or closed in the non-alarm condition. See section 9.3.7
'HStr'	Hysteresis Adjusts the alarm hysteresis. See section 9.3.8
'dELA'	Alarm delay time Introduces adjustable delay between the display equalling the setpoint and the alarm output being activated. See section 9.3.9
'SiL'	Alarm silence time Defines the time that the alarm output remains in the non-alarm condition following acceptance of an alarm. See section 9.3.10
'FLSH'	Flash display when alarm occurs When enabled, alternates the numerical display between process value and alarm reference, 'ALr1' or 'ALr2', when an alarm output is activated. See section 9.3.11
'ACSP'	Access setpoint Sub-menu which enables direct access to the alarm setpoints from the indicator display mode, and defines a separate security code. See section 9.3.12

9.3.4 Alarm enable: 'EnbL'

This function allows each alarm to be enabled or disabled without altering any of the alarm parameters. To enable or disable the alarm select 'EnbL' from the alarm menu and press **P** which will reveal the current setting 'on' or 'oFF'. The function can be changed by pressing the **▲** or **▼** button followed by the **E** button to return to the alarm menu.

9.3.5 Setpoint adjustment: 'SP1' and 'SP2'

The setpoint of each alarm may be positioned anywhere in the numerical display of the indicator providing that this corresponds to an input current between 3.8 and 20.2mA. e.g. If the indicator has been calibrated to display 0 with 4mA input and 10000 with 20mA input, the two alarm setpoints may be positioned anywhere between -125 and 10125.

To adjust the setpoint select 'SP1' or 'SP2' from the alarm configuration menu and press **P** which will reveal the existing alarm setpoint. The flashing digit of the setpoint can be adjusted using the **▲** and **▼** push-buttons, and the **P** button to move control to the next digit. When the required setpoint has been entered press **E** to return to the alarm configuration menu.

The alarm setpoints may also be adjusted when the indicator is in the display mode, see section 9.3.12.

9.3.6 Alarm function: 'Hi.Lo'

Each alarm can be independently conditioned as a high alarm or as a low alarm. To check or change the alarm function select 'Hi.Lo' from the alarm menu and press **P** to reveal the current setting. The function can be changed by pressing the **▲** or **▼** button followed by the **E** button to return to the alarm menu.

9.3.7 Alarm output status: 'no.nC'

Configures the solid state alarm output to be open 'no' or to be closed 'nC' in the non-alarm condition. When deciding which is required, care should be taken to ensure that the alarm output is fail safe as illustrated in Fig 9.

'no' Alarm output open in non-alarm condition

'nC' Alarm output closed in non-alarm condition

CAUTION

When the 4/20mA supply is removed from the loop powered indicator, both alarm outputs will open irrespective of conditioning. Therefore for fail safe operation both alarm outputs should be conditioned to be open in the alarm condition 'nC'.

To check or change the alarm output status, select 'no.nC' from the alarm configuration menu and press **P** to reveal the setting. The function may be changed by pressing the **▲** or **▼** button followed by the **E** button to return to the alarm configuration menu.

9.3.8 Hysteresis: HStr

Hysteresis is shown in the units that the indicator has been calibrated to display.

To adjust the hysteresis select 'HStr' from the alarm menu and press **P** which will reveal the existing figure. The flashing digit can be adjusted using the **▲** and **▼** push-buttons, and the **P** button will move control to the next digit. When the required hysteresis has been entered press **E** to return to the alarm configuration menu.

e.g. An indicator calibrated to display 0 to 10000, with a high alarm set at 9000 and hysteresis of 200 will perform as follows:

The high alarm will be activated when increasing indicator display equals 9000, but will not reset until the indicator display falls below 8800.

9.3.9 Alarm delay: dELA

This function delays activation of the alarm output for an adjustable time following the alarm condition occurring. The delay can be set in 1 second increments between 0 and 3600 seconds. If a delay is not required zero should be entered. To adjust the delay select 'dELA' from the alarm configuration menu and press **P** which will reveal the existing delay. The flashing digit of the delay can be adjusted using the **▲** and **▼** push-buttons, and the **P** button to move control to the other digits. When the required delay has been entered press **E** to return to the alarm menu.

e.g. An indicator with a high alarm set at 9000 and an alarm delay of 30 seconds will perform as follows:

The alarm annunciator will start to flash when an increasing indicator display equals 9000, but the alarm output will not be activated until the alarm condition has existed continuously for 30 seconds. When the alarm output is activated, the alarm annunciator will stop flashing and become permanently activated.

If the 'FLSH' function, which flashes the indicator display when an alarm occurs, has been enabled, it will not start to function until the alarm output is activated.

See section 9.3.11

9.3.10 Alarm silence time: SiL

This function is primarily intended for use in small installations where the alarm output directly operates an alarm annunciator such as a sounder or beacon. When the alarm silence time, which is adjustable between 0 and 3600 seconds in 1 second increments, is set to any figure other than zero, the **P** push-button becomes an alarm accept button. After an alarm has occurred, operating the **P** button will cause the alarm output to revert to the non-alarm condition for the programmed alarm silence time. If the alarm condition still exists at the end of the silence time, the alarm output will be reactivated. During the silence time the indicator alarm annunciator will flash until the silence time expires or the alarm is cleared.

If the 'FLSH' function, which flashes the indicator display when an alarm occurs has been enabled, it will only function when the alarm output is activated, not during the silence time. See section 9.3.11

To adjust the alarm silence time select 'SiL' from the alarm configuration menu and press **P** which will reveal the existing silence time. The flashing digit of the silence time can be adjusted using the **▲** and **▼** push-buttons, and the **P** button to move control to the other digits. When the required silence time has been entered press **E** to return to the alarm menu.

9.3.11 Flash display when alarm occurs 'FLSH'

In addition to the two alarm annunciators on the top left hand corner of the indicator display which show the status of both alarms, this function provides an even more conspicuous indication that an alarm condition has occurred.

When enabled, the function alternates the indicator display between the numerical value and the alarm reference, 'ALr1' or 'ALr2', when the alarm output is activated. If both alarm outputs are activated, the alarm references are displayed in sequence.

To enable or disable the function select 'FLSH' from the alarm menu and press **P** which will reveal the current setting 'on' or 'off'. The function can be changed by pressing the **▲** or **▼** button followed by the **E** button to return to the alarm menu.

9.3.12 Access setpoint in display mode: ACSP

This function enables a separate menu providing access to the alarm setpoints from the display mode by simultaneously operating the **P** and **▲** push-buttons. An operator can therefore adjust the alarm setpoints without having access to the indicator configuration menu. Protection against accidental adjustment of the setpoints when the

indicator is in the display mode is provided by a separate security code.

This direct setpoint access menu is enabled and the separate security code entered from the 'ACSP' function in the alarm configuration menu as shown in Fig 12. To change the menu parameters select 'ACSP' from the configuration menu and press **P** which will display the enable prompt 'EnbL'. Press **P** again to reveal if the direct access menu is 'on' or 'off'. The **▲** or **▼** button will toggle the display between the two conditions.

If 'off' is selected, the operator will not have access to the setpoints from the display mode. Return to the 'ACSP' prompt in the main menu by pressing **E** twice.

If 'on' is selected, the operator will have direct access to the alarm setpoints from the display mode via a separate optional security code. To define this four digit security code press **P** to return to the 'EnbL' prompt followed by the **▲** or **▼** button to select the access code prompt 'ACCd'. Pressing **P** will reveal the current security code. Each digit of the code may be changed by operating the **▲** and **▼** push-buttons, and the **P** button to move control to the next digit. When the required code has been entered, press **E** twice to return to the 'ACSP' prompt in the configuration menu.

Default code 0000 will disable the security code allowing direct access to the setpoints in the display mode by pressing the **P** and **▲** buttons simultaneously. Unless otherwise requested new instruments with alarms are supplied with this function disabled and the security code set to 0000.

9.3.13 Adjusting alarm setpoints from the display mode

Access to the alarm setpoints from the indicator display mode is obtained by operating the **P** and **▲** push-buttons simultaneously as shown in Fig 13. If the setpoints are not protected by a security code the alarm setpoint prompt 'SP1' will be displayed. If the setpoints are protected by a security code, 'Code' will be displayed first. Pressing **P** again will enable the alarm security code to be entered digit by digit using the **▲** and **▼** buttons to change the flashing digit, and the **P** push-button to move control to the next digit. If the correct code is entered pressing **E** will cause alarm setpoint prompt 'SP1' to be displayed. Pressing the **▲** or **▼** button will toggle the display between the two alarm setpoint prompts 'SP1' and 'SP2'.

If an incorrect security code is entered, or a button is not pressed within twenty seconds, the indicator will automatically return to the display mode.

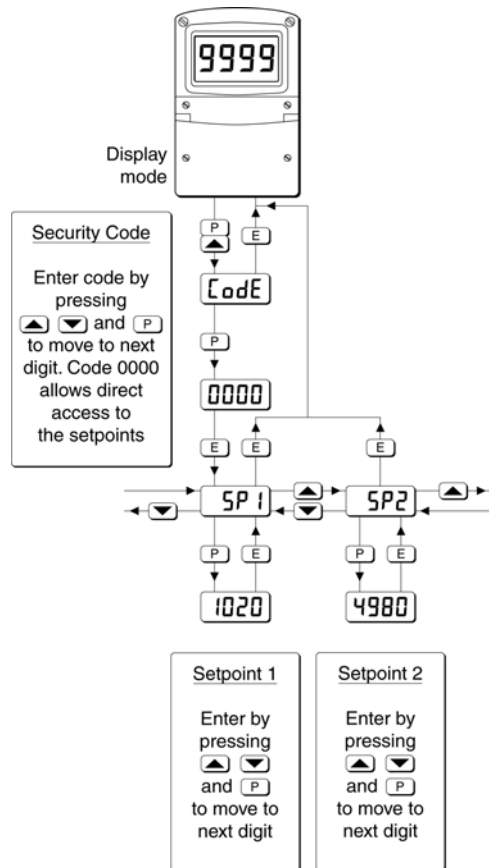

Fig 13 Setpoint adjustment from the display mode

To adjust an alarm setpoint select 'SP1' or 'SP2' and press **P** which will reveal the current setting. Each digit of the setpoint may be adjusted using the **▲** and **▼** push-buttons, and the **P** button to move control to the next digit. When the required setpoint has been entered, pressing **E** will return the display to the 'SP1' or 'SP2' prompt from which the other setpoint may be selected, or the indicator may be returned to the display mode by pressing **E** again.

Note: With the indicator in the display mode, direct access to the alarm setpoints is only available when the ACSP menu is enabled - see section 9.3.12

9.3.14 Displaying setpoints on BA324E bargraph

One of the selectable bargraph formats 'AlrSP' allows a low or a high setpoint plus the displayed value to be represented, or a low and a high setpoint plus the displayed value to be represented by the bargraph as shown in Fig 14.

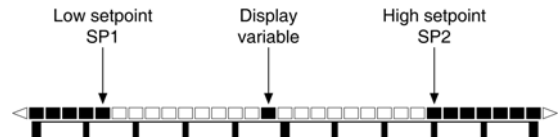

Fig 14 Displayed value and setpoints on bargraph

The bargraph area below the low alarm setpoint and the area above the high alarm setpoint are activated. The displayed variable is represented by an activated bar which moves between these low and high alarm setpoints.

When the activated bar representing the displayed variable is adjacent to the area representing the low or high alarm setpoints, the bar flashes. When a displayed variable equals the low or high alarm the complete bargraph representing the activated alarm flashes irrespective of whether the alarm output has been delayed or cleared.

For this function to operate SP1 must be conditioned as a low alarm and SP2 as a high alarm; SP1 must always be less than SP2. Incorrect configuration is shown by a flashing bargraph scale with no activated bars.

9.4 Display backlight

The BA304E and BA324E loop powered indicators can be supplied with a factory fitted backlight that may be loop or separately powered.

When loop powered the backlight produces green background illumination enabling the display to be read at night or in poor lighting conditions. No additional power supply, intrinsic safety interface or field wiring are required, but the indicator voltage drop is increased. When separately powered the backlight is brighter, but an additional intrinsic safety interface and field wiring are required.

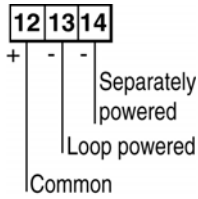

Fig 15 Terminals for optional backlight

9.4.1 Loop powering the backlight

The backlight is loop powered by connecting it in series with the indicator's 4/20mA input as shown in Fig 16, which increases the maximum indicator voltage drop from 1.2 to 5V.

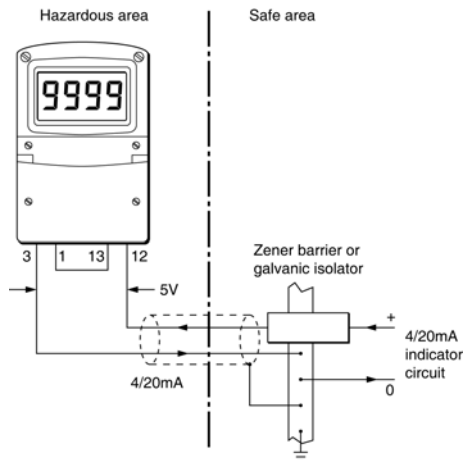

Fig 16 Loop powered backlight

The input intrinsic safety parameters of the combined indicator and backlight are the same as for the indicator alone. The EC-Type Examination Certificate states that for intrinsic safety considerations, under fault conditions the output voltage, current and power of the combined indicator and backlight terminals 12 & 3 will not exceed those specified by clause 5.7 of EN 60079-11 for *simple apparatus*, which simplifies system design and documentation.

Providing the increased voltage drop can be tolerated the intrinsic safety and system design described in sections 3 and 4 of this manual remain valid with the backlight loop powered.

9.4.2 Separately powering the backlight

The optional backlight may also be powered from a separate safe area power supply via an intrinsically safe interface as shown in Fig 16.

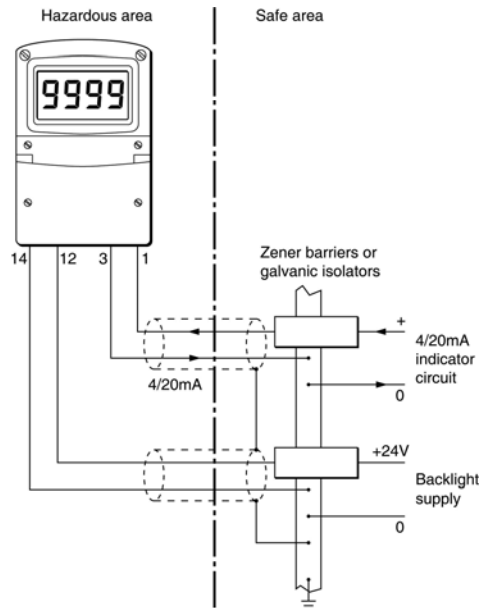

Fig 17 Separately powered backlight

When separately powered the backlight draws a constant current when the supply is equal to or greater the minimum specified voltage. Below this supply voltage the backlight continues to function but with reduced brilliance.

	Current	Minimum voltage
BA304E & BA324E	34.7mA	11V

Any certified Zener barrier or galvanic isolator may be used, providing the output parameters do not exceed:

$$\begin{aligned}
 U_o &= 30V \text{ dc} \\
 I_o &= 200mA \\
 P_o &= 0.84W
 \end{aligned}$$

The internal capacitance C_i between terminals 12 & 14 should be subtracted from C_o of the intrinsically safe interface powering the backlight to determine the maximum permissible cable capacitance.

$$\begin{aligned}
 C_i &= 13nF \\
 l_i &= 8\mu H \text{ (Effectively 0)}
 \end{aligned}$$

The separately powered backlight is a current sink which will draw a constant 35mA when the voltage between terminal 12 and 14 is greater than 11V. If the supply voltage is less than 11V the backlight brilliance will be reduced.

9.5 Pipe mounting kits

Two pipe mounting kits are available for securing the BA304E and BA324E to a horizontal or vertical pipe.

- BA392D Stainless steel bracket secured by two worm drive hose clips. Will clamp to any vertical or horizontal pipe with an outside diameter between 60 and 80mm.
- BA393 Heavy duty stainless steel bracket secured by a single 'V' bolt. Will clamp to any vertical or horizontal pipe with an outside diameter between 40 and 80mm.

Appendix 1 ATEX Dust Certification

A1.0 ATEX dust certification

In addition to ATEX certification permitting installation in explosive gas atmospheres which is described in the main section of this instruction manual, the BA304E and the BA324E are available with ATEX dust certification. Dust certification is an option which must be specified when the indicator is ordered.

CAUTION

Before installing a BA304E or BA324E indicator in the presence of a combustible dust atmosphere, ensure that the certification information label which is located on the top of the instrument specifies dust certification - see section A1.2

A1.1 Zones, and Maximum Surface Temperature

The BA304E and the BA324E have been ATEX certified as Group II, Category 1D Ex ia IIIC T80°C Da IP66 Ta = -40 to 70°C. When installed as specified by EN 61241-14 the indicators may be installed in:

- Zone 20 explosive atmosphere in the form of a cloud of combustible dust in air is continuously present, or for long periods or frequently.
- Zone 21 explosive atmosphere in the form of a cloud of combustible dust in air is likely to occur occasionally in normal operation.
- Zone 22 explosive atmosphere in the form of a cloud of combustible dust in air is not likely to occur in normal operation, but if it does occur, will only persist for a short period.

Be used with dust in subdivisions:

- IIIA combustible flyings
- IIIB non-conductive dust
- IIIC conductive dust

Having a Minimum Ignition Temperature of:

- | | |
|--------------------------------------------|-------------------------|
| Dust cloud | 120°C |
| Dust layer on indicator
up to 5mm thick | 155°C |
| Dust layer on indicator
over 5mm thick. | Refer to
EN 61241-14 |

At an ambient temperature between -40 and +70°C

A1.2 Certification Label Information

The certification label is fitted in a recess on the top outer surface of the enclosure. It shows the ATEX dust certification information including the maximum surface temperature and ingress protection, plus the ATEX gas certification information. Non European information may also be shown.



BA304E label including dust certification



BA324E label including dust certification

The instrument serial number and date of manufacture are recorded on a separate label inside the terminal compartment.

A1.3 Installation and maintenance

The indicator's ATEX intrinsic safety dust certification relies on the ingress protection provided by the instrument enclosure to prevent dust accumulating on the field terminals and internal switches. Therefore the control and terminal covers should only be removed when dust can not enter the instrument enclosure. Before replacing the control and terminal covers the sealing gaskets should be inspected to ensure that they are undamaged and are free from foreign bodies.

Appendix 2 IECEX certification

A2.0 The IECEx Certification Scheme

IECEX is a global certification scheme for explosion protected products which aims to harmonise international certification standards. For additional information about the IECEx certification scheme and to view the BEKA associate certificates, please visit www.iecex.com

A2.1 IECEx Certificate of Conformity

The BA304E and the BA324E loop powered indicators and the optional accessories have been issued with an IECEx Certificate of Conformity number IECEx ITS 11.0014 which specifies the following certification codes:

Ex ia IIC T5 Ga
Ex ia IIIC T80°C Da IP66 *
Ta = -40°C to 70°C

* *IECEX dust certification is an option, which if required should be specified when the indicator is ordered.*

The specified IECEx gas and dust intrinsic safety parameters are identical to the ATEX safety parameters described in the main section and Appendix 1 of this manual.

The IECEx certificate may be downloaded from www.beka.co.uk, www.iecex.com or requested from the BEKA sales office.

A2.2 Installation

The IECEx and ATEX certificates specify identical safety parameters and installation requirements for both approvals as defined by IEC 60079-14. The ATEX installation requirements specified in the main section and Appendix 1 of this manual may therefore be used for IECEx installations, but the local code of practice should also be consulted.

A2.3 Versions of the BA304E

All versions of the BA304E and BA324E loop powered indicators have IECEx certification.

This includes:

ATEX version for use in gas atmospheres.

IECEX code Ex ia IIC T5 Ga
Ta = -40°C to 70°C

ATEX version for use in gas and dust atmospheres.

IECEX code Ex ia IIC T5 Ga
Ex ia IIIC T80°C Da IP66
Ta = -40°C to 70°C

CAUTION

Before installing a BA304E or BA324E indicator in the presence of a combustible dust atmosphere, ensure that the certification information label which is located on the top of the instrument specifies dust certification, see section A1.2

Appendix 3
FM Approval for use in the USA and
cFM Approval for use in Canada

A3.0 Factory Mutual Approval

For installations in the USA and Canada, versions of the BA304E and BA324E are available with FM and cFM intrinsic safety and nonincendive approval, project identifications 3041487 and 3041487C. Copies of the Certificates of Compliance are available from the BEKA associates sales office and www.beka.co.uk

The FM and cFM Approved indicators are identical to the ATEX & IECEx certified versions except the three M20 x 1,5 tapped cable entries are replaced by three plain unthreaded 22.25mm diameter entries. Approved hubs and glands are listed in note 7 of Intrinsically Safe Control Drawing CI300-72 and note 5 of Nonincendive Control Drawing CI300-73. The certification label on the FM and cFM Approved versions also includes ATEX and IECEx gas certification information so that the indicators may also be used in systems covered by either authority.

A3.1 Intrinsic safety approval

The BA304E and BA324E indicators are approved to FM Class 3610 intrinsic safety standard for use in Division 1 and 2 hazardous (classified) locations. Installations must comply with BEKA associates Control Drawing CI300-72, which is attached to this Appendix, ANSI/ISA RP12.06.01 'Installation of Intrinsically Safe Systems for Hazardous (Classified) Locations' and with the National Electrical Code ANSI/NFPA70. Installations in Canada must comply with the Canadian Electrical Code C22.2

The BA304E and BA324E have T5 rating at ambient temperatures up to +70°C and may be used with the following gases and dusts:

Intrinsic Safety	
Division 1 or 2	
Class I	Group A & B Group C Group D
Class II	Group E, F & G
Class III	
Zone 0, 1 or 2	
Class 1	Group IIC Group IIB Group IIA

The FM and cFM entity parameters are similar to the ATEX and IECEx parameters and the systems shown in section 4 of this manual may therefore also be used for FM and cFM installations.

A3.2 Nonincendive approval

The BA304E and BA324E indicators are also approved to nonincendive standard FM Class 3611 allowing installation in Division 2 hazardous (classified) locations without the need for Zener barriers or galvanic isolators. US installations must comply with the BEKA associates Control Drawing CI300-73, which is attached to this Appendix, and with the National Electrical Code ANSI/NFPA70.

Canadian nonincendive installations must comply with the Canadian Electrical Code C22.2 and with BEKA associates Control Drawing CI300-73, which is attached to this Appendix.

The BA304E and BA324E have a T5 rating at ambient temperatures up to +70°C and may be used with the following gases and dusts:

Nonincendive	
Division 2	
Class I	Group A & B Group C Group D
Class II	Groups E, F & G
Class III	
Zone 2	
Class I	Group IIC Group IIB Group IIA

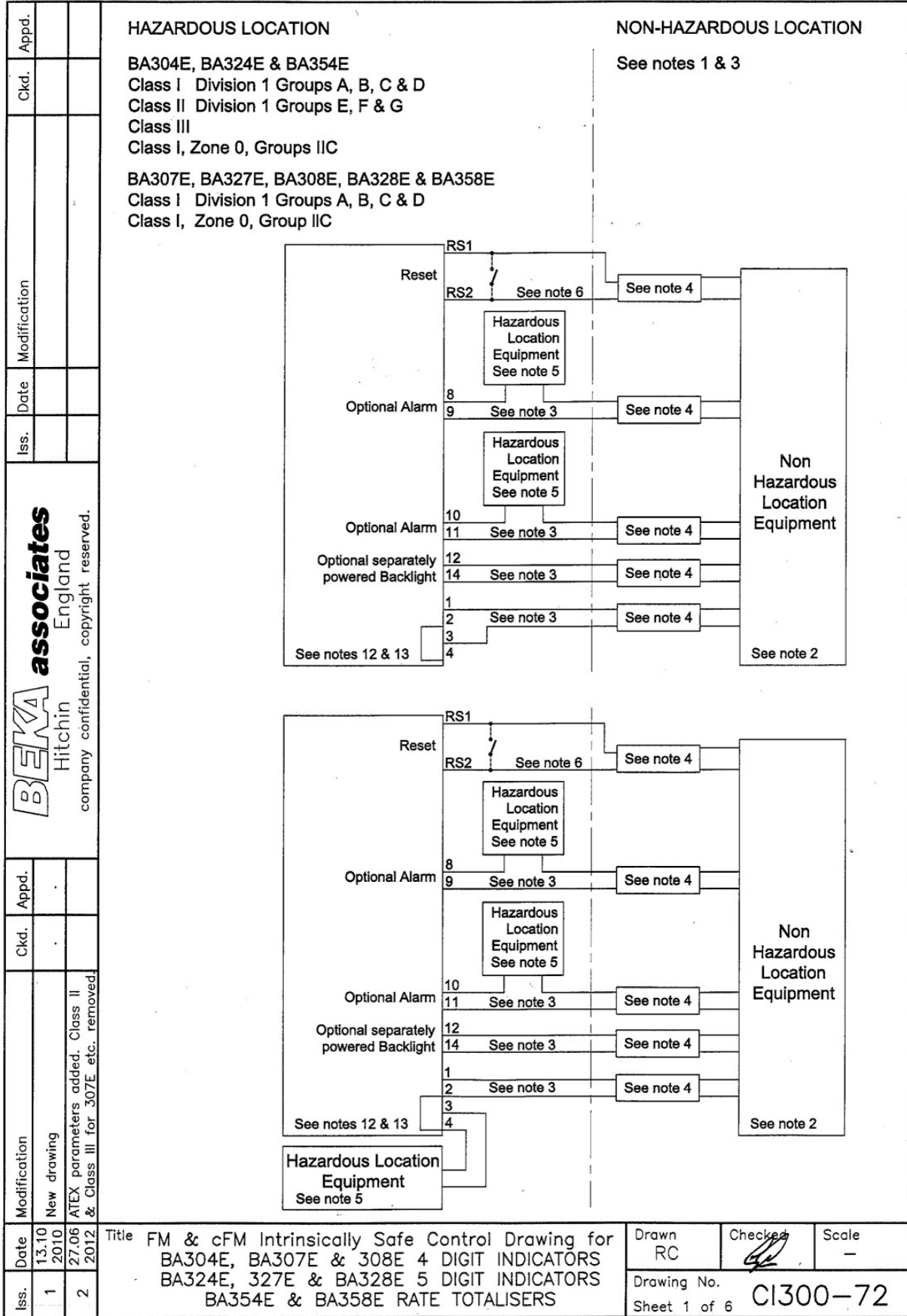

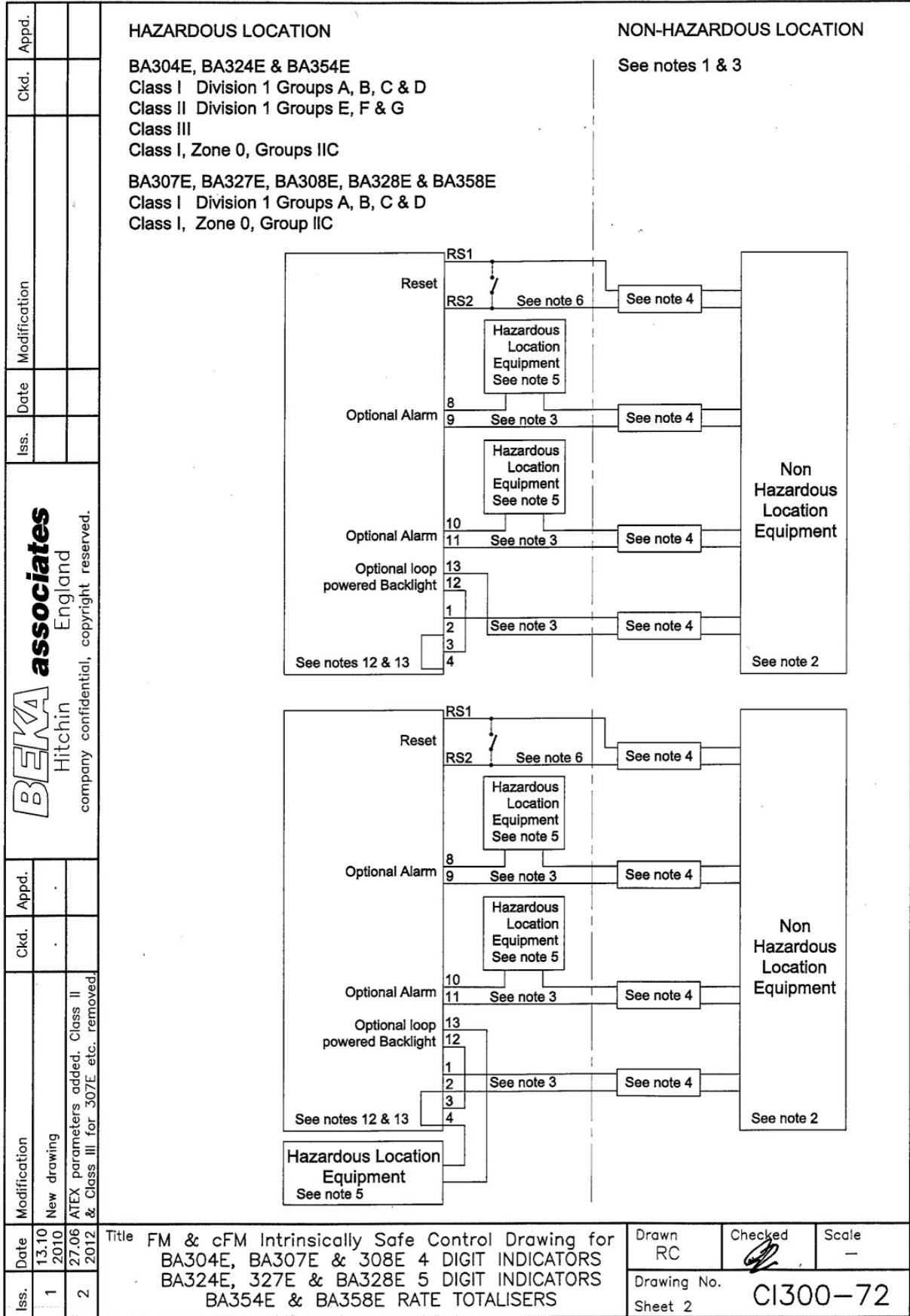

Title FM & cFM Intrinsically Safe Control Drawing for
 BA304E, BA307E & 308E 4 DIGIT INDICATORS
 BA324E, 327E & BA328E 5 DIGIT INDICATORS
 BA354E & BA358E RATE TOTALISERS

Drawn RC	Checked 	Scale -
Drawing No. Sheet 2		CI300-72

Iss.		Date		Modification		Ckd.		Appd.			
1		13.10.2010		New drawing							
2		27.06.2012		ATEX parameters added. No change to this sheet							
<p>BEKA associates Hitchin England company confidential, copyright reserved.</p>											
<p>Notes</p> <ol style="list-style-type: none"> The associated protective barriers and galvanic isolators shall be FM approved and the manufacturers instructions shall be followed when installing this equipment. For installations in Canada the associated protective barriers and galvanic isolators shall be cFM or CSA approved and the manufacturers installation drawings shall be followed when installing this equipment. The unclassified location equipment shall not use or generate more than 250V rms or 250V dc. Installations shall be in accordance with ANSI/ISA RP 12.06.01 'Installation of Intrinsically Safe Systems for Hazardous (Classified) Locations' and the National Electrical Code ANSI/NFPA 70. Installations in Canada shall be in accordance with the Canadian Electrical Code C22.2. One single channel or one two channel associated protective barrier or galvanic isolator with entity parameters complying with the following requirements: <ul style="list-style-type: none"> Uo equal or less than The lowest Ui of the FM, cFM or CSA approved apparatus installed in the loop. Io equal or less than The lowest Ii of the FM, cFM or CSA approved apparatus installed in the loop. Po equal or less than The lowest Pi of the FM, cFM or CSA approved apparatus installed in the loop. Lo equal or greater than The sum of the cable inductances and the internal inductances Li of each FM, cFM or CSA approved apparatus in the loop. Co equal or greater than The sum of the cable capacitance and the internal capacitance Ci of each FM, cFM or CSA approved apparatus in the loop. 											
Iss.		Date		Title		Drawn		Checked		Scale	
1		13.10.2010		FM & cFM Intrinsically Safe Control Drawing for BA304E, BA307E & 308E 4 DIGIT INDICATORS		RC				-	
2		27.06.2012		BA324E, 327E & BA328E 5 DIGIT INDICATORS BA354E & BA358E RATE TOTALISERS		Drawing No.		Sheet 3		CI300-72	

Iss.		Date		Modification		Ckd.		Appd.	
1		13.10.2010							
2		27.06.2012		ATEX parameters added. No change to this sheet					

BEKA associates
Hitchin
England
company confidential, copyright reserved.

5. Simple Apparatus as defined in the National Electrical Code ANSI/NFPA 70, or for installations in Canada by the Canadian Electrical Code C22.2 OR:

Ui equal or greater than The highest U_o of the FM, cFM or CSA approved apparatus powering the loop.

li equal or greater than The highest I_o of the FM, cFM or CSA approved apparatus powering the loop.

Pi equal or greater than The highest P_o of the FM, cFM or CSA approved apparatus powering the loop.

Lo of the FM, cFM or CSA approved apparatus powering the loop equal or greater than The sum of the cable inductances and the internal inductances L_i of each FM, cFM or CSA approved apparatus in the loop.

Co of the FM, cFM or CSA approved apparatus powering the loop equal or greater than The sum of the cable capacitances and the internal capacitances C_i of each FM, cFM or CSA approved apparatus in the loop.

6. Reset terminals RS1 and RS2 are only fitted to BA354E and BA358E Rate Totalisers. They may be connected to one single channel or one two channel associated protective barrier or galvanic isolator as defined in note 4. And / or to a single pole switch complying with requirements for simple apparatus as defined in the National Electrical Code ANSI/NFPA 70, or for installations in Canada by the Canadian Electrical Code C22.2.

7. When installed in a hazardous (classified) location the BA304E and BA324E field mounting Indicators and the BA354 field mounting Rate Totaliser shall be fitted with cable glands / conduit hubs selected from the following table .

Metallic glands and hubs must be grounded.



Class	Permitted gland or conduit hub
Class I	Any metallic or plastic cable gland or conduit hub that provides the required environmental protection.
Class II and III	Crouse – Hinds Myler hubs ST-1 STA-1 SSTG-1 STG-1 STAG-1 MHUB-1 HUB 1 O-Z / Gedrey Hubs CHM-50DT CHMG-50DT REMKE hub WH-1-G Killark Glands CMCXAA050 MCR050 MCX050

Date	Title		Drawn	Checked	Scale
13.10.2010	FM & cFM Intrinsically Safe Control Drawing for BA304E, BA307E & 308E 4 DIGIT INDICATORS BA324E, 327E & BA328E 5 DIGIT INDICATORS BA354E & BA358E RATE TOTALISERS		RC		-
27.06.2012			Drawing No.		C1300-72
			Sheet 4		

Iss.		Date	Modification	Ckd.	Appd.
1	13.10	2010			
2	27.06	2012	ATEX parameters added. Note 13 Note 11 should shall 4 places		

 <p>BEKA associates Hitchin England company confidential, copyright reserved.</p>	<p>8. In addition to the supplied bonding plate, when 2 or 3 metallic glands or conduit hubs are fitted to a BA304E or BA324E Indicator or to a BA354E Rate Totaliser, all metallic glands or conduit hubs must be connected together and grounded.</p> <p>9. CAUTION The BA304E, BA307E, BA308E, BA324E, BA327E and the BA328E Indicators and the BA354E and the BA358C Rate Totaliser enclosures are manufactured from conducting plastic per Article 250 of the National Electrical Code.</p> <p>10. The BA304E, BA307E, BA308E, BA324E, BA327E and the BA328E Indicators and the BA354E and the BA358C Rate Totaliser shall be mounted where they are shielded from direct sunlight.</p> <p>11. When mounting the BA307E, BA308E, BA327E and the BA328E panel mounting Indicators and the BA358C panel mounting Rate Totaliser in an enclosure to maintain Type 4 front panel rating:</p> <p style="margin-left: 40px;">Minimum panel thickness should be</p> <p style="margin-left: 120px;">2mm (0.08inches) Steel 3mm (0.12inches) Aluminium</p> <p style="margin-left: 40px;">Outside panel finish should be smooth, free from particles, inclusions, runs or build-ups around cut-out.</p> <p style="margin-left: 40px;">Panel cut-out for BA307E and BA327E shall be:</p> <p style="margin-left: 120px;">90.0 x 43.5mm -0.0 +0.5mm (3.54 x 1.71 inches -0.00 +0.02)</p> <p style="margin-left: 40px;">Two panel mounting clips are required and each shall be tightened to between:</p> <p style="margin-left: 120px;">20 & 22cNm (1.77 to 1.95inLb)</p> <p style="margin-left: 40px;">Panel cut-out for BA308E, BA328E & BA358E shall be:</p> <p style="margin-left: 120px;">66.2 x 136.0mm-0.0 +0.5mm (2.60 x 5.35 inches -0.00 +0.02)</p> <p style="margin-left: 40px;">Four panel mounting clips are required and each shall be tightened to between:</p> <p style="margin-left: 120px;">20 & 22cNm (1.77 to 1.95inLb)</p> <p>12. BA304E, BA307E, BA308E, BA324E, BA327E & BA328E loop powered Indicators and BA354E & BA358E loop powered Rate Totalisers.</p>
---------------------------------------------------------------------------------------------------------------------------------------------------------------------------------	-------------------------------------------------------------------------------------------------------------------------------------------------------------------------------------------------------------------------------------------------------------------------------------------------------------------------------------------------------------------------------------------------------------------------------------------------------------------------------------------------------------------------------------------------------------------------------------------------------------------------------------------------------------------------------------------------------------------------------------------------------------------------------------------------------------------------------------------------------------------------------------------------------------------------------------------------------------------------------------------------------------------------------------------------------------------------------------------------------------------------------------------------------------------------------------------------------------------------------------------------------------------------------------------------------------------------------------------------------------------------------------------------------------------------------------------------------------------------------------------------------------------------------------------------------------------------------------------------------------------------------------------------------------------------------------------------------------------------------------------------------------------------------------------------------------------------------------------------------------------------------------------------------------------------------------------------------------------------------------------------------------------------------------------------------------------------------------------------------------------------------------------------

Title FM & cFM Intrinsically Safe Control Drawing for BA304E, BA307E & 308E 4 DIGIT INDICATORS BA324E, 327E & BA328E 5 DIGIT INDICATORS BA354E & BA358E RATE TOTALISERS		Drawn RC	Checked 	Scale -
		Drawing No. Sheet 5	CI300-72	

Iss.		Date		Modification		Ckd.		Appd.															
1		13.10.2010																					
2		27.06.2012		ATEX parameters added.																			
																							
<p>13. Safety parameters</p> <table border="0" style="width: 100%;"> <tr> <td style="width: 50%; vertical-align: top;"> <p>4/20mA input terminals 1, 2, 3 & 4</p> <p> $U_i = 30V$ $I_i = 200mA$ $P_i = 0.84W$ $U_o = 1.1V$ $I_o = 3mA$ $P_o = 4.5mW$ </p> <p> $C_i = 13nF$ $L_i = 0.01mH$ </p> </td> <td style="width: 50%; vertical-align: top;"> <p>4/20mA input terminals 1, 2, 3, 4, 12 & 13 & loop powered backlight.</p> <p> $U_i = 30V$ $I_i = 200mA$ $P_i = 0.84W$ $U_o = 1.1V$ $I_o = 3mA$ $P_o = 4.5mW$ </p> <p> $C_i = 13nF$ $L_i = 0.01mH$ </p> </td> </tr> <tr> <td style="vertical-align: top;"> <p>Separately powered backlight terminals 12 & 14.</p> <p> $U_i = 30V$ $I_i = 200mA$ $P_i = 0.84W$ </p> <p> $C_i = 13nF$ $L_i = 0.01mH$ </p> </td> <td style="vertical-align: top;"> <p>Alarm terminals 8, 9, 10 and 11</p> <p> $U_i = 30V$ $I_i = 200mA$ $P_i = 0.84W$ $U_o = 1.47V$ $I_o = 1.0\mu A$ $P_o = 2.2\mu W$ </p> <p> $C_i = 24nF$ $L_i = 0.01mH$ </p> </td> </tr> <tr> <td colspan="10"> <p>Reset terminals RS1 & RS2 BA354E & BA358E rate totaliser only.</p> <p> $U_i = 30V$ $I_i = 200mA$ $P_i = 0.84W$ $U_o = 6V$ $I_o = 2.5mA$ $P_o = 3.8mW$ </p> <p> $C_i = 13nF$ $L_i = 0.01mH$ $C_o = 53nF$ $L_o = 0.79mH$ </p> </td> </tr> </table>										<p>4/20mA input terminals 1, 2, 3 & 4</p> <p> $U_i = 30V$ $I_i = 200mA$ $P_i = 0.84W$ $U_o = 1.1V$ $I_o = 3mA$ $P_o = 4.5mW$ </p> <p> $C_i = 13nF$ $L_i = 0.01mH$ </p>	<p>4/20mA input terminals 1, 2, 3, 4, 12 & 13 & loop powered backlight.</p> <p> $U_i = 30V$ $I_i = 200mA$ $P_i = 0.84W$ $U_o = 1.1V$ $I_o = 3mA$ $P_o = 4.5mW$ </p> <p> $C_i = 13nF$ $L_i = 0.01mH$ </p>	<p>Separately powered backlight terminals 12 & 14.</p> <p> $U_i = 30V$ $I_i = 200mA$ $P_i = 0.84W$ </p> <p> $C_i = 13nF$ $L_i = 0.01mH$ </p>	<p>Alarm terminals 8, 9, 10 and 11</p> <p> $U_i = 30V$ $I_i = 200mA$ $P_i = 0.84W$ $U_o = 1.47V$ $I_o = 1.0\mu A$ $P_o = 2.2\mu W$ </p> <p> $C_i = 24nF$ $L_i = 0.01mH$ </p>	<p>Reset terminals RS1 & RS2 BA354E & BA358E rate totaliser only.</p> <p> $U_i = 30V$ $I_i = 200mA$ $P_i = 0.84W$ $U_o = 6V$ $I_o = 2.5mA$ $P_o = 3.8mW$ </p> <p> $C_i = 13nF$ $L_i = 0.01mH$ $C_o = 53nF$ $L_o = 0.79mH$ </p>									
<p>4/20mA input terminals 1, 2, 3 & 4</p> <p> $U_i = 30V$ $I_i = 200mA$ $P_i = 0.84W$ $U_o = 1.1V$ $I_o = 3mA$ $P_o = 4.5mW$ </p> <p> $C_i = 13nF$ $L_i = 0.01mH$ </p>	<p>4/20mA input terminals 1, 2, 3, 4, 12 & 13 & loop powered backlight.</p> <p> $U_i = 30V$ $I_i = 200mA$ $P_i = 0.84W$ $U_o = 1.1V$ $I_o = 3mA$ $P_o = 4.5mW$ </p> <p> $C_i = 13nF$ $L_i = 0.01mH$ </p>																						
<p>Separately powered backlight terminals 12 & 14.</p> <p> $U_i = 30V$ $I_i = 200mA$ $P_i = 0.84W$ </p> <p> $C_i = 13nF$ $L_i = 0.01mH$ </p>	<p>Alarm terminals 8, 9, 10 and 11</p> <p> $U_i = 30V$ $I_i = 200mA$ $P_i = 0.84W$ $U_o = 1.47V$ $I_o = 1.0\mu A$ $P_o = 2.2\mu W$ </p> <p> $C_i = 24nF$ $L_i = 0.01mH$ </p>																						
<p>Reset terminals RS1 & RS2 BA354E & BA358E rate totaliser only.</p> <p> $U_i = 30V$ $I_i = 200mA$ $P_i = 0.84W$ $U_o = 6V$ $I_o = 2.5mA$ $P_o = 3.8mW$ </p> <p> $C_i = 13nF$ $L_i = 0.01mH$ $C_o = 53nF$ $L_o = 0.79mH$ </p>																							
Title				Drawn		Checked		Scale															
FM & cFM Intrinsically Safe Control Drawing for BA304E, BA307E & 308E 4 DIGIT INDICATORS BA324E, 327E & BA328E 5 DIGIT INDICATORS BA354E & BA358E RATE TOTALISERS				RC				-															
				Drawing No.		CI300-72																	
				Sheet 6																			

<p style="text-align: center;">BEKA associates England Hitчин company confidential, copyright reserved.</p>		Iss.	3	Date	03.10 2012	Modification	Class II & III added to BA307E BA327E, BA308E, BA328E & BA358E	Ckd.		Appd.	
		Iss.	2	Date	11.04 2012	Modification		New drawing ATEX parameters added. See sheet 5	Ckd.		Appd.
		HAZARDOUS LOCATION		See note 3							
		NON-HAZARDOUS LOCATION		See note 1							
		Locations									
		BA304E, BA324E and BA354E									
		Class I, Division 2, Groups A, B, C & D									
		Class II, Division 2, Groups E, F & G									
		Class III									
		or Class I, Zone 2, Groups IIC									
		BA307E, BA327E, BA308E, BA328E and BA358E									
		Class I, Division 2, Groups A, B, C & D									
		Class II, Division 2, Groups E, F & G									
		Class III									
		or Class I, Zone 2, Groups IIC									
		Reset		RS1		7					
		Optional Alarm		RS2		See note 7					
		Optional Alarm		8		Hazardous Location Equipment See note 4		Non Hazardous Location Equipment			
		Optional Alarm		9		See note 3					
		Optional Alarm		10		Hazardous Location Equipment See note 4		Non Hazardous Location Equipment			
		Optional Alarm		11		See note 3					
		Optional separately powered Backlight		12		See note 3		Non Hazardous Location Equipment			
		Optional separately powered Backlight		14		See note 3					
		See notes 11 & 12		1		See note 3		Non Hazardous Location Equipment			
		See notes 11 & 12		2		See note 3					
		See notes 11 & 12		3		See note 3					
		See notes 11 & 12		4		See note 2					
		Reset		RS1		7					
		Optional Alarm		RS2		See note 7					
		Optional Alarm		8		Hazardous Location Equipment See note 4		Non Hazardous Location Equipment			
		Optional Alarm		9		See note 3					
		Optional Alarm		10		Hazardous Location Equipment See note 4		Non Hazardous Location Equipment			
		Optional Alarm		11		See note 3					
		Optional separately powered Backlight		12		See note 3		Non Hazardous Location Equipment			
		Optional separately powered Backlight		14		See note 3					
		See notes 11 & 12		1		See note 3		Non Hazardous Location Equipment			
		See notes 11 & 12		2		See note 3					
		See notes 11 & 12		3		See note 3					
		See notes 11 & 12		4		See note 2					
		Hazardous Location Equipment See note 4									
		Reset		RS1		7					
		Optional Alarm		RS2		See note 7					
		Optional Alarm		8		Hazardous Location Equipment See note 4		Non Hazardous Location Equipment			
		Optional Alarm		9		See note 3					
		Optional Alarm		10		Hazardous Location Equipment See note 4		Non Hazardous Location Equipment			
		Optional Alarm		11		See note 3					
		Optional separately powered Backlight		12		See note 3		Non Hazardous Location Equipment			
		Optional separately powered Backlight		14		See note 3					
		See notes 11 & 12		1		See note 3		Non Hazardous Location Equipment			
		See notes 11 & 12		2		See note 3					
		See notes 11 & 12		3		See note 3					
		See notes 11 & 12		4		See note 2					

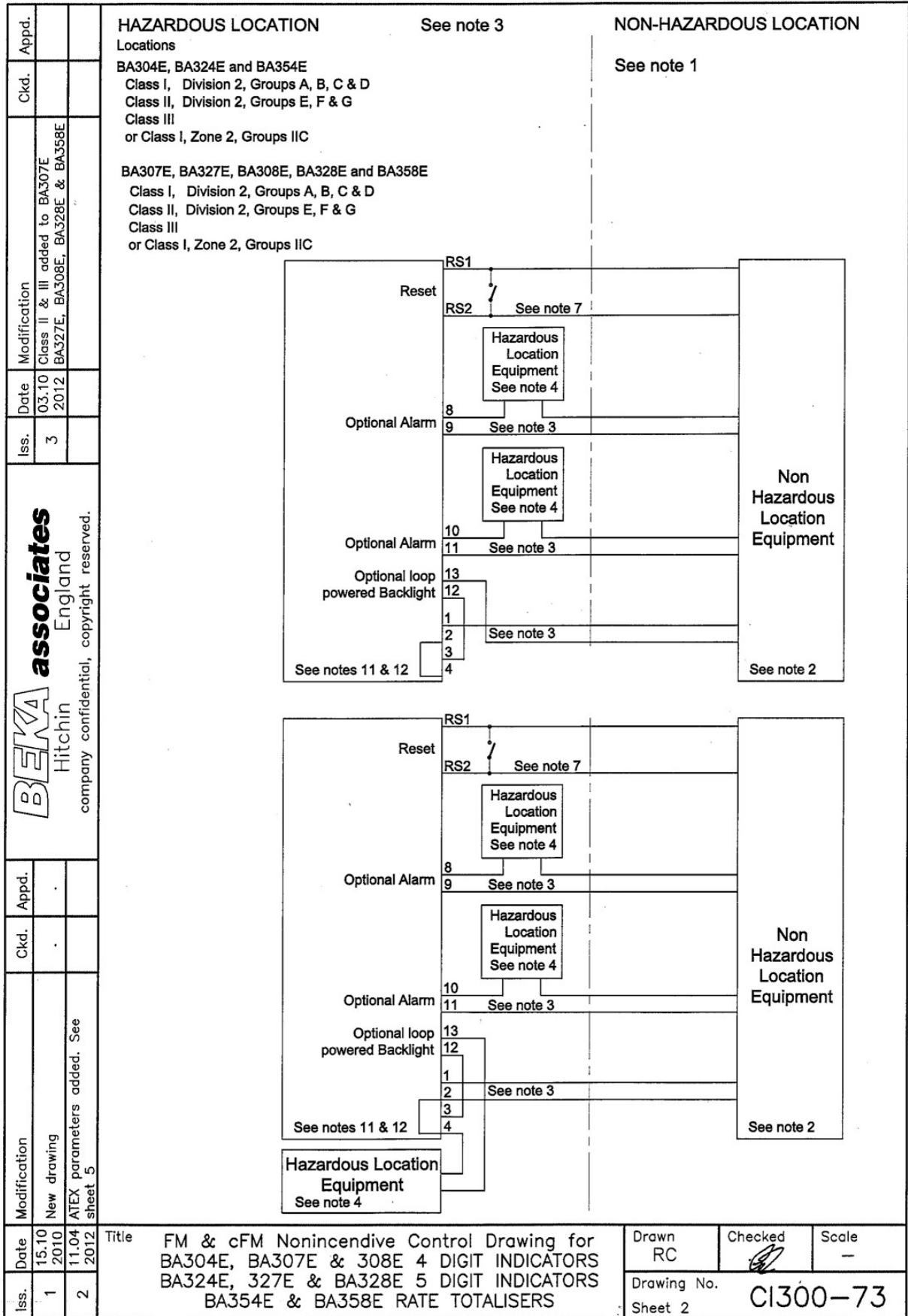

BEKA associates
Hitchin England
company confidential, copyright reserved.

Appd.
Ckd.

Modification
15.10 2010 New drawing
11.04 2012 ATEX parameters added. See sheet 5

Date
15.10 2010
11.04 2012

Title
FM & cFM Nonincendive Control Drawing for
BA304E, BA307E & 308E 4 DIGIT INDICATORS
BA324E, 327E & BA328E 5 DIGIT INDICATORS
BA354E & BA358E RATE TOTALISERS

Drawn RC	Checked 	Scale -
Drawing No. Sheet 2		CI300-73

Iss.		Date		Modification		Ckd.		Appd.	
1		15.10 2010		New drawing					
2		11.04 2012		ATEX parameters added. See sheet 5					
3		03.10 2012		No change to this sheet. See sheets 1 and 2.					

BEKA associates
Hitchin
England
company confidential, copyright reserved.



Notes

- The unclassified location equipment shall not use or generate more than 250V rms or 250V dc.
- Nonincendive field wiring installations shall be in accordance with the National Electrical Code ANSI/NFPA 70. The Nonincendive Field Wiring concept allows interconnection of Nonincendive Field Wiring Apparatus with Associated Nonincendive Field Wiring Apparatus using any of the wiring methods permitted for unclassified locations. Installations in Canada shall be in accordance with the Canadian Electrical Code C22.2.
- Classified location equipment shall be FM Approved Nonincendive Field Wiring Apparatus or simple apparatus as defined in ANSI/NFPA70. For Canadian installations classified location equipment shall be cFM or CSA Approved Nonincendive Field Wiring Apparatus.
- Simple Apparatus as defined in the National Electrical Code ANSI/NFPA 70, or for installations in Canada by the Canadian Electrical Code C22.2 or as defined in note 3.
- When installed in a hazardous (classified) location the BA304E and BA324E field mounting Indicators and the BA354 field mounting Rate Totaliser shall be fitted with cable glands / conduit hubs selected from the following table .

Metallic glands and hubs must be grounded.

Class	Permitted gland or conduit hub
Class I	Any metallic or plastic cable gland or conduit hub that provides the required environmental protection.
Class II and III	<p>Crouse – Hinds Myler hubs ST-1 STA-1 SSTG-1 STG-1 STAG-1 MHUB-1 HUB 1</p> <p>O-Z / Gedrey Hubs CHM-50DT CHMG-50DT</p> <p>REMKE hub WH-1-G</p> <p>Killark Glands CMCXAA050 MCR050 MCX050</p>

Iss.		Date		Title		Drawn	Checked	Scale
1		15.10 2010		FM & cFM Nonincendive Control Drawing for BA304E, BA307E & 308E 4 DIGIT INDICATORS BA324E, 327E & BA328E 5 DIGIT INDICATORS BA354E & BA358E RATE TOTALISERS		RC		-
2		11.04 2012				Drawing No.	CI300-73	
						Sheet 3		

Iss.	3	Date	03.10 2012	Modification	No change to this sheet. See sheets 1 and 2.	Ckd.		Appd.			
 <p>BEKA associates Hitchin England company confidential, copyright reserved.</p>											
Iss.	1	Date	15.10 2010	Modification	New drawing	Ckd.		Appd.			
Iss.	2	Date	11.04 2012	Modification	ATEX parameters added. See sheet 5	Ckd.		Appd.			
<p>6. When mounting the BA307E, BA308E, BA327E and the BA328E panel mounting Indicators and the BA358C panel mounting Rate Totaliser in an enclosure to maintain Type 4 front panel rating:</p> <p>Minimum panel thickness should be 2mm (0.08inches) Steel 3mm (0.12inches) Aluminium</p> <p>Outside panel finish should be smooth, free from particles, inclusions, runs or build-ups around cut-out.</p> <p>Panel cut-out for BA307E and BA327E should be: 90.0 x 43.5mm -0.0 +0.5mm (3.54 x 1.71 inches -0.00 +0.02)</p> <p>Two panel mounting clips are required and each should be tightened to between: 20 & 22cNm (1.77 to 1.95inLb)</p> <p>Panel cut-out for BA308E, BA328E & BA358E should be: 66.2 x 136.0mm -0.0 +0.5mm (2.60 x 5.35 inches -0.00 +0.02)</p> <p>Four panel mounting clips are required and each should be tightened to between: 20 & 22cNm (1.77 to 1.95inLb)</p> <p>7. Reset terminals RS1 and RS2 are only fitted to BA354E and BA358E Rate Totalisers. They may be connected to Associated Nonincendive Field Wiring Apparatus, Nonincendive Field Wiring Apparatus or simple apparatus such as a single pole switch.</p> <p>8. In addition to the supplied bonding plate, when 2 or 3 metallic glands or conduit hubs are fitted to a BA304E or BA324E Indicator or to a BA354E Rate Totaliser, all metallic glands or conduit hubs must be connected together and grounded.</p> <p>9. CAUTION The BA304E, BA307E, BA308E, BA324E, BA327E and the BA328E Indicators and the BA354E and the BA358C Rate Totaliser enclosures are manufactured from conducting plastic per Article 250 of the National Electrical Code.</p> <p>10. The BA304E, BA307E, BA308E, BA324E, BA327E and the BA328E Indicators and the BA354E and the BA358C Rate Totaliser shall be mounted where they are shielded from direct sunlight.</p>											
<p>Title FM & cFM Nonincendive Control Drawing for BA304E, BA307E & 308E 4 DIGIT INDICATORS BA324E, 327E & BA328E 5 DIGIT INDICATORS BA354E & BA358E RATE TOTALISERS</p>						Drawn	RC	Checked		Scale	-
						Drawing No.	CI300-73				
						Sheet 4					

Iss.	Date	Modification	Ckd.	Appd.	<p>BEKA associates Hitchin England company confidential, copyright reserved.</p>	<p>11. Safety parameters</p> <p>4/20mA input terminals 1, 2, 3 & 4</p> <p> $U_i = 30V$ $I_i = 200mA$ $P_i = 0.84W$ $U_o = 1.1V$ $I_o = 3mA$ $P_o = 4.5mW$ </p> <p> $C_i = 13nF$ $L_i = 0.01mH$ </p> <p>Separately powered backlight terminals 12 & 14.</p> <p> $U_i = 30V$ $I_i = 200mA$ $P_i = 0.84W$ </p> <p> $C_i = 13nF$ $L_i = 0.01mH$ </p> <p>Reset terminals RS1 & RS2 BA354E & BA358E rate totaliser only.</p> <p> $U_i = 30V$ $I_i = 200mA$ $P_i = 0.84W$ $U_o = 6V$ $I_o = 2.5mA$ $P_o = 3.8mW$ </p> <p> $C_i = 13nF$ $L_i = 0.01mH$ $C_o = 53nF$ $L_o = 0.79mH$ </p>	<p>4/20mA input terminals 1, 2, 3, 4, 12 & 13 & loop powered backlight.</p> <p> $U_i = 30V$ $I_i = 200mA$ $P_i = 0.84W$ $U_o = 1.1V$ $I_o = 3mA$ $P_o = 4.5mW$ </p> <p> $C_i = 13nF$ $L_i = 0.01mH$ </p> <p>Alarm terminals 8, 9, 10 and 11</p> <p> $U_i = 30V$ $I_i = 200mA$ $P_i = 0.84W$ $U_o = 1.47V$ $I_o = 1.0\mu A$ $P_o = 2.2\mu W$ </p> <p> $C_i = 24nF$ $L_i = 0.01mH$ </p>	
								Iss.
3	03.10.2012	No change to this sheet. See sheets 1 and 2.						
1	15.10.2010	New drawing						
	11.04.2012	ATEX parameters added.						
<p>Title FM & cFM Nonincendive Control Drawing for BA304E, BA307E & 308E 4 DIGIT INDICATORS BA324E, 327E & BA328E 5 DIGIT INDICATORS BA354E & BA358E RATE TOTALISERS</p>						<p>Drawn RC</p>	<p>Checked </p>	<p>Scale -</p>
						<p>Drawing No. CI300-73</p> <p>Sheet 5</p>		