

WEST

Pro-EC44

2-Loop Graphical Profile Controller & Recorder



Pro-EC44 User Guide 59540-1



WEST  Partlow

This manual supplements the Concise Product manual supplied with each instrument at the time of shipment. Information in this installation, wiring and operation manual is subject to change without notice.

Copyright © October 2013, Danaher Corporation, all rights reserved. No part of this publication may be reproduced, transmitted, transcribed or stored in a retrieval system, or translated into any language in any form by any means without the written permission of Danaher/West Control Solutions.

Copies of this manual are available in electronic format on the West Control Solutions web site (www.west-cs.com) Printed versions may be purchased from West Control Solutions or its representatives.



WARNING: THE INTERNATIONAL HAZARD SYMBOL IS INSCRIBED ADJACENT TO THE REAR CONNECTION TERMINALS. IT IS IMPORTANT TO READ THIS MANUAL BEFORE INSTALLING OR COMMISSIONING THE UNIT.

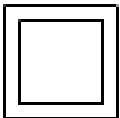

WARNING: THIS SYMBOL MEANS THE EQUIPMENT IS PROTECTED THROUGHOUT BY DOUBLE INSULATION.



WARNING: PRODUCTS COVERED BY THIS MANUAL ARE SUITABLE FOR INDOOR USE, INSTALLATION CATEGORY II, POLLUTION CATEGORY 2 ENVIRONMENTS.



Note: *It is strongly recommended that applications incorporate a high or low limit protective device, which will shut down the equipment at a pre-set process condition in order to prevent possible damage to property or products.*

This user guide covers all versions of the West Pro-EC44 controller.

Warranty and Returns Statement

These products are sold by West Control Solutions under the warranties set forth in the following paragraphs. Such warranties are extended only with respect to a purchase of these products, as new merchandise, directly from West Control Solutions or from a West Control Solutions distributor, representative or reseller and are extended only to the first buyer thereof who purchases them other than for the purpose of resale.

Warranty

These products are warranted to be free from functional defects in material and workmanship for three years from the time the products leave West Control Solutions factory and to conform at that time to the specifications set forth in the relevant West instruction manuals sheet or sheets.

THERE ARE NO EXPRESSED OR IMPLIED WARRANTIES, WHICH EXTEND BEYOND THE WARRANTIES HEREIN AND ABOVE SET FORTH. NO WARRANTY IS MADE OF MERCHANTABILITY OR FITNESS FOR A PARTICULAR PURPOSE WITH RESPECT TO THE PRODUCTS.

Limitations

West Control Solutions shall not be liable for any incidental damages, consequential damages, special damages, or any other damages, costs or expenses excepting only the cost or expense of repair or replacement as described above. Products must be installed and maintained in accordance with West Control Solutions instructions. There is no warranty against damage to the product resulting from corrosion. Users are responsible for the suitability of the products to their application.

For a valid warranty claim, the product must be returned carriage paid to the supplier within the warranty period. The product must be properly packaged to avoid damage from electrostatic discharge or other forms of harm during transit.

How to use this manual

This manual is structured to give easy access to the information required for all aspects of the installation and use and of the controller. The main sections are shown here, with a full table of contents at the end.

Warranty and Returns Statement	ii
1 Introduction.....	1
2 Installation	2
3 Field Upgrade Options	4
4 Electrical Installation.....	9
5 Powering Up.....	29
6 Messages & Error Indications.....	31
7 Application Setup	33
8 Operation and Configuration Menus	36
9 Input Calibration & Multi-point Scaling	70
10 Digital Inputs.....	75
11 Cascade Control	78
12 Ratio Control.....	81
13 Redundant Input	83
14 Valve Motor Drive / 3-Point Stepping Control.....	84
15 Setpoint Sources	86
16 Profiler.....	87
17 USB Interface	96
18 Data Recorder	97
19 Controller Tuning.....	99
20 Serial Communications	109
21 Glossary	204
22 PC Software	235
23 Specifications	245
24 Pro-EC44 Product Coding.....	255
25 Table of Contents	257

1 Introduction

This product is a $\frac{1}{4}$ DIN size (96 x 96mm front) microprocessor based graphical process controller, featuring a 160 x 80 pixel, monochrome LCD with dual colour (red/green) backlight. It operates from 100-240V at 50/60 Hz or 24V-48V AC/DC, depending on the model purchased. It can measure and control up to two process variables from a variety of sources such as temperature, pressure, flow and level. Primary and secondary control outputs are possible for each loop.

Optional features include a second process input, USB interface, remote setpoint inputs RS485 or Ethernet communications, profile control and data recording. Control options include cascade, ratio and 3-point stepping valve control. Automatic tuning or 5 stage gain-scheduling are also available.

The USB Interface option allows uploading or downloading instrument configuration settings to/from a USB memory stick, for easy configuration of multiple instruments or transfer to/from the PC configuration software. If the data recorder or profiler options are fitted, recordings and profile information can be transferred via the memory stick.

The data recorder option allows the user to make recordings of the processes over time. Recordings can be transferred to a memory stick using the USB interface or downloaded via one of the communications options.

The Profiler option allows the user to predefine up to 255 segments, shared amongst up to 64 Setpoint Profiles. These control the setpoint levels for the control loop(s) over time, increasing, decreasing or holding their values as required. When combined with the real-time clock (part of the Data Recorder option) the profiling capabilities are expanded to allow automatic program start at a defined time and day.

Inputs are user configurable for thermocouple and RTD probes, as well as linear process signal types such as mVDC, VDC or mADC. Two-point calibration or multipoint scaling can compensate for errors or non-linear signals. Output options include single or dual relays, single or dual SSR drivers, triacs or linear mA/V DC. These can be used for process control, alarms/events or retransmission of the process variable or setpoint to external devices. Transmitter power supply options can provide an unregulated 24V DC (22mA) auxiliary output voltage, or a 0 to 10VDC stabilised excitation for external signal transmitters.

Up to 7 alarms can be defined as process high or low, deviation (active above or below controller setpoint), band (active both above and below setpoint), rate of input change, control loop, PID power or signal break types. Alarm status can be indicated by lighting an LED, changing the display backlight colour or viewing the active alarm status screen. These alarms can be linked to any suitable output.

Configuration for basic applications is possible using the easy Setup Wizard run automatically at first power-up or manually later. Access to the full range of parameters is via a simple menu driven front panel interface, or the PC based configuration software.

2 Installation

Unpacking

1. Remove the product from its packing. Retain the packing for future use, in case it is necessary to transport the instrument to a different site or to return it to the supplier for servicing.
2. The instrument is supplied with a panel gasket and push-fit mounting clamp. A multi-page concise manual is supplied with the instrument, in one or more languages. Examine the delivered items for damage or defects. If any are found, contact your supplier immediately.

Installation



CAUTION: Installation should be only performed by technically competent personnel. It is the responsibility of the installing engineer to ensure that the configuration is safe. Local Regulations regarding electrical installation & safety must be observed (e.g. US National Electrical Code (NEC) or Canadian Electrical Code).

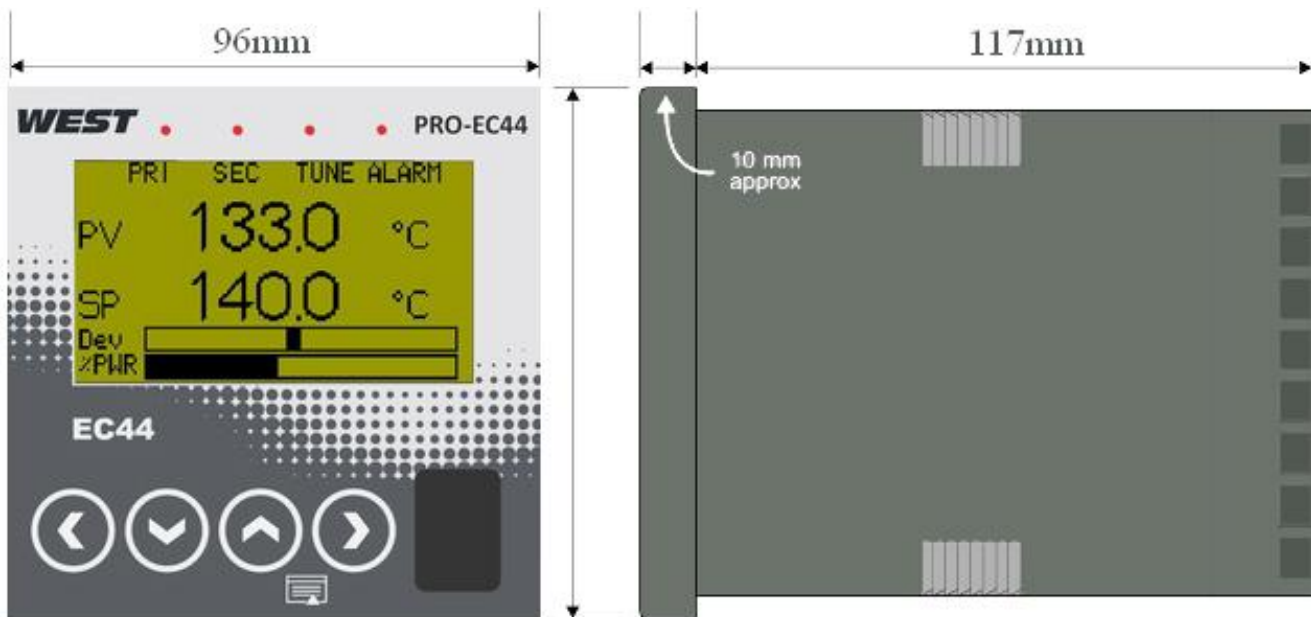

Figure 1. Main dimensions

Panel-Mounting

The controller should be mounted in a properly earthed metal cabinet. The mounting panel must be rigid and may be up to 6.0mm (0.25 inches) thick. The cut-out size is:

92mm x 92mm (+0.5mm / -0.0mm).

Instruments may be mounted side-by-side in a multiple installation, but instrument to panel moisture and dust sealing will be compromised. Allow a 20mm gap above, below and behind the instrument for ventilation. The cut-out width (for n instruments) is:

$(96n - 4)$ mm or $(3.78n - 0.16)$ inches

If panel sealing must be maintained, mount each instrument into an individual cut-out with 10mm or more clearance between the edges of the holes.



Note: *The mounting clamp tongues may engage the ratchets either on the sides or the top/bottom faces of the Instrument housing. When installing several Instruments side-by-side in one cut-out, use the ratchets on the top/bottom faces.*



CAUTION: Ensure the inside of the panel remains within the instrument operating temperature and that there is adequate airflow to prevent overheating.

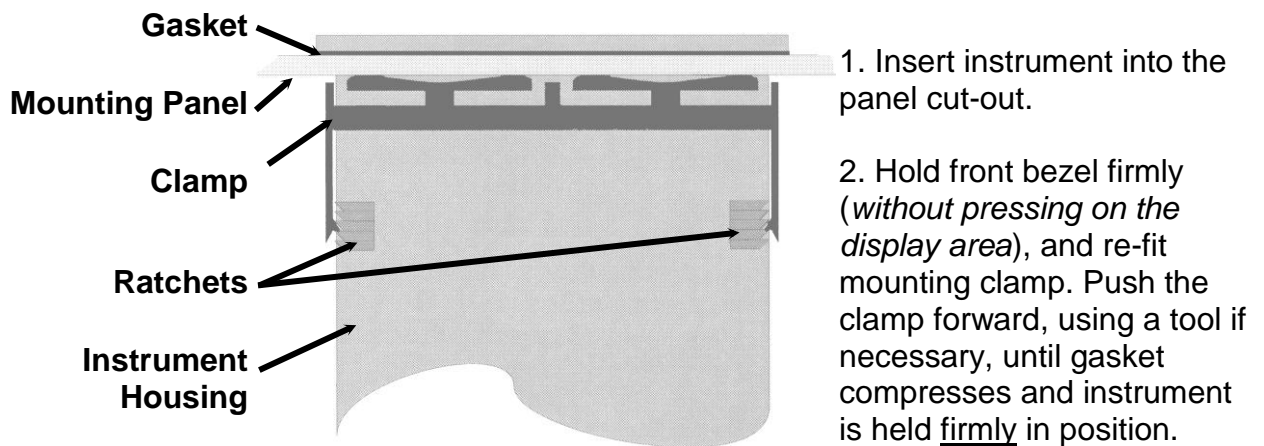

Note: *For an effective IP66 seal against dust and moisture, ensure gasket is well compressed against the panel, with the 4 tongues located in the same ratchet slot.*

Figure 2. Panel-Mounting the instrument



CAUTION: Do not remove the panel gasket, as this may result in inadequate clamping and sealing of the instrument to the panel.

Once the instrument is installed in its mounting panel, it may be subsequently removed from its housing if necessary, as described in the Fitting and Removing Plug-in Modules section.

Cleaning

Clean the front panel by washing with warm soapy water and dry immediately. If the USB option is fitted, close the USB port cover before cleaning.

3 Field Upgrade Options

Plug-Modules and Upgradeable Functions

Plug-Modules can be either pre-installed at the time of manufacture, or retrofitted in the field to expand the capabilities of the controller. Contact your supplier to purchase these items. Part numbers and circuit board identification numbers for the plug-in modules and accessories are shown in below:

PART NUMBER	AVAILABLE OPTIONS & ACCESSORIES	BOARD IDENTIFICATION NUMBER
MODULE SLOT 1		
PO1-R10	Single Relay Output for plug-in module slot 1	716/01
PO1-S20	Single SSR Driver Output for plug-in module slot 1	716/02
PO1-T80	Triac Output for plug-in module slot 1	716/03
PO1-C21	Linear mA / Voltage Output for plug-in module slot 1	639/01
MODULE SLOT 2 or 3		
PO2-R10	Single Relay Output for plug-in module slot 2 or 3	717/01
PO2-W09	Dual Relay Output for plug-in module slot 2 or 3	644/01
PO2-S20	Single SSR Driver Output for plug-in module slot 2 or 3	717/02
PO2-S22	Dual SSR Driver Output for plug-in module slot 2 or 3	644/02
PO2-T80	Triac module Output for plug-in module slot 2 or 3	647/01
PO2-W08	24VDC Transmitter Power Supply for module slot 2 or 3	642/01
MODULE SLOT A		
PA1-W03	Digital Input for plug-in module slot A	641/02
PA1-W04	Basic Auxiliary Input for plug-in module slot A	653/01
PA1-W06	RS485 Serial Communications for plug-in module slot A	680/01
PA1-ETH	Ethernet Communications for plug-in module slot A	707/01
ACCESSORIES		
PS1-PRF	Profiler Enable Key-code	
PS1-PRW	Blue Control PC Configuration Software & Lead	



CAUTION: Plastic pegs prevent fitting of older non-reinforced single relay modules (board identification numbers 637/01 and 638/01). Fitting the older relay modules reduces the isolation rating to Basic 240V isolation and is therefore not recommended.

Remove this peg when fitting Dual Relay Modules.

Board Positions



Note: All dual relay modules have reinforced isolation.

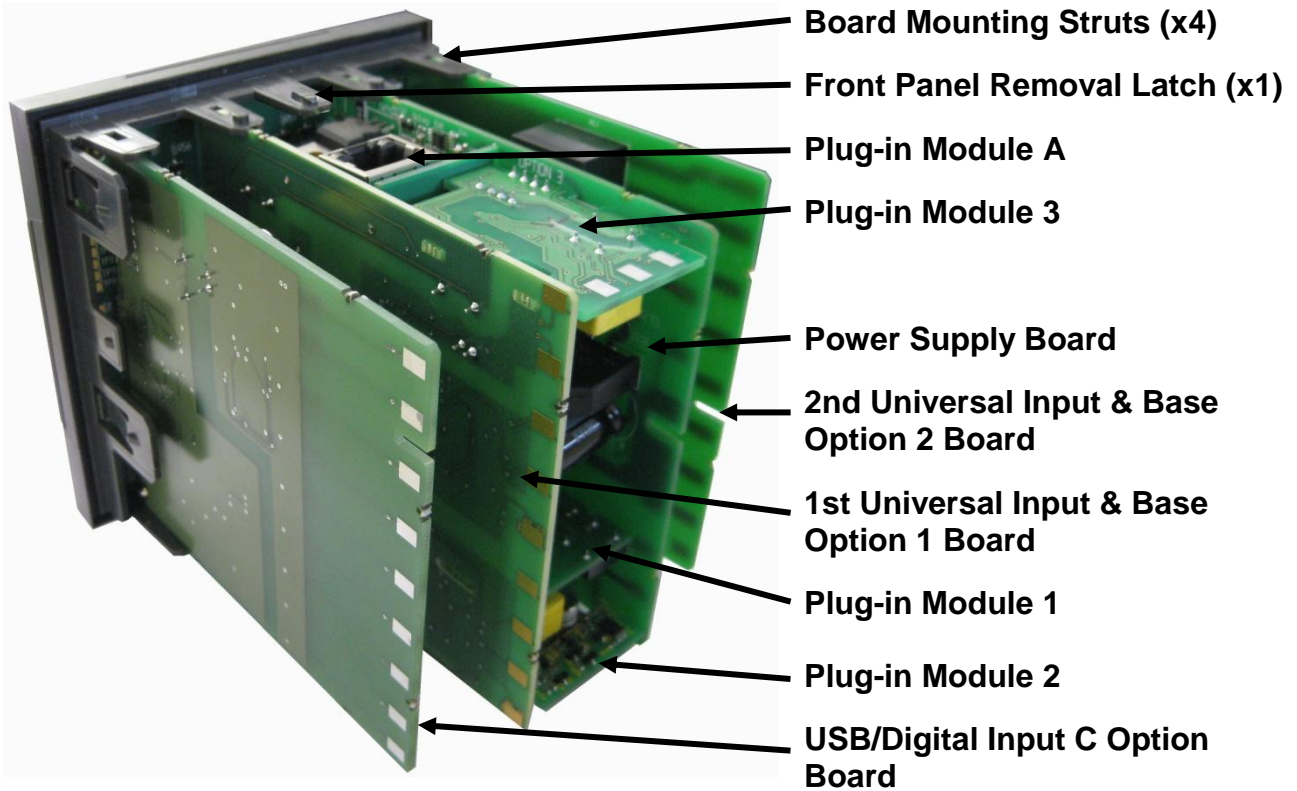

Figure 3. Rear view (uncased) & board positions

Preparing to Install or Remove Plug-in Modules



CAUTION: Before removing the instrument from its housing, ensure that all power has been removed from the rear terminals. Modules / boards should be replaced by a technically competent technician.

1. Grip the edges of the front panel (there is a finger grip on each edge) and pull it forwards approximately 10mm, until the Front Panel Removal Latch prevents further movement. The purpose of the latch is to prevent removal of the instrument without the use of a tool.
2. The Front Panel Removal Latch must be pushed down to allow removal of the instrument. Using a tool (e.g. screwdriver or pen tip), press down it down through the front central ventilation hole. This will release the instrument from the case.
3. The internal boards can now be accessed. Take note of the orientation of the instrument and boards for subsequent replacement into the housing. The positions of the boards, their mountings and the Front Panel Removal Latch are shown above.

Main Board Connectors

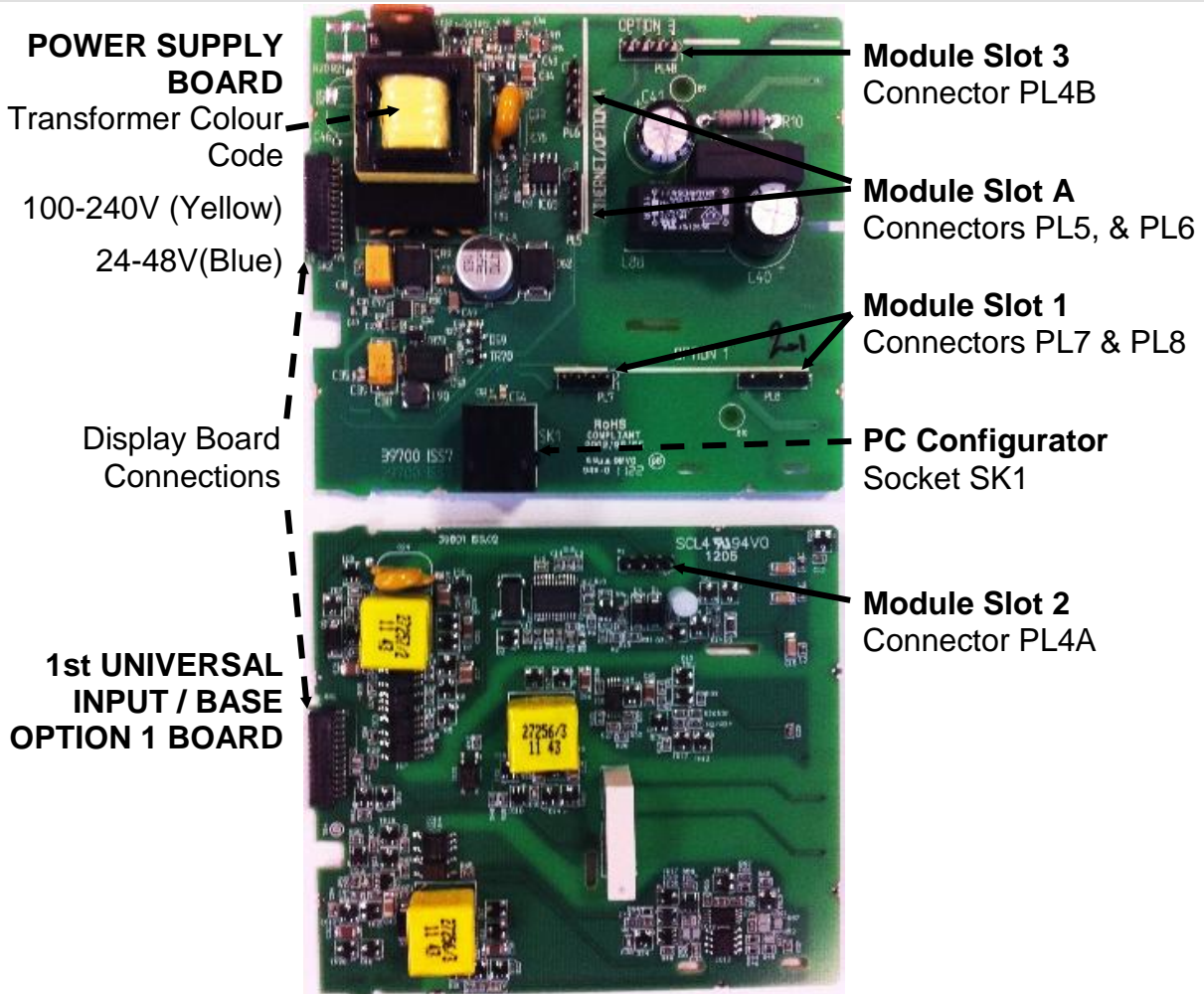

Figure 4. Main board connectors

This product is designed to allow the user to reconfigure some hardware options in the field by changing the plug-in modules in slots 1, 2, 3, & A located on the power supply and 1st universal input boards. The main boards (display/CPU, power supply, inputs 1 & 2 and digital input/USB) are factory fitted, but may be removed while reconfiguring the plug-in modules. Take care when re-fitting these boards. Observe the power supply board transformer colour, and case labelling to check the supply voltage, otherwise irreparable damage may occur.



CAUTION: Replacement of boards must be carried out by a technically competent technician. If the Power Supply board does not match the labelling, users may apply incorrect voltage resulting in irreparable damage.

Removing/Replacing Option Modules

1. To remove or replace Plug-in Modules 1, 2, 3 or A it is necessary to detach the power supply and input boards from the front panel by lifting first the upper and then lower mounting struts.
2. Remove or fit the modules to the connectors on the power supply and input boards. The location of the connectors is shown below. Plastic pegs prevent fitting of older non-reinforced single relay modules – *Remove the peg to fit dual relay modules*
3. Assemble the Power Supply and Input boards together. Tongues on each option module locate into slots cut into the main boards, opposite each of the connectors. Hold the Power and Input boards together and relocate them back on their mounting struts.
4. Push the boards forward to ensure correct connection to the front Display/CPU board and re-check the installation of the Option C and/or 2nd Input / Base Option 2 boards if present.



CAUTION: Check for correct orientation of the modules and that all pins are located correctly.

Replacing the Instrument in its Housing



CAUTION: Before replacing the instrument in its housing, ensure that all power has been removed from the rear terminals.

With the required option modules correctly located into their respective positions the instrument can be replaced into its housing as follows:

1. Hold the Power Supply and Input boards together.
2. Align the boards with the guides in the housing.
3. Slowly and firmly, push the instrument into position in its case.



CAUTION: Ensure that the instrument is correctly orientated. A mechanical stop will operate if an attempt is made to insert the instrument in the wrong orientation, this stop **MUST NOT** be over-ridden.

Auto Detection of Plug-in Modules

The instrument automatically detects which plug-in modules have been fitted into each slot. The menus and screens change to reflect the options compatible with the hardware. The modules fitted can be viewed in the product information menu, as detailed in the Product & Service Information Mode section of this manual.

Data Recorder Board

If installed, the Data Recorder memory and Real Time Clock (RTC) components are located on a plug-in daughter board attached to the front Display/CPU board.



CAUTION: Servicing of the Data Recorder/RTC circuit and replacement of the lithium battery should only be carried out by a technically competent technician.



Profiler Enabling



If you purchased a controller with the Profiler option installed, these features will be enabled during manufacture.

Controllers supplied without the Profiler option installed can be upgraded in the field by purchasing a licence code number from your supplier. A unique code must be purchased to enable profiling on each controller that requires it.

Entering the Profiler Enable Code

Hold down the  and  keys during the power-up “splash screen”.

Using the  or  keys, enter the 16-character licence code in the displayed screen.

Press  to move on to the next character. Press  to move back to the previous character.

Press  after entering the final character.

To confirm if profiling is installed in your instrument, check the Controller Feature Information in Product & Service Information Mode.

4 Electrical Installation



CAUTION: Installation should be only performed by technically competent personnel. It is the responsibility of the installing engineer to ensure that the configuration is safe. Local Regulations regarding electrical installation & safety must be observed (e.g. US National Electrical Code (NEC) or Canadian Electrical Code).

Avoiding EMC Problems

This controller has passed EMC compliance tests to EN61326. There should be no difficulty achieving this level of compliance in use, but it should be borne in mind that the wiring of the installation can significantly reduce the efficiency of instrumentation immunity due to the ease with which high frequency RF can enter via unprotected cables.

The following general recommendations can reduce the possibility of EMC problems.

1. If the instrument is being installed in existing equipment, wiring in the area should be checked to ensure that good wiring practices have been followed.
2. The controller should be mounted in a properly earthed metal cabinet. All round metal shielding is important, so the cabinet door may require a conductive sealing strip.
3. It is good practice to ensure that the AC neutral is at or near ground (earth) potential. A proper neutral will help ensure maximum performance from the instrument.
4. Consider using a separate isolation transformer to feed only the instrumentation. A transformer can protect instruments from noise found on the AC power supply.

Cable Isolation & Protection

Four voltage levels of input and output wiring may be used with the unit:

1. Analogue inputs or outputs (for example thermocouple, RTD, VDC, mVDC or mADC)
2. Relays & Triac outputs
3. Digital Inputs & SSR Driver outputs
4. AC power



CAUTION: The only wires that should run together are those of the same category.

If any wires need to run parallel with any from another category, maintain a minimum space of 150mm between them. If wires MUST cross each other, ensure they do so at 90 degrees to minimise interference.

Keep signal cables as short as possible. If an earthed thermocouple is used or if the sensor has a screened cable, it should be earthed at one point only, preferably at the sensor location or cabinet entry point, by means of a metal gland. Ideally all analogue and digital signals should be shielded like this, but for unscreened cables, large diameter ferrite sleeves at the cabinet entry point are an effective method of reducing RF interference. Looping cables through the ferrite sleeves a number of times improves the efficiency of the filtering. For mains input cables the fitting a suitable mains filter can provide good results.

Noise Suppression at Source

If possible, eliminate mechanical contact relays and replace with solid-state relays. Noise-generating devices such as Ignition transformers, arc welders, motor drives, relays and solenoids should be mounted in a separate enclosure. If this is not possible, separate them from the instrumentation, by the largest distance possible.

Many manufacturers of relays, contactors etc supply 'surge suppressors' to reduce noise at its source. For those devices that do not have surge suppressors supplied, Resistance-Capacitance (RC) networks and/or Metal Oxide Varistors (MOV) may be added.

Inductive coils:- MOVs are recommended for transient suppression in inductive coils. Connect as close as possible, in parallel to the coil. Additional protection may be provided by

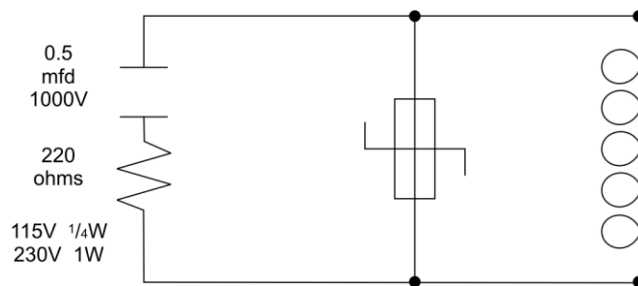

adding an RC network across the MOV.

Figure 5. Transient suppression with inductive coils

Contacts:- Arcing may occur across contacts when they open and close. This results in electrical noise as well as damage to the contacts. Connecting a properly sized RC network can eliminate this arc.

For circuits up to 3 amps, a combination of a 47 ohm resistor and 0.1 microfarad capacitor (1000 volts) is recommended. For circuits from 3 to 5 amps, connect two of these in parallel.

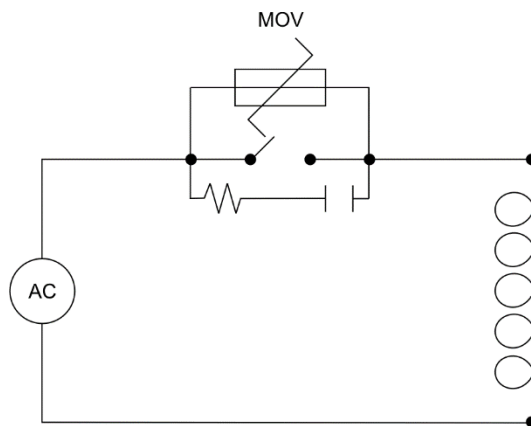

Figure 6. Contact noise suppression

Sensor Placement (Thermocouple or RTD)

If a temperature probe is to be subjected to corrosive or abrasive conditions, it must be protected by an appropriate thermowell.

Probes must be positioned to reflect the true process temperature:

1. In a liquid media - the most agitated area
2. In air - the best circulated area



CAUTION: The placement of probes into pipe work some distance from the heating vessel leads to transport delay, which results in poor control.

For a two wire RTD, a wire link should be used in place of the third wire (see the wiring section for details). Two wire RTDs should only be used with lead lengths less than 3 metres. Use of three wire RTDs is strongly recommended to reduce errors do to lead resistance.

Thermocouple Wire Identification

The different thermocouple types are identified by their wires colour, and where possible, the outer insulation as well. There are several standards in use throughout the world, but most regions now use the International IEC584-3 standard.

The table below shows the wire and sheath colours used for most common thermocouple types. The format used in this table is:

+ Wire	Sheath
- Wire	

THERMOCOUPLE WIRE COLOUR CHART											
Type		International IEC584-3		USA ANSI MC 96.1		British BS1843		French NFC 42-324		German DIN 43710	
J	+*	Black	Black	White	Black	Yellow	Black	Yellow	Black	Red	Blue
	-	White	Black	Red	Black	Blue	Black	Black	Black	Blue	Blue
T	+	Brown	Brown	Blue	Blue	White	Blue	Yellow	Blue	Red	Brown
	-	White	Brown	Red	Blue	Blue	Blue	Blue	Blue	Brown	Brown
K	+	Green	Green	Yellow	Yellow	Brown	Red	Yellow	Yellow	Red	Green
	-*	White	Green	Red	Yellow	Blue	Red	Purple	Yellow	Green	Green
N	+	Pink	Pink	Orange	Orange	Orange	Orange				
	-	White	Pink	Red	Orange	Blue	Orange				
B	+	Grey	Grey	Grey	Grey					Red	Grey
	-	White	Grey	Red	Grey					Grey	Grey
R & S	+	Orange	Orange	Black	Green	White	Green	Yellow	Green	Red	White
	-	White	Orange	Red	Green	Blue	Green	Green	Green	White	White
C (W5)	+			White	White						
	-			Red	White						



Note: * = Wire is magnetic – a magnet can be used to assist with correctly identifying the type and polarity of the conductors

Pre-wiring – Cautions, Warnings & Information



CAUTION: Installation should be only performed by technically competent personnel. It is the responsibility of the installing engineer to ensure that the configuration is safe. Local Regulations regarding electrical installation & safety must be observed (e.g. US National Electrical Code (NEC) or Canadian Electrical Code).



CAUTION: This equipment is designed for installation in an enclosure that provides adequate protection against electric shock. The isolation switch should be located in close proximity to the unit, in easy reach of the operator and appropriately marked.

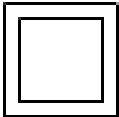

WARNING: This symbol means the equipment is protected throughout by double insulation. All external circuits connected must provide double insulation. Failure to comply with the installation instructions may impact the protection provided by the unit.

WARNING:

TO AVOID ELECTRICAL SHOCK, AC POWER WIRING MUST NOT BE CONNECTED TO THE SOURCE DISTRIBUTION PANEL UNTIL ALL WIRING PROCEDURES ARE COMPLETED. CHECK THE INFORMATION LABEL ON THE CASE TO DETERMINE THE CORRECT VOLTAGE BEFORE CONNECTING TO A LIVE SUPPLY.

Connections and Wiring

Central Terminal Connections



Note: The wiring diagram below shows all possible combinations to the main connections (numbered 1 to 24) in the centre of the case rear. The actual connections required depends upon the features and modules fitted.

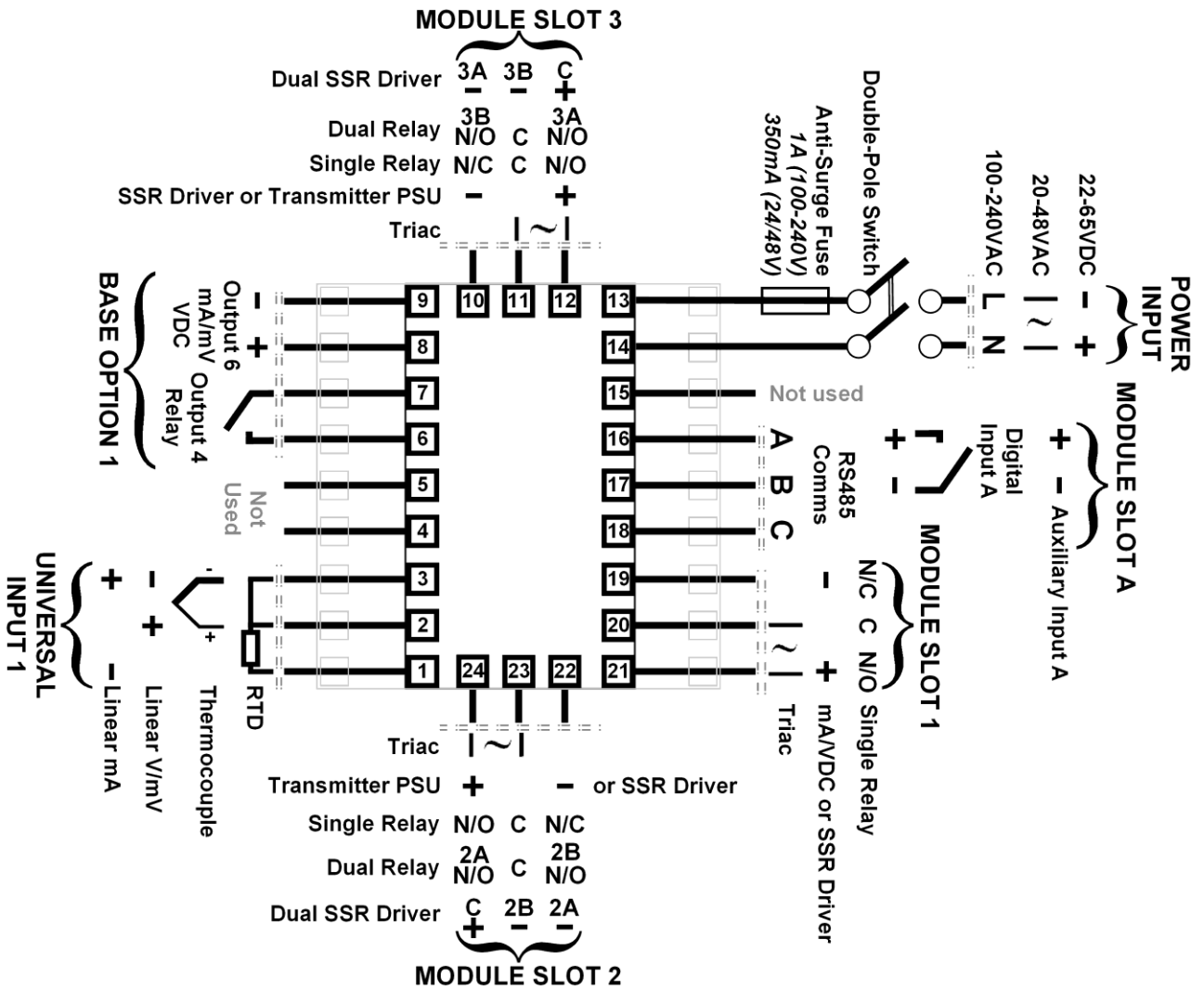

Figure 7. Central Terminals 1 to 24

WARNING:

CHECK THE INFORMATION LABEL ON THE CASE TO DETERMINE THE CORRECT VOLTAGE BEFORE CONNECTING TO A LIVE SUPPLY.

Outer Terminal Connections



Note: The wiring diagram below shows the Central Terminals (numbered 25 to 42) at the sides of the case rear. Connections for the 2nd Input, Base Option 2 and Digital Input C are shown. The actual connections required depends upon the features and modules fitted.

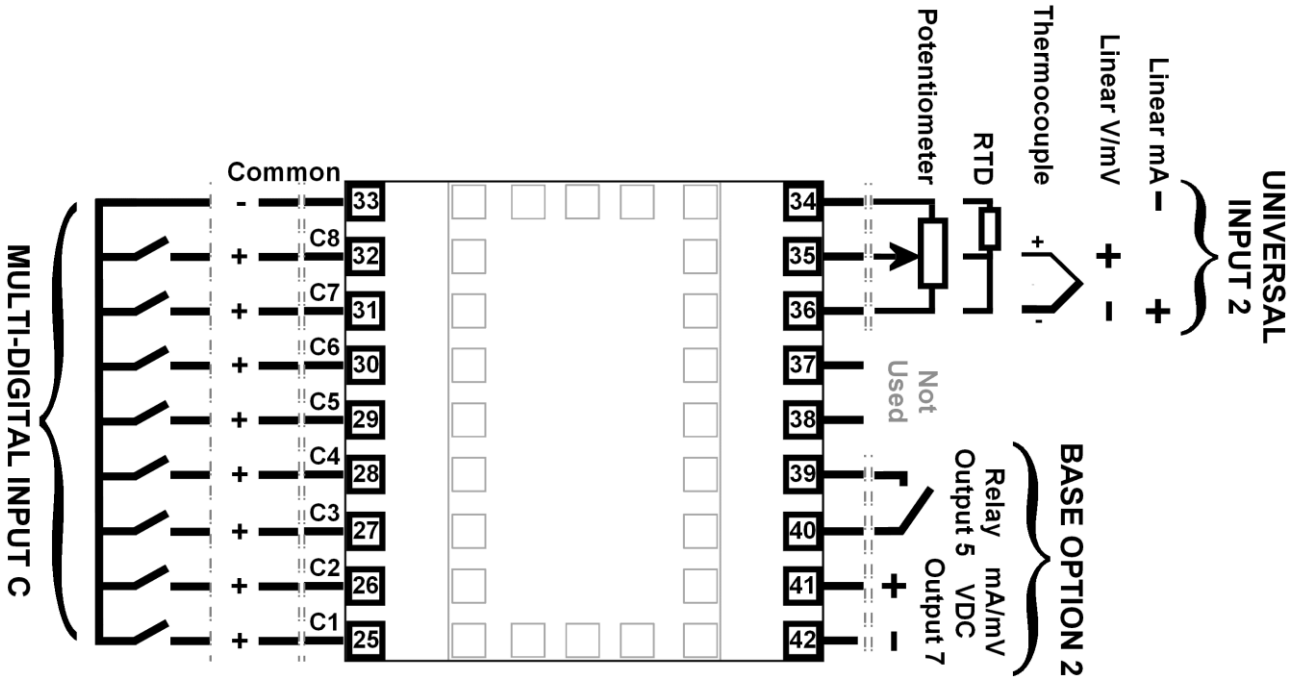

Figure 8. Outer Terminals 25 to 42

Power Connections

WARNING:

CHECK THE INFORMATION LABEL ON THE CASE TO DETERMINE THE CORRECT VOLTAGE BEFORE CONNECTING TO A LIVE SUPPLY.



CAUTION: This equipment is designed for installation in an enclosure that provides adequate protection against electric shock. An isolation switch should be located in close proximity to the unit, in easy reach of the operator and appropriately marked.

Power Connections - Mains Powered Instruments

Mains powered instruments operate from a 100 to 240V ($\pm 10\%$) 50/60Hz supply. Power consumption is 20VA. Connect the line and neutral as illustrated via a UL listed fuse type: 250V AC 1Amp anti-surge and a two-pole IEC60947-1 & IEC60947-3 compliant isolation switch / circuit breaker located within easy reach of the operator and appropriately marked. If relays switch mains voltage this should be separate from the instruments mains supply.

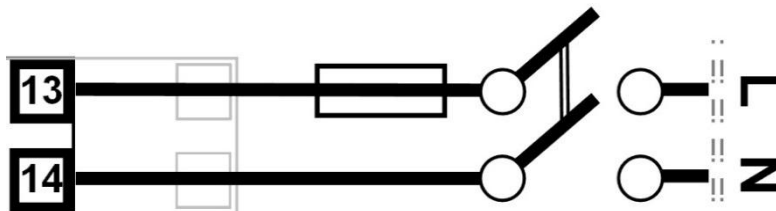

Figure 9. Mains Power Connections

Power Connections - 24/48V AC/DC Powered Instruments

24/48V AD/DC powered instruments will operate from a 20 to 48V AC or 22 to 55V DC supply. AC power consumption is 15VA max, DC power consumption is 12 watts max. Connection should be via a UL listed fuse type: 65v dc 350mAmp anti-surge and a two-pole IEC60947-1 & IEC60947-3 compliant isolation switch / circuit breaker located within easy reach of the operator and appropriately marked.

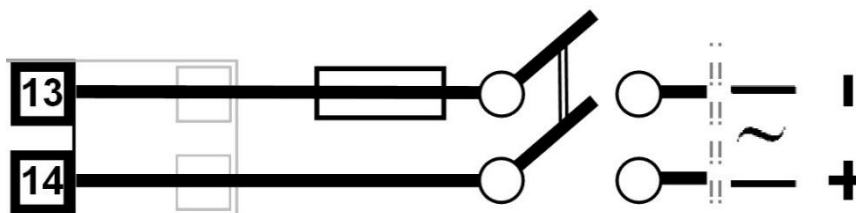

Figure 10. 24/48V AC/DC Power Connections

Universal Input 1 Connections

Universal Input 1 is present on all models. This input is normally used for the measured variable signal from a process to be controlled. It can be connected to thermocouples; resistance temperature detectors; analogue mA; mV or V DC signals. The input settings are in the Input 1 Configuration sub-menu. Connections for the various types are shown below. Ensure that the signal is correctly connected, paying particular attention to the polarity.

Universal Input 1 Connections - Thermocouple (T/C)

Supported thermocouple types & ranges are listed in the input specifications section on page 245. Only use the correct thermocouple wire or compensating cable from the sensor to the instrument terminals avoiding joints in the cable if possible. Where joints are made, special thermocouple connectors must be used. Failure to use the correct wire type and connectors will lead to inaccurate readings. Ensure correct polarity of the wires by cross-referencing the colours with the thermocouple reference table above.

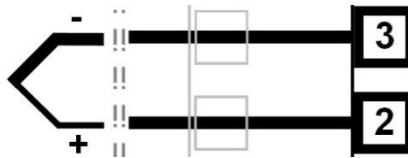

Figure 11. Input 1 - Thermocouple Connections

Universal Input 1 Connections – PT100 / NI120 (RTD) input

The inputs supports two types of RTD. PT100 (platinum sensor, 100 Ω at 0°C). For three wire RTDs, connect the resistive leg and the common legs of the RTD as illustrated. For a two wire RTD a wire link should be fitted across terminals 2 & 3 (in place of the third wire). Two wire RTDs should only be used when the leads are less than 3 metres long. Avoid cable joints.

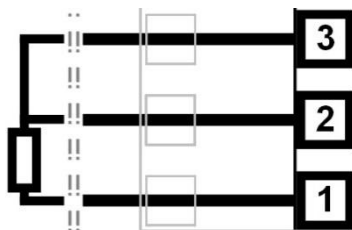

Figure 12. Input 1 - RTD Connections

Four wire RTDs can be used, provided that the fourth wire is left unconnected. This wire should be cut short or tied back so that it cannot contact any of the terminals on the rear of the instrument.

Universal Input 1 Connections - Linear Volt, mV or mA input

The input supports the following linear/analogue signals: 0 to 50mV; 10 to 50mV; 0 to 5V; 1 to 5V; 0 to 10V; 2 to 10V; 0 to 20mV; 4 to 20mA from any suitable source. Voltage & millivolt signals are connected to terminals 2 & 3, milliamp signals are connected to 1 & 3. Carefully observe the position & polarity of the connections.

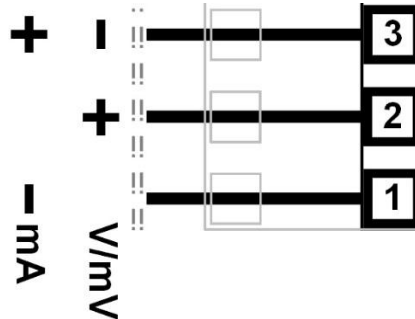

Figure 13. Input 1 - DC Volt, mV & mA Connections

Universal / Auxiliary Input 2 Connections

An Auxiliary Input 2 option is fitted to some models. This can connect to a potentiometer; analogue mA; mV or V DC signal for a remote setpoint input signal, or for flow/valve position feedback information.

Alternatively, a second Universal Input 2 option may be fitted. In addition to the remote setpoint input signal or feedback information possible with the auxiliary input, the 2nd Universal Input can be used as a second process control loop for two control loops, or used in conjunction with input one in more complex single control loops. Universal Input 2 can be connected to thermocouples; resistance temperature detectors; potentiometers; analogue mA; mV or V DC signals.

The settings are in the Input 2 Configuration sub-menu. Connections for the various types are shown below. Ensure that the signal is correctly connected, paying particular attention to the polarity.

Universal Input 2 Connections - Thermocouple (T/C)

The optional 2nd universal input, supports various thermocouple types. Supported types & ranges are listed in the input specifications section on page 245.

Only use the correct thermocouple wire or compensating cable from the sensor to the instrument terminals avoiding joints in the cable if possible. Where joints are made, special thermocouple connectors must be used. Failure to use the correct wire type and connectors will lead to inaccurate readings. Ensure correct polarity of the wires by cross-referencing the colours with a thermocouple reference table.

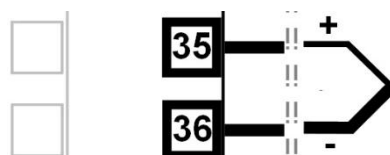

Figure 14. Input 2 - Thermocouple Connections

Universal Input 2 Connections – PT100 / NI120 (RTD) input

The optional 2nd universal input, supports two types of RTD. PT100 (platinum sensor, 100Ω at 0°C). For three wire RTDs, connect the resistive leg and the common legs of the RTD as illustrated. For a two wire RTD a wire link should be fitted across terminals 35 & 36 (in place of the third wire). Two wire RTDs should only be used when the leads are less than 3 metres long. If possible, avoid cable joints.

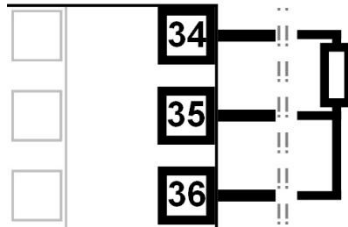

Figure 15. Input 2 - RTD Connections

Four wire RTDs can be used, provided that the fourth wire is left unconnected. This wire should be cut short or tied back so that it cannot contact any of the terminals on the rear of the instrument.

Universal / Auxiliary Input 2 Connections - Linear Volt, mV or mA input

The optional auxiliary or 2nd universal input supports the following linear/analogue signals: 0 to 50mV; 10 to 50mV; 0 to 5V; 1 to 5V; 0 to 10V; 2 to 10V; 0 to 20mV; 4 to 20mA from any suitable source. Voltage & millivolt signals are connected to terminals 2 & 3, milliamp signals are connected to 1 & 3. Carefully observe the polarity of the connections.

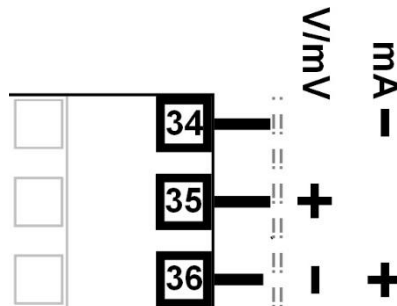

Figure 16. Input 2 - DC Volt, mV & mA Connections

Universal / Auxiliary Input 2 Connections – Potentiometer

The optional auxiliary or 2nd universal input, the terminals detailed below can be used to connect a feedback potentiometer. Minimum potentiometer resistance is ≥100Ω.

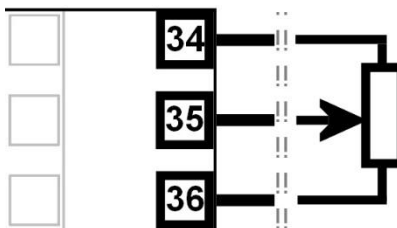

Figure 17. Input 2 - Potentiometer Connections

Base Option 1

Base Option 1 provides one or two factory fitted outputs. A relay designated as Output 4 is fitted on all models, and an optional linear mA/V DC designated as Output 6. Base options cannot be added after manufacture. The functions of outputs 4 & 6 are set in the Output Configuration sub-menu. Connect as illustrated below.

Base Option 1 Relay Output 4

Present on all instruments, Output 4 is a SPST relay, rated at 2 amps at 240 VAC resistive. If it is used to switch mains voltages, the supply should be separate from the instrument supply and should be correctly switched and fused.

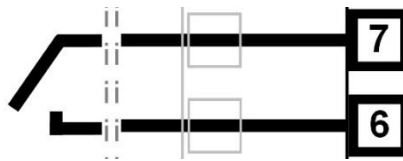

Figure 18. Relay Output 4 Connections

Base Option 1 Linear Output 6

Part of base option 1, Output 6 is an optional linear mV/V DC analogue output. The type & range are selectable from 0 to 5, 0 to 10, 2 to 10V & 0 to 20 or 4 to 20mA.

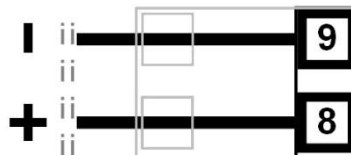

Figure 19. Linear Output 6 Connections

Base Option 2

Base Option 2 provides one or two factory fitted outputs. An optional relay designated as Output 5, and an optional linear mA/V DC designated as Output 7. Base options cannot be added after manufacture. The functions of outputs 5 & 7 are set in the Output Configuration sub-menu. Connect as illustrated below.

Base Option 2 Relay Output 5

Part of base option 2, Output 5 is a SPST relay, rated at 2 amps at 240 VAC resistive. If it is used to switch mains voltages, the supply should be separate from the instrument supply and should be correctly switched and fused.

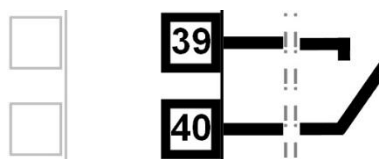

Figure 20. Relay Output 5 Connections

Base Option 2 Linear Output 7

Part of base option 2, Output 7 is an optional linear mV/V DC analogue output. The type & range are selectable from 0 to 5, 0 to 10, 2 to 10V & 0 to 20 or 4 to 20mA.

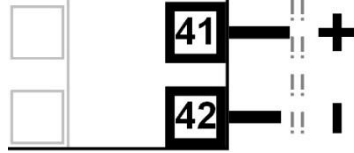

Figure 21. Linear Output 7 Connections

Plug-in Module Slot 1 Connections

A selection of plug-in modules are available for Module Slot 1. They can be fitted during manufacture, or purchased and fitted later by the user. Modules in slot 1 are designated Output 1. They are not interchangeable with those in slot 2 or 3. Their function is set in the Output Configuration sub-menu. Connect as illustrated below.

Plug-in Module Slot 1 – Single Relay Output Module

If fitted with a single relay output module, connect as shown. The relay contacts are SPDT and rated at 2 amps resistive, 240 VAC. If it is used to switch mains voltages, the supply should be separate from the instrument supply and should be correctly switched and fused.

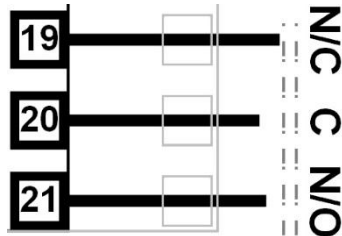

Figure 22. Plug-in Module Slot 1 – Single Relay Module

Plug-in Module Slot 1 – Single SSR Driver Output Module

If fitted with a single SSR Driver output module, connect as shown. The 10V DC pulse signal (load ≥500 ohms) is isolated from all inputs/outputs except other SSR drivers.

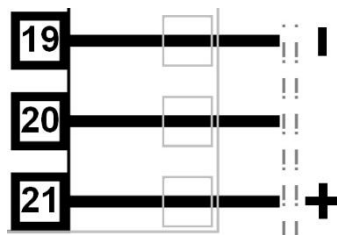

Figure 23. Plug-in Module Slot 1 – Single SSR Driver Module

Plug-in Module Slot 1 - Triac Output Module

If fitted with a triac output module, connect as shown. This output is rated at 0.01 to 1 amp @ 280V AC 50/60Hz. Isolated from all other inputs and outputs. A snubber should be fitted across inductive loads to ensure reliable switch off of the Triac.

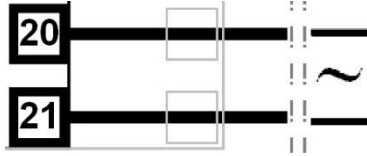

Figure 24. Plug-in Module Slot 1 - Triac Module

Plug-in Module Slot 1 - Linear Voltage or mADC Output module

If fitted with a DC linear output module, connect as shown. Output type & range are selectable from 0 to 5, 0 to 10, 2 to 10V & 0 to 20 or 4 to 20mA. Isolated from all other inputs and outputs.

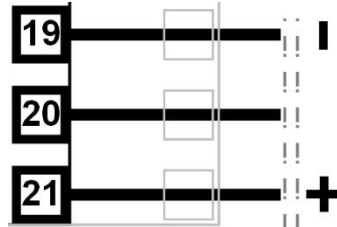

Figure 25. Plug-in Module Slot 1 - Linear Voltage & mADC Module

Plug-in module slot 2 Connections

A selection of plug-in modules are available for Module Slot 2. They are interchangeable with slot 3, but not slot 1. They can be fitted during manufacture, or purchased and fitted later by the user. Modules in slot 2 are designated Output 2, and for dual modules Output 2A and 2B. Their functions are set in the Output Configuration sub-menu. Connect as illustrated below.

Plug-in Module Slot 2 – Single Relay Output Module

If fitted with a single relay output module, connect as shown. The relay contacts are SPDT and rated at 2 amps resistive, 240 VAC. If it is used to switch mains voltages, the supply should be separate from the instrument supply and should be correctly switched and fused.

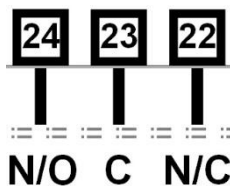

Figure 26. Plug-in Module Slot 2 – Single Relay Module

Plug-in Module Slot 2 - Dual Relay Output Module

If fitted with a dual relay output module, connect as shown. This module has two independent SPST relays for outputs 2A and 2B, with a shared common terminal. The contacts are rated at 2 amp resistive 240 VAC. If used to switch mains voltages, the supply should be separate from the instruments mains supply and the contacts should be correctly switched and fused.

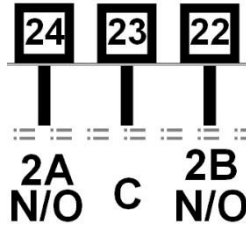

Figure 27. Plug-in Module Slot 2 - Dual Relay Module

Plug-in Module Slot 2 – Single SSR Driver Output Module

If fitted with a single SSR Driver output module, connect as shown. The 10V DC pulse signal (load ≥ 500 ohms) is isolated from all inputs/outputs except other SSR drivers.

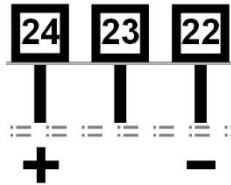

Figure 28. Plug-in Module Slot 2 – Single SSR Driver Module

Plug-in Module Slot 2 – Dual SSR Driver Output Module

If fitted with a dual SSR Driver output module, the two solid-state relay driver outputs are designated as Output 2A and 2B. The outputs are 10V DC pulse signals, (load ≥ 500 ohms). They are isolated from all inputs/output except other SSR driver outputs. Connect as shown making note of the shared positive common terminal.

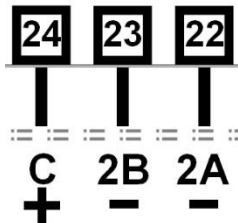

Figure 29. Plug-in Module Slot 2 – Dual SSR Driver Module

Plug-in Module Slot 2 - Triac Output Module

If fitted with a Triac output module, connect as shown. This output is rated at 0.01 to 1 amp @ 280V AC 50/60Hz. Isolated from all other inputs and outputs. A snubber should be fitted across inductive loads to ensure reliable switch off of the Triac.

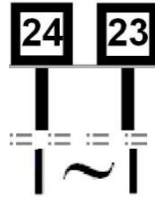

Figure 30. Plug-in Module Slot 2 - Triac Module

Plug-in Module Slot 2 - Transmitter Power Supply Module

If fitted with a transmitter power supply module (TxPSU), connect as shown. The output is a 24V nominal (unregulated, 19 to 28V DC), supply at 22mA max. Only one TxPSU is supported, do not fit in slot 2 if one is already fitted in slot 3.

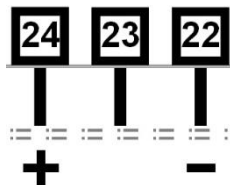

Figure 31. Plug-in Module Slot 2 - Transmitter Power Supply Module

Plug-in Slot 3 Connections

A selection of plug-in modules are available for Module Slot 3. They are interchangeable with slot 2, but not slot 1. They can be fitted during manufacture, or purchased and fitted later by the user. Modules in slot 3 are designated Output 3, and for dual modules Output 3A and 3B. Their functions are set in the Output Configuration sub-menu. Connect as illustrated below.

Plug-in Module Slot 3 – Single Relay Output Module

If fitted with a single relay output module, connect as shown. The relay contacts are SPDT and rated at 2 amps resistive, 240 VAC. If it is used to switch mains voltages, the supply should be separate from the instrument supply and should be correctly switched and fused.

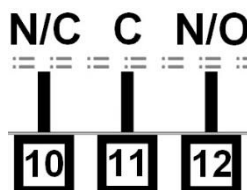

Figure 32. Plug-in Module Slot 3 – Single Relay Module

Plug-in Module Slot 3 - Dual Relay Output Module

If fitted with a dual relay output module, connect as shown. This module has two independent SPST relays for outputs 3A and 3B, with a shared common terminal. The contacts are rated at 2 amp resistive 240 VAC. If used to switch mains voltages, the supply should be separate from the instruments mains supply and the contacts should be correctly switched and fused.

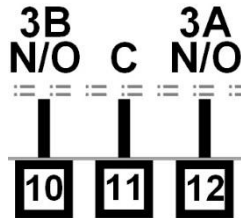

Figure 33. Plug-in Module Slot 3 - Dual Relay Module

Plug-in Module Slot 3 – Single SSR Driver Output Module

If fitted with a single SSR Driver output module, connect as shown. The 10V DC pulse signal (load ≥ 500 ohms) is isolated from all inputs/outputs except other SSR drivers.

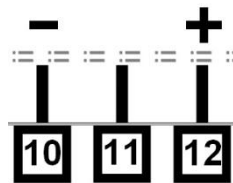
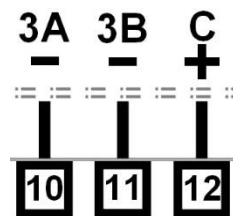

Figure 34. Plug-in Module Slot 3 – Single SSR Driver Module

Plug-in Module Slot 3 – Dual SSR Driver Output Module

If fitted with a dual SSR Driver output module, the two solid-state relay driver outputs are designated as Output 3A and 3B. The outputs are 10V DC pulse signals, (load ≥ 500 ohms). They are isolated from all inputs/output except other SSR driver outputs. Connect as shown making note of the shared positive common terminal.

Figure 35. Plug-in Module Slot 3 – Dual SSR Driver Module



Plug-in Module Slot 3 - Triac Output Module

If fitted with a Triac output module, connect as shown. This output is rated at 0.01 to 1 amp @ 280V AC 50/60Hz. Isolated from all other inputs and outputs. A snubber should be fitted across inductive loads to ensure reliable switch off of the Triac.

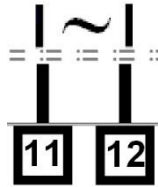

Figure 36. Plug-in Module Slot 3 - Triac Module

Plug-in Module Slot 3 - Transmitter Power Supply Module

If fitted with a transmitter power supply module (TxPSU), connect as shown. The output is a 24V nominal (unregulated, 19 to 28V DC), supply at 22mA max. Only one TxPSU is supported, do not fit in slot 3 if one is already fitted in slot 2.

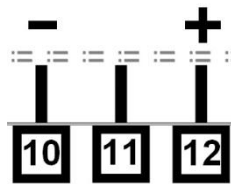

Figure 37. Plug-in Module Slot 3 - Transmitter Power Supply Module

Plug-in Slot A Connections

A selection of plug-in modules are available for Module Slot A. They can be fitted during manufacture, or purchased and fitted later by the user. Depending on their functions, they are setup Input or Communications configuration sub-menus. Connect as illustrated below.

Plug-in Module Slot A – Basic Auxiliary Input Module

If fitted with a basic auxiliary mA/V DC analogue input module, connect as shown. Isolated from all inputs/outputs. Consider using the 2nd auxiliary input (if available) instead, as this has additional features and leaves plug-in module slot A free for other modules.

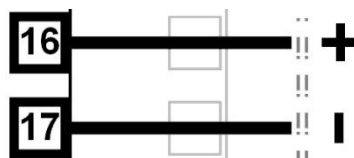

Figure 38. Plug-in Module Slot A – Basic Auxiliary Input Module

Plug-in Module Slot A - Ethernet Communications Module

If fitted with the Ethernet communication module, the communications protocol available is Modbus TCP. Isolated from all inputs/outputs. If necessary, cut out the removable panel to access the RJ45 connector through the top of the case. No rear connections are required.

Plug-in Module Slot A - RS485 Serial Communications Module

If fitted with the RS485 serial communication module, the protocol used is Modbus RTU. Isolated from all inputs/outputs. Carefully observe the polarity of the A (Rx/Tx +ve) and B (Rx/Tx -ve) connections.

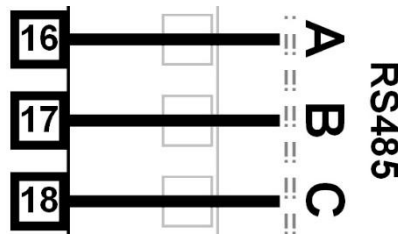

Figure 39. Plug-in Module Slot A – RS485 Serial Communications Module



CAUTION: External computing devices connected to the communications port should comply with the standard, UL 60950.

Plug-in Module Slot A – Single Digital Input Module

If a digital input module is fitted, it provides a fully isolated input that is held high via a pull-up resistor. The input can be connected to either to voltage free contacts (e.g. from a switch), or a TTL compatible signal.

Logic High = Open contacts (>5000Ω) or 2 to 24VDC signal.

Logic Low = Closed contacts (<50Ω) or -0.6 to +0.8VDC signal.. Connect as shown.



Figure 40. Plug-in Module Slot A – Digital Input A Module

Option C Connections

Option C offers a factory fitted multiple digital input option. The board also accommodates the USB port if that is option is fitted. The USB port does not have connections on the rear terminal, it is accessed via the front panel.

Option C Connections – Multiple Digital Input Module

If the Multiple Digital Input option is fitted, the connections are as illustrated. The 8 opto-isolated inputs each have a positive input terminal and share a common negative terminal. The inputs are held high with internal pull-up resistors, so may be connected to either voltage free contacts (e.g. from a switch), or TTL compatible signals:

Logic High = Open contacts ($>5000\Omega$) or 2 to 24VDC signal.

Logic Low = Closed contacts ($<50\Omega$) or -0.6 to +0.8VDC signal.

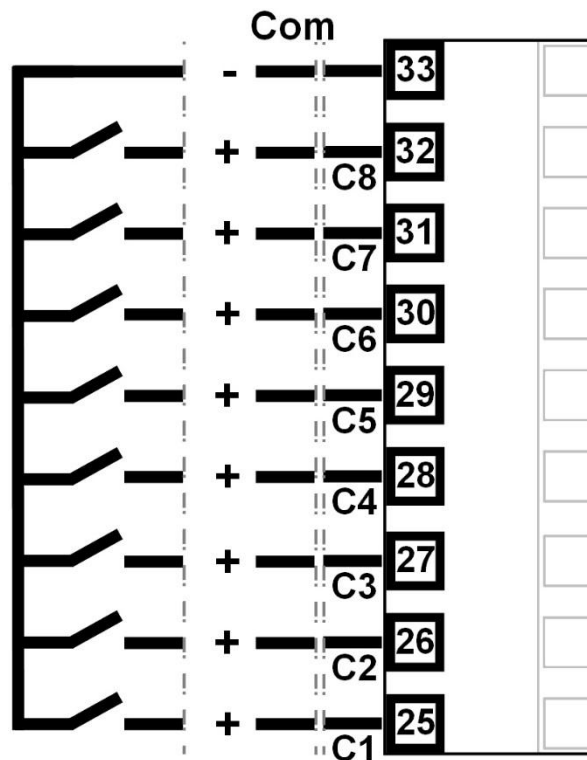

Figure 41. Option C - Multiple Digital Inputs C1 to C8

Special Wiring Considerations for Valve Motor Control

Valve Motor Drive (VMD) controllers require two identical outputs to be assigned to position the valve. One to open and one to close the valve. These outputs can be two single relays, two triacs, two SSR drivers or one dual relay, but it is recommended to use two single relays (SPDT change-over contacts), and to interlock the relay wiring as shown. This prevents both motor windings from being driven at the same time, even under fault conditions.

Switching actuators directly connected to the valve motor must only be used up to half of their rated voltage (see **CAUTION** below). The internal relay and triac outputs are rated at 240VAC, so the maximum motor voltage when using them in this way is therefore 120V unless interposing relays are used. Interposing relays or other devices used to control the valve must themselves be rated for twice the motor supply voltage.

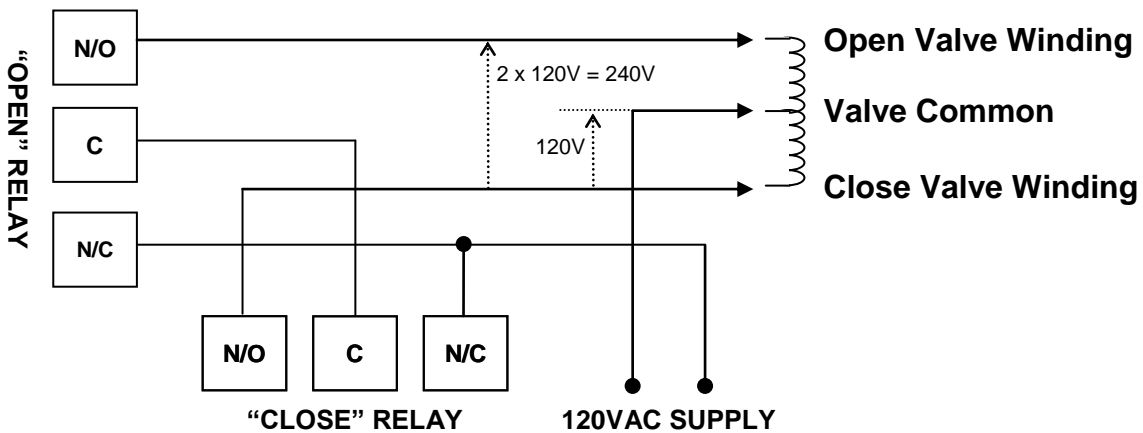

Figure 42. Interlocking of Valve Motor Drive Relays



CAUTION: The windings of a valve motor effectively form an autotransformer. This has a voltage doubling effect when power is applied to either the Open or Close terminal, causing twice the supplied voltage at the other terminal. For this reason, switching devices directly connected to the valve motor must only be used up to half of their rated voltage. The maximum motor voltage when using the internal relays/triacs is therefore 120V unless interposing relays are used. Interposing relays or other devices used to control the valve must themselves be rated for twice the motor supply voltage.

5 Powering Up



CAUTION: Ensure safe wiring practices have been followed. When powering up for the first time, disconnect the output connections. The instrument must be powered from a supply according to the wiring label on the side of the unit. The supply will be either 100 to 240V AC, or 24/48V AC/DC powered. Check carefully the supply voltage and connections before applying power

Powering Up Procedure

At power up, a self-test procedure is automatically started, during which a splash screen is displayed and the LED indicators are lit. At the first power up from new, a Setup Wizard runs to assist configuration of basic applications (*refer to the Setup Wizard section on page 43*). At all other times, the instrument returns to the normal operation mode once the self-test procedure is complete.

Front Panel Overview

The illustration below shows an instrument fitted with the optional USB socket located to the right of the four keypad buttons. Clean the front panel by washing with warm soapy water and dry immediately. If the USB option is fitted, close the port cover before cleaning.

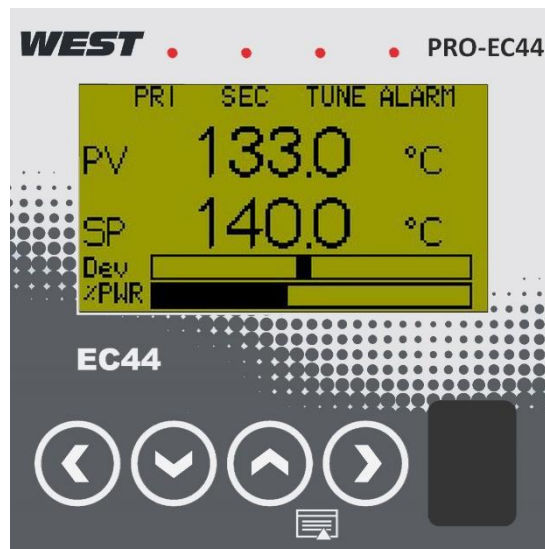

Figure 43. A Typical Front Panel

Display







The instrument has a 160 x 80 pixel monochrome graphical display with dual colour (red/green) backlight. The main display typically shows the process variables, setpoints, power / deviation bar graphs or graphical trends during normal operation. There are recorder and profile status screen. The top line of the display has labels for the 4 LED indicators. If desired, the backlight colour can be changed to indicate the presence of an active alarm or latched output. *Refer to the Display Configuration section - page 59*

LED Functions

There are four red LEDs that by default indicate the status of the primary & secondary outputs, automatic tuning and alarm status. The top line of the graphical display has four labels for LED indicators. The function of these LEDs and their display labels can be changed using the PC configuration software. The information in this manual assumes standard functions for these LEDs.

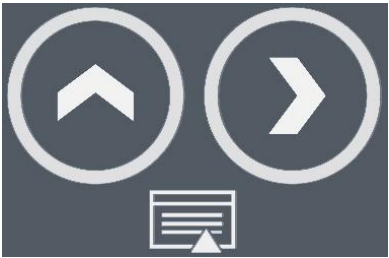

Keypad Functions & Navigation

Each instrument has four keypad switches, which are used to navigate through the user menus and adjust the parameter values. In configuration screens, a context sensitive scrolling help text is displayed that guides the user about the function of the keys.

Keypad Button Functions	
Button	Function
	Moves backwards to the previous parameter or screen in the current mode. Holding this key down for more than 1 second skips immediately to the previous screen accepting ALL values as shown. CAUTION: If editing a parameter, ensure that the current (highlighted) parameter value is correct before pressing the key as this action will update and store the value displayed.
	In menus and configuration choice screens, this key moves to the next item on the list. Editable values can be decreased by pressing this key. Holding the key down speeds up the change. In Trend views this key moves the Cursor Line back through the stored data points
	In menus and configuration choice screens, this key moves to the previous item on the list. Editable values can be increased by pressing this key. Holding the key down speeds up the change. In Trend views this key moves the Cursor Line forward through the stored data points
	Moves forwards to the next parameter or screen in the current mode. Holding this key down for more than 1 second skips immediately to the next screen accepting ALL values as shown. CAUTION: If editing a parameter, ensure that the current (highlighted) parameter value is correct before pressing the key as this action will update and store the value displayed.
	Pressing the  key while holding down the  key causes the instrument to move up one menu level. From Operation Mode and in most menus, this will result in entry to the Main Menu. From sub-menus, it is necessary to carry out this sequence more than once to reach the main menu. CAUTION: If editing a parameter, ensure that the current (highlighted) parameter value is correct before pressing the key as this action will update and store the value displayed.

6 Messages & Error Indications

Plug-in Module Problems

If an invalid or unknown module is detected in one of the plug-in module slots during the power-up self-test, the message “**Fault Found, Press  for details**” is shown. This is followed by “**Replace faulty module in Module Slot *n*, Press **,” (where *n* is the faulty slot location). The Service Contact information is displayed next showing details of who to contact if a fault persists

Replace the module in slot “*n*”. If this does not solve the problem, return the instrument for investigation.



CAUTION: Do not continue using the product until the the error is resolved.

Sensor Break Detection

Whenever a problem is detected with a process variable or auxiliary input connection, the displayed value for that input is replaced with the word “**OPEN**”; except in Ratio control where an open input 1 or 2 is shown as “**x1-Open**” or “**x2-Open**”. See Redundant Input (page 83) to protect critical processes from sensor faults.

This may be the result of a failed sensor, a broken connection or an input circuit fault. In this condition, the control outputs go to the pre-set power value (see *Control Configuration* – page 50).



CAUTION: Correct the signal/wiring problem to continue normal operation.

Un-Calibrated Input Detection

The instrument is fully calibrated during manufacture. If a fault occurs and calibration data is lost, the process input displays are replaced with the word “**ERROR**” and error is shown instead of “Calibrated” for effected inputs in Service & Product Information mode. In this condition, the control outputs go to the pre-set power value (see *Control Configuration* – page 50).



CAUTION: Perform a full base calibration of the input before continuing normal operation (see page 72). If the problem persists, return the instrument for servicing.

PV Over-range or Under-range Indication

If a measured process input value is more than 5% above than the Scaled Input Upper Limit, its value is replace by the word “**HIGH**” to indicate that it is out of range.

If a measured process input value is more than 5% below than the Scaled Input Lower Limit, its value is replaced by the word “**LOW**” to indicate that it is out of range.

Auxiliary Input Over-range or Under-range Indication

If the auxiliary Remote Setpoint input is more than 5% above than the Auxiliary Input Upper Limit, its value is replaced by the word "**HIGH**" to indicate that it is out of range.

If the auxiliary Remote Setpoint input is more than 5% below than the Auxiliary Input Lower Limit, its value is replace by the word "**LOW**" to indicate that it is out of range.

Cascade-Open

"**Cascade Open**" is shown on the main screen if the internal link has be severed between cascaded master and slave control loops. This mode should only be used for diagnostics and slave tuning. Close the cascade for proper operation. Refer to the Cascade Control section (page 78) for more information.

Profile Not Valid

If the user attempts to run a profile that would take the setpoint beyond the current setpoint limits, the profile will not run and the message "**Profile Not Valid**" is displayed at the bottom of the profile status screen.

USB Data Transfer Failure message

If the instrument cannot successfully write to the USB memory stick, the message "**Data Transfer Failure**" will be displayed. Check that there is adequate disk space on the memory stick, then retry.

If the instrument cannot successfully read data from the USB memory stick, the message "**Data Transfer Failure**" will also appear. Check that this operation would not cause the maximum number of profiles and/or segments to be exceeded then retry.

Getting Help

First Level Support

If the errors persist or other problems are encountered, refer your supplier for first level support. This includes help with configuration, tuning, servicing and replacement modules.

Second Level Support

If your supplier is unable to assist or cannot be contacted, check the Service & Product Information screen on the main menu for details of who to contact.

Third Level Support

If further assistance is required, contact the nearest company from those listed on the back page of this manual.

Servicing

If you need to return your instrument for servicing, contact your supplier or check the Service & Product Information screen on the main menu for instructions for its return.

7 Application Setup

Before beginning configuration, consider how the controller will be used in your application. For instance, how many control loops are needed, is cascade or ratio control required, will the unit control a valve motor, do you need setpoint profiling etc. Consideration should also be given to the output types, alarms and tuning method.

This section is intended to help with this process, guiding you through the major configuration settings. Additional information can be found in the relevant sections of this manual, including the glossary, configuration menus, and dedicated sections for major features. These are listed in the table of contents.

Pre-commissioning Considerations

An easy Setup Wizard is available for basic applications (see page 43) where the most commonly required parameters are present for adjustment in turn. The wizard has a sub-set of the full configuration menu options. For more complex applications where the wizard is not sufficient, consideration must be given to the following fundamental questions:

If fitted, how will the 2nd input be used?

- One loop only (if the 2nd input not fitted or not used in this application)
- Two independent control loops (see page 50).
- Valve feedback for loop 1 (see page 85 **Error! Bookmark not defined.**).
- A “redundant” backup for the 1st input (see page 83).
- Cascaded with the first control loop (see page 78).
- A reference input for ratio control (see page 81).

How will the instrument physically control the process?

- Primary only or primary & secondary control outputs (see page 210).
- Direct valve motor drive outputs (see page 84).

The table below shows the main input and control configuration settings for these application types (see page 45 for the configuration menus).

Process Type* (only if 2nd input fitted)	Loop 1 / Master		Loop 2 / Slave	
	Control Configuration: Control Select	Control Configuration: Control Type	Control Configuration: Control Select	Control Configuration: Control Type
One Loop*	Standard PID	Primary Only		
Input 2 Configuration Input 2 Usage = Not Used	Control Select = Control Standard	Control Type = Single ----- Primary / Secondary Control Type = Dual		
	Valve Motor Drive Control Select = VMD (TPSC) Control			

Process Type* (only if 2nd input fitted)	Loop 1 / Master		Loop 2 / Slave	
	Control Configuration: Control Select	Control Configuration: Control Type	Control Configuration: Control Select	Control Configuration: Control Type
Two Loops* Input 2 Configuration Input 2 Usage = Standard	<u>Standard PID</u> Control Select = Control Standard	<u>Primary Only</u> Control Type = Single ----- <u>Primary / Secondary</u> Control Type = Dual	<u>Standard PID</u> Control Select = Control Standard	<u>Primary Only</u> Control Type = Single ----- <u>Primary / Secondary</u> Control Type = Dual
+Feedback* Input 2 Configuration Input 2 Usage = Feedback	<u>Valve Motor Drive</u> Control Select = VMD (TPSC) Control		<u>Valve Motor Drive</u> Control Select = VMD (TPSC) Control	
Redundant* Input 2 Configuration Input 2 Usage = Redundant Input	<u>Standard PID</u> Control Select = Control Standard	<u>Primary Only</u> Control Type = Single ----- <u>Primary / Secondary</u> Control Type = Dual		
Cascade* Input 2 Configuration Input 2 Usage = Standard AND Loop 1 / Master Configuration Control Mode = Cascade			<u>Standard PID</u> Control Select = Control Standard	<u>Primary Only</u> Control Type = Single ----- <u>Primary / Secondary</u> Control Type = Dual
Ratio* Input 2 Configuration Input 2 Usage = Standard AND Loop 1 / Master Configuration Control Mode = Ratio	<u>Standard PID</u> Control Select = Control Standard <u>Valve Motor Drive</u> Control Select = VMD (TPSC) Control		<u>Valve Motor Drive</u> Control Select = VMD (TPSC) Control	

Which outputs will be used for control, and are alarms or event outputs needed?

- Output configuration (see page 56).
- Alarms & Profile Events (see page Alarm Types 207 & 225).

What are the sources for the setpoints?

- Local setpoint(s) only, or a remote setpoint input (see page 216 & 227).
- Profile Control (see page 87).

Is Input re-configuration required?

- Analogue input calibration & scaling (see page 70).
- Digital input functions (see page 75).

Which other features are to be used?

- Data Recorder (see page 97).
- Serial Communications (see page 109).
- USB Interface (see page 96).

Once you have an understanding of your application and how the controller will be used, continue on to the configuration and use section below.



CAUTION: Configuration & commissioning must be completed before proceeding to Operation Mode. It is the responsibility of the installing engineer to ensure that the configuration is safe.

8 Operation and Configuration Menus

This section contains information on all of the controller's modes and the configuration menus.

Operation Mode

This is the mode used during normal operation of the instrument. It can be accessed from the Main Menu, and is the usual mode entered at power-up. The available displays are dependent upon the features/options fitted and the way in which it has been configured.

The Base screen is the usual screen displayed during operation. It provides "at a glance" information about the process. The Profile Status screen shows similar information when using profiles.

Subsequent screens allow the display and selection/adjustment* of the setpoints. From display configuration, a selection of other parameter screens can be made available for operator selection/adjustment*. These include: profile control; cascade open/close; auto/manual control; setpoint ramp rate; setpoint source; control enable; clear latched outputs; data recording & status trend views. Optional operator mode screens are marked ■ in the screen lists.

Some screens will persist until the user navigates away, others will 'time-out' back to the base screen.

* If required, all Operation Mode parameters can be made read only (see *Display Configuration on page 59***Error! Bookmark not defined.**). Otherwise parameters such as setpoints can be adjusted within their configured limits.



WARNING:

DURING NORMAL USE, THE USER MUST NOT REMOVE THE CONTROLLER FROM ITS HOUSING OR HAVE UNRESTRICTED ACCESS TO THE REAR TERMINALS, AS THIS WOULD PROVIDE POTENTIAL CONTACT WITH HAZARDOUS LIVE PARTS.







CAUTION: Set all Configuration parameters as required before starting normal operations. It is the responsibility of the installing engineer to ensure that the configuration is safe for the intended application.

Navigating and Adjusting Values in Operator Mode

Press  to move forward or  to move backwards through the available screens.

When a displayed value can be adjusted, use  or  to change its value.

The next/previous screen follows the last parameter. If no further changes are needed, hold down  or  for >1sec to skip straight to the next/previous screen accepting **ALL** values shown.

In Trend Views, pressing  or  moves the cursor line back and forward through the last 240 data points.

OPERATION MODE SCREEN SEQUENCE

All possible screens are listed below. The sequence shown depends on the configuration and status. E.g. settings for "Loop 2" only apply if 2nd input is fitted and configured for 2-loop control.

■ *Some screens are only shown if set to do so in Display Configuration.*

After 2 minutes without key activity, the most screens revert to the Base Operating Screen. Screens marked ⌚ do not revert automatically. They remain displayed until the user navigates away.

⌚ Calibration Check Due Warning

If a Calibration Reminder is set and the due date has passed this will be shown at every power up, and repeated once per day. Press ⏻ to acknowledge and continue using the instrument temporarily without recalibration. Change the due date or disable the reminder to cancel the warning. This feature is only possible if the recorder is fitted. It is enabled in Input Configuration.

⌚ Single Control Loop: Normal Operation

<p>LED Indicators</p> <p>Process Variable Value</p> <p>Effective Actual Setpoint Value</p> <p>Control Deviation Graph (scaled ±5% of input span)</p>		<p>LED Function Labels</p> <p>Engineering Units</p> <p>Power Graph (0-100% primary, ±100% primary & secondary)</p>
--	--	---

1-LOOP OPERATION

Default LED indicator functions are PRI, SEC, TUNE & ALARM - the functions and their labels can be altered only with the PC configuration software.

In valve motor drive mode, the power bar-graph is replaced by valve **Open / Stop / Close** unless the 2nd input is used for position feedback, where it shows **0 to 100%** valve position.

In manual mode the effective setpoint is replaced by the **%Manual Power** and the label "**MAN**".

In manual mode with valve motor drive the setpoint is replaced by valve **Open / Stop / Close**.

If control is disabled the effective setpoint value is replaced by "**OFF**".

⌚ Two Control Loops: Normal Operation

<p>LED Indicators</p> <p>Process Variable* & Actual Setpoint Values*</p> <p>Loop Description*</p> <p>Engineering Units*</p>		<p>LED Function Labels</p> <p>Indicators for Alarm and Remote Setpoint active*</p> <p>Control Deviation (±5% of span) & Power Graphs*</p>
---	--	--

2-LOOP OPERATION

* = in loop 1 & 2 screen area

Default LED indicator functions are PRI 1, PRI 2, TUNE & ALARM - the functions and their labels can be altered only with the PC configuration software.

In valve motor drive mode, the power bar-graph is replaced by valve **Open / Stop / Close**.

In manual mode the effective setpoints are replaced by the **%Manual Power** and the label "**MAN**".

In manual mode with valve motor drive the setpoint is replaced by valve **Open / Stop / Close**.

If control is disabled the effective setpoint value of that loop is replaced by "**OFF**".

Cascade Control: Normal Operation

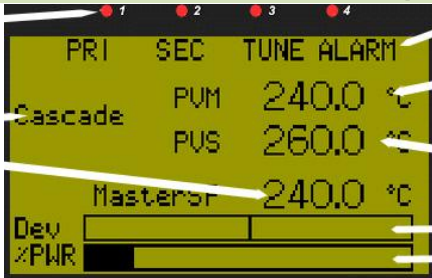
<p>LED Indicators</p> <p>Cascade Status</p> <p>Master Setpoint (Slave SP if Cascade Open)</p>		<p>LED Function Labels</p> <p>Master Process Value</p> <p>Slave Process Value</p> <p>Control Deviation (±5% of span) & Power Graphs</p>
--	---	---

CASCADE CONTROL

Default LED indicator functions are PRI, SEC, TUNE & ALARM - the functions and their labels can be altered only with the PC configuration software.

Cascade Status shows "Cascade" when cascade is operating normally and "Cascade Open" when the master / slave link has been disconnected. Master & Slave Process Values.

In valve motor drive mode, the power bar-graph is replaced by valve **Open / Stop / Close**.

In manual mode the slave setpoint is replaced by the **%Manual Power** and the label "MAN".

In manual mode with valve motor drive the slave setpoint is replaced by valve **Open / Stop / Close**.

If control is disabled the effective master setpoint value is replaced by "OFF".

Ratio Control: Normal Operation

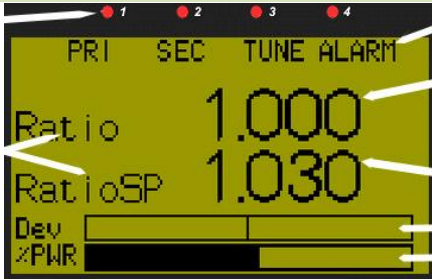
<p>LED Indicators</p> <p>Ratio & Setpoint Labels</p>		<p>LED Function Labels</p> <p>Relative Process Value</p> <p>Relative Setpoint</p> <p>Control Deviation (±5% of span) & Power Graphs</p>
--	--	---

RATIO CONTROL

Default LED indicator functions are PRI, SEC, TUNE & ALARM - the functions and their labels can be altered only with the PC configuration software.

In manual mode the ratio setpoint value is replaced by the **%Manual Power** and the label "MAN".

If control is disabled the effective setpoint value is replaced by "OFF".

Operator Profile Control	<p>Allows the operator to control the defined profiles.</p> <p>If a profile is running, the choices are: Do Nothing; Abort Profile (end immediately); Jump to Next Segment; Hold Profile or Release Hold.</p> <p>If no profile is running, the choices are: Do Nothing; Run Profile; End Profile Control (returns to standard controller operation) or Select Profile.</p> <p>only shown if set to do so in Display Configuration.</p>
---------------------------------	---

Single Control Loop: Profiler Status

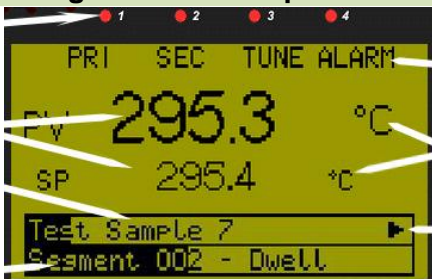
<p>LED Indicators</p> <p>Process Value & Setpoint</p> <p>Profile Name & Progress</p> <p>Segment No, Type & Progress (or Delayed Start Time)</p>		<p>LED Function Labels</p> <p>Engineering Units</p> <p>Profile Status Indicator:</p> <p>▶ Run, Held, ■ Stopped</p>
---	---	--

1-LOOP PROFILE STATUS

Default LED indicator functions are as shown in the initial base screen.



In manual mode the effective setpoint is replaced by the **%Manual Power** and the label "MAN".





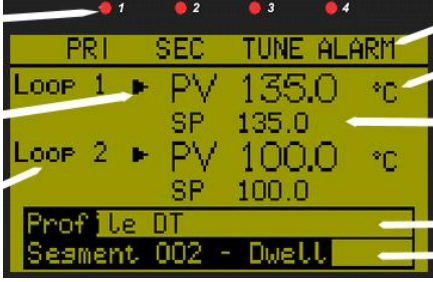

In manual mode with valve motor drive the setpoint is replaced by valve **Open / Stop / Close**.













If control is disabled the effective setpoint value is replaced by "OFF".

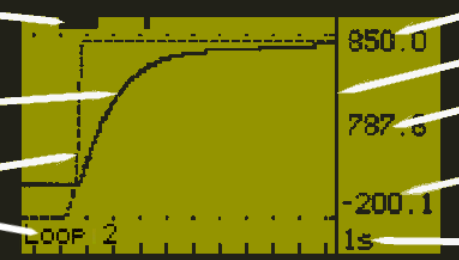

Note: If power is lost when a profile is running and recovery is set to continue, the bar-graph re-starts from the beginning but the overall time remains correct.

 Two Control Loops: Profiler Status	
<p>LED Indicators</p> <p>Profile Status Indicators*:</p> <p>▶ Run, Held, ■ Stopped</p> <p>Loop Descriptions*</p> <p><small>* = in loop 1 & 2 screen area</small></p>	 <p style="text-align: center;">2-LOOP PROFILE STATUS</p>
	<p>LED Function Labels</p> <p>Engineering Units*</p> <p>Process Variable Values & Setpoints*</p> <p>Profile Name & Progress</p> <p>Segment No. Type & Progress (or Delayed Start Time)</p>
<p>Default LED indicator functions are as shown in the initial base screen.</p> <p>In manual mode the effective setpoints are replaced by the %Manual Power and the label "MAN".</p> <p>In manual mode with valve motor drive the setpoints are replaced by valve Open / Stop / Close.</p>	
<p> Note: <i>If power is lost when a profile is running and recovery is set to continue, the bar-graph re-starts from the beginning but the overall time remains correct.</i></p>	
<p>Event Status</p>	<p>Lists all configured profile events with their current status (Active or Inactive) – <i>Shown only when the instrument is in profiler mode.</i></p>
<p>Cascade Mode</p>	<p>Allows the user to open the cascade, breaking the master-slave link for commissioning & tuning.</p> <p>CAUTION: Return to Cascade-CLOSE when finished!</p> <p>■ <i>only shown if set to do so in Display Configuration.</i></p>
<p>Auto/Manual Control Selection – Loop 1 (or Cascade Slave)</p>	<p>Switches loop 1 (or the cascade slave loop) between automatic and manual control modes. Switching between these modes uses "Bumpless Transfer".</p> <p>■ <i>only shown if set to do so in Display Configuration.</i></p> <p>When using standard PID control, Manual mode replaces the Setpoint display with a -100 to 100% power output level value, labelled "Man". The ⏪ or ⏩ keys are used to adjust the manual power value.</p> <p>When using VMD control, Manual mode replaces the Setpoint display with the valve movement status (Opening, Closing or Stopped), labelled "Man". The ⏪ key opens the valve and the ⏩ key closes the valve.</p> <p>If Manual control is selected when in Cascade mode, the slave loops % power value shown. This is the power output fed directly to the control actuator (e.g. power to the heater elements).</p> <p>CAUTION: Manual mode overrides the automatic control loop. It also ignores any output power limits, valve open/close limits and the control enable/disable setting. The operator is responsible for maintaining the process within safe limits.</p> <p> Note: <i>In Manual mode a running profile will hold until automatic control is reselected.</i></p>
<p>Setpoint Value Display & Adjustment – Loop 1</p>	<p>View and adjust the main and alternate setpoints for loop 1 (or the master loop in cascade mode). The setpoints can be set to any value within the setpoint limits set in Control Configuration. View and adjust local (internal) setpoints for the loop. The currently selected setpoint is marked as "active". <i>If the alternate setpoint is remote it cannot be adjusted from the keypad.</i></p>



Setpoint Ramp Rate – Loop 1	<p>The setpoint ramp rate adjustment for loop 1. Adjustable between 0.1 and 9999.0 display units per hour. When set to “OFF”, setpoint changes will step immediately to the new value - only shown if set to do so in Display.</p> <p> Note: <i>If the setpoint ramp feature is used, it disables pre-tune completely, and if self-tune is used, it will only calculate new terms after the ramp has completed and the setpoint is constant.</i></p>
Select Active Setpoint – Loop 1	<p>Select if the main or alternate setpoint is to be the “active” setpoint for loop 1 (or the master loop in cascade mode). only shown if set to do so in Display.</p>
Control Enable – Loop 1	<p>Enables or disables loop 1 control outputs. When disabled, the primary and secondary control outputs of loop 1 are set to zero 0% (unless manual mode has been selected) and the setpoint value is replaced by “OFF”.</p> <p>only shown if set to do so in Display.</p> <p>CAUTION: The instrument cannot control the process when disabled.</p>
Auto/Manual Control Selection – Loop 2	<p>Switches loop 2 between automatic and manual control modes. Switching between these modes uses “Bumpless Transfer”.</p> <p>only shown if set to do so in Display Configuration.</p> <p>When using standard PID control, Manual mode replaces the Setpoint display with a -100 to 100% power output level value, labelled “Man”. The  or  keys are used to adjust the manual power value.</p> <p>When using VMD control, Manual mode replaces the Setpoint display with the valve movement status (Opening, Closing or Stopped), labelled “Man”. The  key opens the valve and the  key closes the valve.</p> <p>CAUTION: Manual mode overrides the automatic control loop. It also ignores any output power limits, valve open/close limits and the control enable/disable setting. The operator is responsible for maintaining the process within safe limits.</p> <p> Note: <i>In manual mode a running profile will hold if it is controlling the setpoint of loop 2, until automatic control is reselected.</i></p>
Setpoint Value Display & Adjustment – Loop 2	<p>View and adjust the main and alternate setpoints for loop 2. The setpoints can be set to any value within the setpoint limits set in Control Configuration. View and adjust local (internal) setpoints for the loop. The currently selected setpoint is marked as “active”.</p> <p><i>If the alternate setpoint is remote it cannot be adjusted from the keypad.</i></p>
Setpoint Ramp Rate – Loop 2	<p>The setpoint ramp rate adjustment for loop 2. Adjustable between 0.1 and 9999.0 display units per hour. When set to “OFF”, setpoint changes will step immediately to the new value - only shown if set to do so in Display.</p> <p> Note: <i>If the setpoint ramp feature is used, it disables pre-tune completely, and if self-tune is used, it will only calculate new terms after the ramp has completed and the setpoint is constant.</i></p>
Select Active Setpoint – Loop 2	<p>Select if the main or alternate setpoint is to be the “active” setpoint for loop 2 (or the master loop in cascade mode). only shown if set to do so in Display.</p>
Control Enable – Loop 2	<p>Enables or disables loop 2 control outputs. When disabled, the primary and secondary control outputs of loop 2 are set to zero 0% (unless manual mode has been selected) and the setpoint value is replaced by “OFF”.</p> <p>only shown if set to do so in Display Configuration.</p> <p>CAUTION: The instrument cannot control the process when disabled.</p>
Alarm Status	<p>Lists the status of the alarms. Shown if any of the 7 alarms is active.</p> <p><i>The titles “Alarm n” can be replaced with the PC configuration software to a user defined 8 character name for each alarm.</i></p>

Clear Latched Outputs	Hold down  or  for 3 seconds to clear the selected latched output – An output will only reset if the condition that caused it to latch on is no-longer present. only shown if set to do so in Display Configuration.	
Recorder Memory Full Warning	Indicates that the Data Recorder memory is full and that recording has either stopped or is overwriting older data if in FIFO recording mode.	
Manual Recording Trigger	Set the manual recording trigger on or off. only shown if set to do so in Display Configuration.  Note: Setting the manual trigger to off may not stop the recording. Data recording will still take place if another recording trigger is active.	
Recorder Status Information	Shows the recording status (“Stopped” or “Recording”); icons for any active recording triggers; the recording mode (FIFO or Record Until Memory Is Used); the approximate recording time remaining* and a memory usage bar-graph. In FIFO mode, the time remaining is replaced with “FIFO” when full. <i>*If the status of alarms is recorded, extra samples are taken when the alarms change state reducing the available recording time. Take this into account when determining if there is sufficient memory available.</i> <div style="text-align: center;"> Icons for Active Recorder Triggers     Manual Record ON Digital Input Record ON Profile Record ON Alarm Record ON </div>	
 Trend Views: One per Control Loop		
Active Alarm(s) Process Variable Trend Setpoint Trend (dotted) Loop No. & Time Markers (10 samples per marker)		Trend Upper Scale Value Cursor Line PV Value At Cursor Line Trend Lower Scale Value Sample Interval (or time at cursor line)
TREND VIEW		
Trend views can be shown of each loop. They are auto-scaling graphs with alarm indication and other process information. The trend can be set to show the process variable only; the process variable & setpoint (dotted line), or the minimum and maximum value of the process variable measured since the last sample. Any active alarm(s) are indicated above the graph.		
Graph types and data sample intervals (1 sec to 30 mins) are set in Display Configuration.		
Trend scale values adjust automatically to visible data (between 2 to 100% of the input span).		
120 data points are visible. Pressing  or  moves the cursor line back through the graph to examine up to 240 data points. The process variable value of that data point is shown to the right of the cursor line and the sample rate value is replaced by the time represented by the cursor position.		
only shown if set to do so in Display Configuration.		
	Note: Trend data is not retained at power down or if the sample interval is changed.	
- Custom Display Screens	You can copy up to 50 configuration menu parameters into normal operation mode using the PC software. These extended operator mode screens appear at the end of the normal sequence. If the parameter is normally displayed on screen with another parameter, both parameters will appear.  Note: In this mode screens are not pass-code protected , they can be freely adjust. It is possible to make operation mode “read only”, including any custom screens from Display Configuration.	

Main Menu

This menu is used to access the various features and configuration settings. The available menus are dependent upon the features and options fitted and how it has been configured.

Entry into the Main Menu

Holding down  and pressing  from Operation Mode and most other screens will cause the unit to enter the Main Menu. Each time this key press sequence is made, the instrument moves to the next menu level above. Sub-menu levels will require this sequence to be pressed more than once in order to reach the Main Menu.

Navigating the Main Menu









Once in the Main Menu, press  or  to select the required option

Press  to enter the chosen menu.

Scrolling “Help Text” is shown at the bottom of the screens to aid navigation.

Unlock Codes

To prevent unauthorised entry, most menus require a pass-code (1 to 9999) to gain entry. These menus are indicated by the symbol . The codes can be viewed and changed from the Lock Code Configuration sub-menu of Configuration Mode. The factory default unlock code is 10 for all modes but for security, these should be changed to new values. If the Configuration Mode lock code is lost, refer to Lost Lock Codes on page 69.

MAIN MENU OPTIONS	
Operation Mode	The normal operation screens, displaying the process and setpoint values; selection/adjustment of the setpoints; auto/manual control; alarm/event status; trend views; data recorder and profile information.
Setup Wizard	 An easy, step-by-step parameter setup for simple applications.
Supervisor Mode	 If configured from the PC software, a sub-set of up to 50 Configuration screens can be accessed.
Configuration Menu	 Accesses the sub-menus for Inputs; Control Loops; Outputs; Alarms; Communications; Recorder; Clock; Display and Lock Codes. There is an option to Reset to Defaults wiping all user settings from the instrument.
Automatic Tuning	 Selection of Pre-tune, Self-tune and Auto Pre-tune for the control loops.
USB Menu	 Uploading/downloading instrument configuration, profile information and data recordings.
Recorder Control	 Manually starting, stopping and deleting recordings.
Profile Setup	 Setting global parameters for all profiles; plus profile creation, editing and deletion.
Profile Control	 Selection of profiles. Running, holding or aborting the selected profile.
Service & Product Information	Contact information for service/support, followed by instrument information, including features and plug-in modules installed, serial number, firmware version etc.

Setup Wizard

An easy Setup Wizard runs automatically at first ever power-up. Follow the Wizard to setup parameters required for basic applications. The parameters covered by the Setup Wizard are marked with a **w** in the following sections covering the configuration mode sub-menus. Once completed, the Setup Wizard exits to Operation Mode.

The Wizard can be run again at any time from the Main Menu. An option to reset all parameters to default (*recommended*) is offered when manually running the wizard.





CAUTION: Resetting defaults all parameters, not just those covered by the quick setup wizard. For more complex applications the user may have to reconfigure other Configuration Menu settings before using the instrument.

Experts or users with more complex applications can select the parameters they wish to set-up directly from the Configuration Menus bypassing the Wizard.

Manual entry to the Setup Wizard

To select the Setup Wizard from the Main Menu.

Hold down  and press  to enter the Main Menu.



Press  or  to select Setup Wizard.





Note: *With the exception of the first ever power-up, entry into this mode is security-protected by the Setup Wizard Lock Code. Refer to the Lock Code Configuration sub-menu.*

Press  to enter the Setup Wizard.

Navigating in the Setup Wizard

Press  to move forward, or  to move backwards through the screens.

Press  or  to change the value as required.

Holding down  or  for more than 1 second skips immediately to the next/previous screen accepting **ALL** values as shown.

Hold down  and press  to return to the Main Menu

Scrolling “Help Text” is shown at the bottom of the screens to aid navigation.

🔒 SETUP WIZARD SCREENS	
Setup Wizard Unlocking	w Enter correct code number to access Setup Wizard. <i>Factory Default value is 10.</i>
- key screens from Configuration Menu (those marked w)	w Press  to select each major configuration parameter in turn. Follow on-screen prompts to alter the values.
Setup Wizard Completed	w Confirms completion of the Setup Wizard. Exits to Operation Mode.

Supervisor Mode

This mode is only available if it has been configured from the PC software. Its purpose is to allow selected operators access to a lock-code protected sub-set of the configuration parameters, without providing them with the higher level configuration menu unlock code.

The PC software can copy up to 50 parameters from configuration menus for inclusion in the supervisor mode screen sequence. If the parameter is normally displayed on screen with another parameter, both parameters will appear. It is not possible to configure supervisor mode screens without using the software.

Entry into Supervisor Mode



CAUTION: Adjustments to these parameters should only be performed by personnel competent and authorised to do so.

Supervisor Mode is entered from the Main Menu

Hold down  and press  to enter the Main Menu.



Press  or  to select Supervisor Mode





Note: *Entry into this mode is security-protected by the Supervisor Mode Lock Code. Refer to the Lock Code Configuration sub-menu.*

Press  to enter the Supervisor Mode.

Navigating in Supervisor Mode

Press  to move forward, or  to move backwards through the screens.

Press  or  to change the value as required.

The next/previous screen follows the last parameter. If no further changes are required, hold down  or  >1sec to skip straight to next/previous screen accepting **ALL** values shown.

Hold down  and press  to return to the Main Menu

Scrolling “Help Text” is shown at the bottom of the screens to aid navigation.

🔒 SUPERVISOR MODE SCREENS	
Supervisor Mode Unlocking	If Supervisor Mode is configured, enter correct code number to continue. <i>Factory Default value is 10.</i>
- Supervisor Mode Screens ...	Press  to select each selected parameter in turn. Follow on-screen prompts to alter the values.

Configuration Menu

This menu can be used as an alternative to the more limited Setup Wizard when the instrument is configured for the first time in more complex applications, or when further changes are required to the instruments settings. The configuration menu contains a number of sub-menus that allow access to all of the available parameters. The correct settings must be made before attempting to use the instrument in an application. Screens marked **w** are also shown in the Setup Wizard.

Entry into the Configuration Menu



CAUTION: Adjustments to these parameters should only be performed by personnel competent and authorised to do so.

Configuration is entered from the Main Menu

Hold down  and press  to enter the Main Menu.

Press  or  to select Configuration Menu



Note: *Entry into this mode is security-protected by the Configuration Menu Lock Code. Refer to the Unlock Code section for more details.*

Press  to enter the Configuration Menu.

Navigating the Configuration Menu

Configuration contains sub-menus to set-up the Inputs; Control; Outputs; Alarms; Communications; Recorder; Clock; Display and Lock Codes.

There is also an option to reset the instrument to its factory default settings.

The Input and Control sub-menus contain further sub-menus with configuration and calibration settings for each process input; control loops 1 & 2 and the digital inputs. Only parameters that are applicable to the hardware and options fitted will be displayed.

From the Configuration Menu, press  or  to select the required sub-menu.

Press  to enter the sub-menu.

If required, press  or  to select the next level sub-menu, then press  to enter.





Hold down  and press  to return to next higher menu level.













Scrolling "Help Text" is shown at the bottom of the screens to aid navigation.



🔑 CONFIGURATION MENU SCREENS:



Configuration Mode Unlocking	Enter correct code number to access Configuration Mode. <i>Factory Default value is 10.</i>
Configuration Options	Select the required Configuration Sub-Menu Option from: Inputs; Control; Outputs; Alarm; Communications; Recorder; Clock; Display; Lock Code or Reset To Defaults.



INPUT CONFIGURATION SUB-MENU SCREENS

Input 1 Setup - Sub-menu to setup Input 1. Press  +  to return to Input Menu	
Input Type	w Select from various Thermocouple, RTD and Linear mA, mV or VDC inputs. - <i>see specifications section on page 245, for available input types.</i>
Engineering Units	w Select display units from: °C; °F; °K; bar; %; %RH; pH; psi or none. <i>Temperature sensor inputs are limited to °C; °F</i>
Decimal Point Position	w Sets the maximum display resolution to 0; 1; 2 or 3 decimal places. Numbers >99.999 never display more than 2 dec places, >999.99 never display more than 1 dec place and >99999 always display without a decimal place. <i>Temperature inputs are limited to 0 or 1 decimal place.</i>
Scaled Input Lower Limit	For temperature inputs, upper & lower limits set the usable span. The minimum span = 100 units, maximum span = range limits for the sensor type selected - <i>see specs on page 245.</i>
Scaled Input Upper Limit	For DC linear inputs, the limits define the values shown (-9999 to 9999.9) when input is at minimum and maximum values. Min span = 100 units.
Multi-Point Scaling Enable	Enables or disables multi-point scaling. This allows up to 15 point input linearization for DC signals - <i>not possible with temperature sensor inputs</i>
Scaling Point <i>n</i>	If multi-point scaling is enabled, up to 15 breakpoints* can scale input vs. displayed values between the scaled input limits. Each breakpoint has a % value for the input signal, and the value to display when the input is at that value. *A Scaling Point set to 100% input ends the scaling sequence.
Display Value <i>n</i>	
CJC Enable/Disable	Enables/disables internal thermocouple Cold Junction Compensation. If disabled, external compensation will be required for thermocouples. The default value is Enabled.
Input Filter Time	Removes unwanted signal noise. Adjustable from 0.1 to 100.0 seconds or OFF (default = 2s). Use the smallest value that gives acceptable results. Caution: Large values slow the response to changes in the process.
Input 1 Calibration - Sub-menu to calibrate Input 1. Press  +  to return to Input Menu	
Calibration Type	Select the calibration type from base; single or 2-point calibration. Select single to apply a calibration offset across the entire measured range. Use 2-point to enter calibration offsets at both low and high points of the usable range – <i>refer to the User Calibration details on page 70.</i> Caution: The default is Base Calibration. For single or 2-point calibration, the user must enter values to adjust the displayed value to match a known standard or accurate external reading.
Calibration Offset	The single point calibration offset. Limited by the input span, +Ve values add to, -Ve values subtract from, the measured input across <u>entire</u> range.
Calibration Low Value	The displayed value for the 1 st (low) adjustment of 2-point calibration. Choose a value close to the lowest level used in the application.
Calibration Low Offset	The adjustment value for the 1 st (low) point when using 2-point calibration. +Ve values add to, -Ve values subtract from measured input at this point.
Calibration High Value	The displayed value for the 2 nd (high) adjustment of 2 point calibration. Choose a value close to the highest level used in the application.
Calibration High Offset	The adjustment value for the 2 nd (high) point when using 2-point calibration. +Ve values add to, -Ve values subtract from measured input at this point.

Input 2 Setup - Sub-menu to setup Input 2. Press  +  to return to Input Menu	
Input 2 Usage	w Input 2 can be used as a standard process input for a second control loop (including its use as part of a cascade), a redundant input or a feedback signal input from a valve or flow meter. Redundant or Feedback disables the input as an independent control loop.
Input Type	w If input 2 is selected as a standard process input, select from various Thermocouple, RTD and Linear mA, mV or VDC inputs. - see specifications section on page 245, for available input types. If input 2 is selected as feedback possible types are limited to Linear mA, mV, VDC or Potentiometer. Redundant inputs automatically assume the same input type as input 1.
	 Note: Recheck the units and decimal point settings if you change the input type.
Engineering Units	w Select display units from: °C; °F; °K; bar; %; %RH; pH; psi or none. <i>Temperature sensor inputs are limited to °C; °F</i>
Decimal Point Position	w Sets the maximum display resolution to 0; 1; 2 or 3 decimal places. Numbers >99.999 never display more than 2 dec places, >999.99 never display more than 1 dec place and >99999 always display without a decimal place. <i>Temperature inputs are limited to 0 or 1 decimal place.</i>
Scaled Input Lower Limit	For temperature inputs, upper & lower limits set the usable span. The minimum span = 100 units, maximum span = range limits for the sensor type selected - see specs on page 245. For DC linear inputs, the limits define the values shown (-9999 to 9999.9) when input is at minimum and maximum values. Min span = 100 units.
Scaled Input Upper Limit	
Multi-Point Scaling Enable	Enables or disables multi-point scaling. This allows up to 15 point input linearization for DC signals - <i>not possible with temperature sensor inputs</i>
Scaling Point n	If multi-point scaling is enabled, up to 15 breakpoints* can scale input vs. displayed values between the scaled input limits. Each breakpoint has a % value for the input signal, and the value to display when the input is at that value. *A Scaling Point set to 100% input ends the scaling sequence.
Display Value n	
CJC Enable/Disable	Enables/disables internal thermocouple Cold Junction Compensation. If disabled, external compensation will be required for thermocouples. The default value is Enabled.
Input Filter Time	Removes unwanted signal noise. Adjustable from 0.1 to 100.0 seconds or OFF (default = 2s). Use the smallest value that gives acceptable results. Caution: Large values slow the response to changes in the process.
Set Valve Lower Position	If input 2 is selected as feedback indication, this stores the feedback value equal to the minimum valve travel. The procedure below moves the valve to the fully closed position to find the feedback value: Press  and  simultaneously to begin feedback limit adjustment. Press  until the valve is closed to its limit of its travel. Press  and  simultaneously to store the feedback level.
Set Valve Upper Position	If input 2 is selected as feedback indication, this stores the feedback value equal to the maximum valve travel. The procedure below moves the valve to the fully open position to find the feedback value: Press  and  simultaneously to begin feedback limit adjustment. Press  until the valve is opened to its limit of its travel. Press  and  simultaneously to store the feedback level.

Input 2 Calibration - Sub-menu to calibrate Input 2. Press  +  to return to Input Menu	
Calibration Type	If input 2 is selected as a standard process input, the user can select the calibration type from base; single or 2-point calibration. Select single to apply a calibration offset across the entire measured range. Use 2-point to enter calibration offsets at both low and high points of the usable range – refer to the User Calibration details on page 70. Caution: The default is Base Calibration. For single or 2-point calibration, the user must enter values to adjust the displayed value to match a known standard or accurate external reading.
Calibration Offset	The single point calibration offset. Limited by the input span, +Ve values add to, –Ve values subtract from measured input across the range.
Calibration Low Value	The displayed value for the 1 st (low) adjustment of 2-point calibration. Choose a value close to the lowest level used in the application.
Calibration Low Offset	The adjustment value for the 1 st (low) point when using 2-point calibration. +Ve values add to, –Ve values subtract from measured input at this point.
Calibration High Value	The displayed value for the 2 nd (high) adjustment of 2 point calibration. Choose a value close to the highest level used in the application.
Calibration High Offset	The adjustment value for the 2 nd (high) point when using 2-point calibration. +Ve values add to, –Ve values subtract from measured input at this point.

Calibration Reminder - Calibration reminder Sub-menu. Press  +  to return to Input Menu	
Calibration Reminder Enable/Disable	Enables/disables the Calibration Reminder shown at start-up (and daily thereafter), if the due date has passed - Recorder version only
Calibration Reminder Date	Sets the due date for Calibration Reminder - Recorder version only

Auxiliary Input A Setup - Sub-menu to setup auxiliary A input. Press  +  to return to Input Menu	
Auxiliary Input A Type	The analogue input type/range to be applied to auxiliary input A. Select the type from 0-20 or 4-20mA; 0-5, 1-5, 0-10 or 2-10VDC.
Aux A Input Lower Limit	These scale values relate to when auxiliary input A is at the range minimum & maximum values. They are adjustable between ±0.001 & ±10000. When auxiliary input A provides a remote setpoint, the scaled input becomes the effective setpoint (although always constrained within setpoint limits). Caution: Take care to scale correctly especially if being used as the remote setpoint source for both loops.
Aux A Input Upper Limit	
Auxiliary Input A Offset	An offset applied to the scaled auxiliary input A value. Adjustable, from +/- 0.001 to 20000 units or OFF, with. +Ve values add, –Ve values subtracted. Useful in multi-zone setpoint slave applications. Default = OFF.



Digital Input Setup - Sub-menu to setup the Digital Inputs. Press + to return to Input Menu																									
Digital Input Status	A diagnostic status (<input type="checkbox"/> = OFF, <input checked="" type="checkbox"/> = ON, \emptyset = not available) for digital inputs A; C1 to C8 and "Soft" digital inputs S1 to S4. If used for profile selection, it also shows bit pattern type (binary or BCD) and selected profile number.																								
Tick Digital Inputs To Invert	Select digitals input with <input checked="" type="checkbox"/> to invert their operation (making them appear OFF when their actual state is ON). Inputs shown as \emptyset are not available.																								
Profile Selection Type	Select the bit pattern to be used for profile selection. Binary or BCD (<i>Binary Coded Decimal</i>). Select None if profile selection not is required.																								
Choose Profile Selection	For profiler versions, the Multi-Digital Input option can be used to select the profile to run with a standard binary bit pattern or binary coded decimal from BCD switches. C1 is the least significant bit (LSB) of the bit pattern. Profiles are numbered from 0 to 63. Use the table to choose inputs C1 to Cn for the number of profiles to select:																								
	<table border="1"> <thead> <tr> <th></th> <th>C1</th> <th>C1 to C2</th> <th>C1 to C3</th> <th>C1 to C4</th> <th>C1 to C5</th> <th>C1 to C6</th> <th>C1 to C7</th> </tr> </thead> <tbody> <tr> <td>Binary</td> <td>0 to 1</td> <td>0 to 3</td> <td>0 to 7</td> <td>0 to 15</td> <td>0 to 31</td> <td>0 to 63</td> <td></td> </tr> <tr> <td>BCD</td> <td>0 to 1</td> <td>0 to 3</td> <td>0 to 7</td> <td>0 to 9</td> <td>0 to 19</td> <td>0 to 39</td> <td>0 to 63</td> </tr> </tbody> </table>		C1	C1 to C2	C1 to C3	C1 to C4	C1 to C5	C1 to C6	C1 to C7	Binary	0 to 1	0 to 3	0 to 7	0 to 15	0 to 31	0 to 63		BCD	0 to 1	0 to 3	0 to 7	0 to 9	0 to 19	0 to 39	0 to 63
		C1	C1 to C2	C1 to C3	C1 to C4	C1 to C5	C1 to C6	C1 to C7																	
Binary	0 to 1	0 to 3	0 to 7	0 to 15	0 to 31	0 to 63																			
BCD	0 to 1	0 to 3	0 to 7	0 to 9	0 to 19	0 to 39	0 to 63																		
Any inputs chosen for profile selection are not available for other uses. – refer to the <i>Digital Inputs</i> on page 75.																									
Configure Digital Inputs	Select any available digital input or soft digital input to be configured for use. The current status of each is shown as Assigned or Unused.																								
Soft Digital Input n Digital Input Logic	Set up a "Soft" digital input n that is the result of the Boolean AND selections of physical inputs, globally OR'd with the OR selections. Press or to select <input checked="" type="checkbox"/> / deselect <input type="checkbox"/> the options. Inputs shown as \emptyset are not available – refer to the <i>Digital Inputs</i> on page 75.																								
Soft Digital Input n Alarm-Event	Further set up of "Soft" digital input n that adds the Boolean OR of Alarms & Events to the physical digital inputs already selected. Press or to select <input checked="" type="checkbox"/> / deselect <input type="checkbox"/> the options. Inputs shown as \emptyset are not available – refer to the <i>Digital Inputs</i> on page 75.																								
Digital Input n Function	Select the function to be operated from digital input n. – The possible functions are: Loop 1 or 2 Setpoint Select; Loop 1 or 2 Auto/Manual Select; Loop 1 or 2 Control Select; Loop 1 or 2 Pre-Tune Select; Loop 1 or 2 Self-Tune Select Clear All Latched Outputs; Output n Clear Latch; Output n Forcing On or Off; Profile Run/Hold; Profile Hold Segment Release; Profile Abort; Data Recorder Trigger or Key n Mimic (replicating pressing or).																								

CONTROL CONFIGURATION SUB-MENU SCREENS	
Control Loop 1 - Sub-menu to setup Control Loop 1. Press + to return to Input Menu These settings apply to the master loop if the controller has been setup for cascade control.	
Control Mode	Select the fundamental application type, from: Standard; Cascade or Ratio. <i>Refer to the Application Setup section on page 33.</i>
	Note: <i>Choosing Cascade or Ratio disables the use of the 2nd input as a fully independent control loop.</i>
Cascade Mode	Opens or closes the cascade link. Cascade-Open breaks the master-slave connection. This allows slave loop to be tuned & adjusted independently. Caution: Return to Cascade when finished!
Control Select	Select from Control Standard or Control VMD (TPSC). Use Control VMD to directly drive the windings of a motorised valve. This uses a 3-point stepping algorithm giving “open” and “close” outputs. Use Standard for all other applications (including solenoid valves or modulating valves with positioning circuitry requiring mA or VDC signals).
Control Enable/Disable	Used to temporarily disable the control outputs. Select control Enabled (normal) or Disabled – when disabled, control output(s) for this loop are turned off (unless manual mode has been selected), and the setpoint value is replaced by “OFF”. Caution: The instrument is not able to control the process when control is disabled and the Output Power Limits are ignored.
Auto/Manual Control Selection	Switches the control loop between Automatic and Manual Control. The operator monitors and alters power to correctly control the process (0 to 100% or -100 to +100% for dual control). Caution: Manual mode overrides the automatic control loop. It also ignores any output power limits, valve open/close limits and the control enable/disable setting. The operator is responsible for maintaining the process within safe limits.
Control Type	Select Single Control for primary control only (e.g. heating only <u>or</u> cooling only) or Dual for primary and secondary control outputs (e.g. heating <u>and</u> cooling) - <i>Dual is not possible with Ratio or VMD Control.</i>
Primary Control Action	Set the primary control output for Reverse or Direct Action. Reverse action applies additional primary power as the process falls further below setpoint (e.g. heating applications). Direct action applies additional primary power as the process rises higher above setpoint (e.g. cooling applications). In dual control, secondary output action is opposite to primary action.
Control Status	A “read-only” diagnostic status display of the current loop 1 process variable and effective setpoint values to assist with manual tuning.
Power Output Levels	A “read-only” diagnostic status display of the current loop 1 primary and secondary % output power levels to assist with manual tuning – <i>Not shown with VMD Control. Does not apply if control is disabled or in manual mode.</i>
Gain Schedule PID Set in use	A “read-only” diagnostic status display showing the PID set in use. The set used may vary based on the current setpoint or process variable value. – <i>Only shown if Gain Scheduling is in use.</i>
PID Set Selection	Choose to use one of five PID Sets; or choose Gain Schedule on SP or PV. – <i>This selects a fixed PID set to be “Active”; or automatically switch sets based changes in SP or PV values.</i>
Set <i>n</i> – Primary Pb	The primary proportional band for PID Set <i>n</i> (<i>n</i> = up to 5). Set as On-Off control, or a proportional band from 1 to 9999 display units – <i>Only the set(s) in use are shown.</i>
Set <i>n</i> – Secondary Pb	The secondary proportional band for PID Set <i>n</i> (<i>n</i> = up to 5) if dual control is used. Set as On-Off control, or a proportional band from 1 to 9999 display units – <i>Only the set(s) in use are shown.</i>

Set <i>n</i> – Integral	The integral time value (Automatic Reset) for PID Set <i>n</i> (<i>n</i> = up to 5). Adjustable from 1s to 99min 59s or OFF – <i>Only the set(s) in use shown.</i>
Set <i>n</i> – Derivative	The derivative time value (Rate) for PID Set <i>n</i> (<i>n</i> = up to 5). Adjustable from 1s to 99 min 59s or OFF – <i>Only the set(s) in use are shown.</i>
Set <i>n</i> – Overlap	The overlap (+ve) or deadband (-ve) between primary & secondary proportional bands for PID Set <i>n</i> (<i>n</i> = up to 5). In display units - <i>limited to 20% of the combined primary & secondary prop band width.</i>
Set <i>n</i> – On/Off Diff	The on-off control hysteresis (deadband) for PID Set <i>n</i> (<i>n</i> = up to 5). Adjustable from 1 to 300 display units, centred about the setpoint – <i>Only the set(s) in use are shown.</i>
Set <i>n</i> - Breakpoint	The SP or PV value where the PID Set <i>n</i> (<i>n</i> = up to 5) if gain scheduling is used. Set 1 is used from Scaled Input Lower Limit to the Set 2 Breakpoint, then Set 2 used to the Set 3 Breakpoint etc. If a breakpoint is set to OFF subsequent PID sets are not used. The final PID set runs to the Scaled Input Upper Limit.
Manual Reset (Bias)	The Manual Reset value to bias the control working point within the proportional band(s). Adjustable from 0 to 100% for single control or 100 to +100% for dual control. Typically set to 80% of typical power needed for setpoint, but lower values can help inhibit start-up overshoot.
Anti Wind-Up Limit	Adjusts the value at which the “reset wind-up inhibit” is applied. Above this power level further integral action is suspended. Adjustable from 10 to 100% of PID power. Lower values inhibit overshoot. Caution: If set too low control deviation can occur (the process settles, but is offset above or below the setpoint). If this is observed, increase the value until the deviation error is removed.
Ratio SFAC	The nominal ratio scaling factor used for Stoichiometric Ratio Control in burner fuel/air control applications. Adjustable from 0.010 to 99.999. – <i>refer to the Ratio Control section on page 81</i> Error! Bookmark not defined.
Ratio NO	A constant between 0.0 & 9999.0, added to the x1 (input 1) value in Stoichiometric Ratio Control mode to allow for atomizing air when calculating the process value. The total air flow is therefore x1 + NO.
Primary Cycle Time	The primary power cycle time. Adjustable from 0.5 to 512 seconds. Applied for time proportioned primary relay, SSR driver or triac control outputs – <i>Not used for VMD Control modes.</i>
Secondary Cycle Time	The secondary power cycle time when dual control is used. Adjustable from 0.5 to 512 seconds. Applied for time proportioned primary relay, SSR driver or triac control outputs – <i>Not used for VMD Control modes.</i>
Primary Power Lower Limit	The minimum primary output power limit. The control algorithm will not allow the power output fall below this level. Adjustable from 0 to 90% but is always at least 10% below the primary power upper limit. Caution: The instrument will not be able to control the process correctly if the lower limit is above the level required to maintain setpoint.
Primary Power Upper Limit	The maximum primary output power limit. The control algorithm will not allow the power output rise above this level. Adjustable from 10 to 100% but is always at least 10% above the primary power lower limit. Caution: The instrument will not be able to control the process correctly if the upper limit is below the level required to maintain setpoint.

Secondary Power Lower Limit	<p>The minimum secondary output power limit. The control algorithm will not allow the power output fall below this level. Adjustable from 0 to 90% but is always at least 10% below the secondary power upper limit.</p> <p>Caution: The instrument will not be able to control the process correctly if the lower limit is above the level required to maintain setpoint.</p>
Secondary Power Upper Limit	<p>The maximum secondary output power limit. The control algorithm will not allow the power output rise above this level. Adjustable from 10 to 100% but is always at least 10% above the secondary power lower limit.</p> <p>Caution: The instrument will not be able to control the process correctly if the upper limit is below the level required to maintain setpoint.</p>
Sensor Break Pre-set Power Output	<p>Set the power level to be applied if the process input signal or an active remote setpoint input is lost. Adjustable from 0 to 100% for single control or -100 to +100% for dual control. The default value is OFF (0% power). <i>Does not apply if control is disabled or in manual mode.</i></p> <p>Caution: Ensure the value set will maintain safe process conditions.</p>
Motor Travel Time	<p>The motor travel time (valve movement time from fully open to fully closed in mm:ss). Adjustable from 5s to 5 mins - <i>In VMD Control Mode only.</i></p>
Minimum Motor On Time	<p>The minimum drive effort (in seconds) to begin moving the motorised valve in VMD Control Mode. Adjustable from 0.02 to $\frac{1}{10}$ of the Motor Travel Time.</p>
Valve Open Limit	<p>The maximum position the controller will attempt to drive the valve to in VMD Control Mode. Adjustable from the valve close limit+1% to 100.0% (<i>fully open</i>) - <i>Only possible if the 2nd input is used for valve feedback.</i></p>
Valve Close Limit	<p>The minimum position the controller will attempt to drive the valve to in VMD Control Mode. Adjustable from 0.0% (<i>fully closed</i>) to the valve open limit-1% - <i>Only possible if the 2nd input is used for valve feedback.</i></p>
Valve Sensor Break Action	<p>The direction to drive the valve if the process input signal or an active remote setpoint input is lost. The default action is to drive the valve closed. – <i>Applies to VMD Control Mode only. Does not apply if control is disabled or in manual mode.</i></p> <p>Caution: Set to safe values for the process!</p>
Setpoint Lower Limit	<p>The minimum allowable setpoint value. Adjustable within the scaled input limits, but cannot be above the setpoint upper limit. Applies to local, remote and profile setpoints.</p> <p>Caution: Set to safe values for the process. Operators can adjust local setpoints to any value between the limits set.</p>
Setpoint Upper Limit	<p>The maximum allowable setpoint value. Adjustable within the scaled input limits, but cannot be below the setpoint lower limit. Applies to local, remote and profile setpoints.</p> <p>Caution: Set to safe values for the process. Operators can adjust local setpoints to any value between the limits set.</p>
Setpoint Ramp Rate	<p>Setpoint Ramp Rate value, adjustable from 1 to 9999 display units per hour, or OFF. The ramp is applied at power-up (<i>from current PV to SP</i>) and whenever the setpoint value or source is changed. If set to OFF, the setpoint steps immediately to the new setpoint value.</p>
Main Setpoint Source	<p>Select the source of the main setpoint. This can only be a “Local” setpoint set from the keypad, or Not used.</p>
Alternate Setpoint Source	<p>Select the source of the alternate setpoint. This can be a “Local” setpoint, not used, or an analogue remote setpoint (RSP) signal applied to input 2 or auxiliary input A – <i>depending on available hardware.</i></p>
Main Setpoint Value	<p>Sets the current value of the main setpoint between the setpoint upper and lower limits.</p>
Alternate Setpoint Value	<p>Sets the current value of the alternate setpoint between the setpoint upper and lower limits – <i>is read-only if alternate setpoint source is RSP.</i></p>

Select Active Setpoint	Select if the main or alternate setpoint is to be the current “active” setpoint for this loop.
Main Setpoint Offset	An offset that can be added to the main setpoint (+ve values) or subtracted from it (-ve values) when the instrument is a comms slave in a multi-zone application. This changes the effective setpoint used for control. Caution: It should be set to zero if an offset is not required.
Alternate Setpoint Offset	An offset that can be added to the alternate setpoint (+ve values) or subtracted from it (-ve values) when the instrument is a comms slave in a multi-zone application. This changes the effective setpoint used for control. Caution: It should be set to zero if an offset is not required.

Control Loop 2 - Sub-menu to setup Control Loop 1. Press  +  to return to Input Menu These settings apply to the slave loop if the controller has been setup for cascade control.	
Control Select	Select from Control Standard or Control VMD (TPSC). Use Control VMD to directly drive the windings of a motorised valve. This uses a 3-point stepping algorithm giving “open” and “close” outputs. Use Standard for all other applications (including solenoid valves or modulating valves with positioning circuitry requiring mA or VDC signals).
Control Enable/Disable	Used to temporarily disable the control outputs. Select control Enabled (normal) or Disabled – when disabled, control output(s) for this loop are turned off (unless manual mode has been selected) and the setpoint value is replaced by “OFF”. Caution: The instrument is not able to control the process when control is disabled and the Output Power Limits are ignored.
Auto/Manual Control Selection	Switches the control loop between Automatic and Manual Control. Caution: Manual mode overrides the automatic control loop. It also ignores any output power limits, valve open/close limits and the control enable/disable setting. The operator is responsible for maintaining the process within safe limits.
Control Type	Select Single Control for primary control only (e.g. heating only <u>or</u> cooling only) or Dual for primary and secondary control outputs (e.g. heating <u>and</u> cooling) - <i>Dual is not possible with Ratio or VMD Control.</i>
Primary Control Action	Set the primary control output for Reverse or Direct Action. Reverse action applies additional primary power as the process falls further below setpoint (e.g. heating applications). Direct action applies additional primary power as the process rises higher above setpoint (e.g. cooling applications). In dual control, secondary output action is opposite to primary action.
Control Status	A “read-only” diagnostic status display of the current loop 2 process variable and effective setpoint values to assist with manual tuning.
Power Output Levels	A “read-only” diagnostic status display of the current loop 2 primary and secondary % output power levels to assist with manual tuning – <i>Not shown with VMD Control. Does not apply if control is disabled or in manual mode.</i>
Gain Schedule PID Set in use	A “read-only” diagnostic status display showing the PID set in use. The set use may vary based on the current setpoint or process variable value. – <i>Only shown if Gain Scheduling is in use.</i>
PID Set Selection	Choose to use one of five PID Sets; or choose Gain Schedule on SP or PV. – <i>This selects a fixed PID set to be “Active”; or automatically switch sets based changes in SP or PV values.</i>
Set <i>n</i> – Primary Pb	The primary proportional band for PID Set <i>n</i> (<i>n</i> = up to 5). Set as On-Off control, or a proportional band from 1 to 9999 display units – <i>Only the set(s) in use are shown.</i>
Set <i>n</i> – Secondary Pb	The secondary proportional band for PID Set <i>n</i> (<i>n</i> = up to 5) if dual control is used. Set as On-Off control, or a proportional band from 1 to 9999 display units – <i>Only the set(s) in use are shown.</i>

Set n – Integral	The integral time value (Automatic Reset) for PID Set n ($n =$ up to 5). Adjustable from 1s to 99min 59s or OFF – <i>Only the set(s) in use shown.</i>
Set n – Derivative	The derivative time value (Rate) for PID Set n ($n =$ up to 5). Adjustable from 1s to 99 min 59s or OFF – <i>Only the set(s) in use are shown.</i>
Set n – Overlap	The overlap (+ve) or deadband (-ve) between primary & secondary proportional bands for PID Set n ($n =$ up to 5). In display units - <i>limited to 20% of the combined primary & secondary prop band width.</i>
Set n – On/Off Diff	The on-off control hysteresis (deadband) for PID Set n ($n =$ up to 5). Adjustable from 1 to 300 display units, centred about the setpoint – <i>Only the set(s) in use are shown.</i>
Set n - Breakpoint	The SP or PV value where the PID Set n ($n =$ up to 5) if gain scheduling is used. Set 1 is used from Scaled Input Lower Limit to the Set 2 Breakpoint, then Set 2 used to the Set 3 Breakpoint etc. If a breakpoint is set to OFF subsequent PID sets are not used. The final PID set runs to the Scaled Input Upper Limit.
Manual Reset (Bias)	The Manual Reset value to bias the control working point within the proportional band(s). Adjustable from 0 to 100% for single control or 100 to +100% for dual control. Typically set to 80% of typical power needed for setpoint, but lower values can help inhibit start-up overshoot.
Anti Wind-Up Limit	Adjusts the value at which the “reset wind-up inhibit” is applied. Above this power level further integral action is suspended. Adjustable from 10 to 100% of PID power. Lower values inhibit overshoot. Caution: If set too low control deviation can occur (the process settles, but is offset above or below the setpoint). If this is observed, increase the value until the deviation error is removed.
Primary Cycle Time	The primary power cycle time. Adjustable from 0.5 to 512 seconds. Applied for time proportioned primary relay, SSR driver or triac control outputs – <i>Not used for VMD Control modes.</i>
Secondary Cycle Time	The secondary power cycle time when dual control is used. Adjustable from 0.5 to 512 seconds. Applied for time proportioned primary relay, SSR driver or triac control outputs – <i>Not used for VMD Control modes.</i>
Primary Power Lower Limit	The minimum primary output power limit. The control algorithm will not allow the power output fall below this level. Adjustable from 0 to 90% but is always at least 10% below the primary power upper limit. Caution: The instrument will not be able to control the process correctly if the lower limit is above the level required to maintain setpoint.
Primary Power Upper Limit	The maximum primary output power limit. The control algorithm will not allow the power output rise above this level. Adjustable from 10 to 100% but is always at least 10% above the primary power lower limit. Caution: The instrument will not be able to control the process correctly if the upper limit is below the level required to maintain setpoint.
Secondary Power Lower Limit	The minimum secondary output power limit. The control algorithm will not allow the power output fall below this level. Adjustable from 0 to 90% but is always at least 10% below the secondary power upper limit. Caution: The instrument will not be able to control the process correctly if the lower limit is above the level required to maintain setpoint.
Secondary Power Upper Limit	The maximum secondary output power limit. The control algorithm will not allow the power output rise above this level. Adjustable from 10 to 100% but is always at least 10% above the secondary power lower limit. Caution: The instrument will not be able to control the process correctly if the upper limit is below the level required to maintain setpoint.
Sensor Break Pre-set	Set the power level to be applied if the process input signal or an active

Power Output	remote setpoint input is lost. Adjustable from 0 to 100% for single control or -100 to +100% for dual control. The default value is OFF (0% power). <i>Does not apply if control is disabled or in manual mode.</i> Caution: Ensure the value set will maintain safe process conditions.
Motor Travel Time	The motor travel time (valve movement time from fully open to fully closed in mm:ss). Adjustable from 5s to 5 mins - <i>In VMD Control Mode only.</i>
Minimum Motor On Time	The minimum drive effort (in seconds) to begin moving the motorised valve in VMD Control Mode. Adjustable from 0.02 to $\frac{1}{10}$ of the Motor Travel Time.
Slave SP Scale Min	The effective cascade slave setpoint value equating to 0% power demand from the master controller - <i>Limited by the slave input scaling.</i> Caution: Set to safe values for the process!
Slave SP Scale Max	The effective cascade slave setpoint value equating to 100% power demand from the master controller - <i>Limited by the slave input scaling.</i> Caution: Set to safe values for the process!
Valve Sensor Break Action	The direction to drive the valve if the process input signal or an active remote setpoint input is lost. The default action is to drive the valve closed. – <i>Applies to VMD Control Mode only. Does not apply if control is disabled or in manual mode.</i> Caution: Set to safe values for the process!
Setpoint Lower Limit	The minimum allowable setpoint value. Adjustable within the scaled input limits, but cannot be above the setpoint upper limit. Applies to local, remote and profile setpoints. Caution: Set to safe values for the process. Operators can adjust local setpoints to any value between the limits set.
Setpoint Upper Limit	The maximum allowable setpoint value. Adjustable within the scaled input limits, but cannot be below the setpoint lower limit. Applies to local, remote and profile setpoints. Caution: Set to safe values for the process. Operators can adjust local setpoints to any value between the limits set.
Setpoint Ramp Rate	Setpoint Ramp Rate value, adjustable from 1 to 9999 display units per hour, or OFF. The ramp is applied at power-up (<i>from current PV to SP</i>) and whenever the setpoint value or source is changed. If set to OFF, the setpoint steps immediately to the new setpoint value.
Main Setpoint Source	Select the source of the main setpoint. This can only be a “Local” setpoint set from the keypad, or Not used.
Alternate Setpoint Source	Select the source of the alternate setpoint. This can be a “Local” setpoint, not used, or an analogue remote setpoint signal applied to input 2 or auxiliary input A – <i>depending on available hardware.</i>
Main Setpoint Value	Sets the current value of the main setpoint between the setpoint upper and lower limits.
Alternate Setpoint Value	Sets the current value of the alternate setpoint between the setpoint upper and lower limits.
Select Active Setpoint	Select if the main or alternate setpoint is to be the “active” setpoint for this loop.
Main Setpoint Offset	An offset that can be added to the main setpoint (+ve values) or subtracted from it (-ve values) when the instrument is a comms slave in a multi-zone application. This changes the effective setpoint used for control. Caution: It should be set to zero if an offset is not required.
Alternate Setpoint Offset	An offset that can be added to the alternate setpoint (+ve values) or subtracted from it (-ve values) when the instrument is a comms slave in a multi-zone application. This changes the effective setpoint used for control. Caution: It should be set to zero if an offset is not required.

OUTPUTS CONFIGURATION SUB-MENU SCREENS

Output *n* Configuration - Up to 9 outputs listed. Any already used show as "Assigned" but can be changed. If "Digital" is shown, the output is driven directly via a digital input (see input configuration). Relevant screen sequences repeat for outputs fitted. Press + to return to Configuration Menu

Linear Output <i>n</i> Type	w	Set the desired type for any linear outputs fitted. From: 0-5, 0-10, 1-5, 2-10V & 0-20, 4-20mA or 0-10VDC adjustable transmitter PSU.
Adjustable 0-10V Transmitter PSU <i>n</i>	w	Sets the voltage required if linear output <i>n</i> type is 0-10VDC adjustable transmitter PSU.
Output <i>n</i> Usage	w	Sets the use for the output. From: Loop 1 or 2 Primary / Secondary Power; Logical OR or AND of Alarms & Profile Events (direct or reverse acting); Retransmission (of loop 1 or 2 effective setpoint, Input 1 or 2 process values). Choices offered are appropriate for the output type fitted (e.g. only linear outputs can retransmit).
OP<i>n</i> OR Selection	w	When an output usage is set for logical OR of alarms & profile events, this selects the alarms or events to be OR'd. Press or to select <input checked="" type="checkbox"/> or deselect <input type="checkbox"/> Alarms 1 to 7; Events 1 to 5; PR (Profile running); PE (Profile Ended). Direct outputs turn on, & reverse outputs turn off according to the selected logical OR combination.
OP<i>n</i> AND Selection	w	When an output usage is set for logical AND of alarms & profile events, this selects the alarms or events to be AND'd. Press or to select <input checked="" type="checkbox"/> or deselect <input type="checkbox"/> Alarms 1 to 7; Events 1 to 5; PR (Profile running); PE (Profile Ended). Direct outputs turn on, & reverse outputs turn off according to the selected logical AND combination.
Output <i>n</i> Latch Enable	w	If enabled, an output will remain latched ON even if the condition that caused it to be on is no-longer present, and remains latched even if the instrument is powered off-on. The output latch must be reset to turn it off.
Note: An output cannot reset if the condition that caused it to turn on is still present.		
Output <i>n</i> Lower Retransmit Limit	w	The displayed value at which the retransmission output reaches its minimum level (e.g the display value when a 4 to 20mA retransmission output is at 4mA). Adjustable from -9999 to 9999.9. The output is at its minimum below this value. Above this value, it rises linearly in line with the displayed value to reach its maximum at the Upper Retransmit Limit display value.
Output <i>n</i> Upper Retransmit Limit	w	The displayed value at which a retransmission output will be at its maximum level (e.g. the display value when a 4 to 20mA retransmission output is at 20mA). Adjustable from -9999 to 9999.9. The output is at its maximum above this display value. Below this value, it falls linearly in line with the displayed value to reach its minimum at the Lower Retransmit Limit display value.

ALARM CONFIGURATION SUB-MENU SCREENS

Alarm *n* Configuration - 7 alarms listed with any already used shown as "Assigned". Relevant screen sequences repeat for each alarm (*n* = 1 to 7). Press + to return to Configuration Menu



Alarm <i>n</i> Type	w	Sets the function of alarm <i>n</i> from: Unused; Process High; Process Low; PV-SP Deviation; Band; Control Loop; Rate Of Signal Change per minute; Input Signal Break; % of Recorder Memory Used, Control Power High, Control Power Low.
Alarm <i>n</i> Source	w	The signal source of Alarm <i>n</i> from: Input 1, Input 2 & Auxiliary Input A; Control Loop 1; Control Loop 2; Loop 1 Primary or Secondary Power; Loop 2 Primary or Secondary Power – auxiliary input A is only possible if fitted and the alarm type can only be input signal break.

Alarm <i>n</i> Value	w	The Alarm <i>n</i> activation point – The value is limited by the scaled input limits for Process High; Process Low; PV-SP Deviation (+ve above, -ve below setpoint), Band (above or below setpoint) type alarms. Rate of Signal Change is a rate of 0.0 to 99999 (rate in <i>units per minute</i>). Memory used, Control Power High, Control Power Low are 0.0 to 100.0% – <i>not required for Control Loop or Input Signal Break alarm types.</i>
Alarm <i>n</i> Hysteresis		The deadband on the “safe” side of alarm <i>n</i> , through which signal must pass before alarm deactivates - <i>not for Rate of Change, Control Loop, Input Break or Percentage of Memory used alarms.</i>
Alarm <i>n</i> Minimum Duration	w	The minimum time that alarm <i>n</i> must be passed its threshold before activating (deactivation is not affected by this parameter). Adjustable from 0.0 to 9999.0 secs. – <i>not used for signal break, memory or loop alarms.</i> Caution: If the duration is less than the time set, the alarm will not become active.
Alarm <i>n</i> Inhibit	w	If the inhibit is enabled, it prevents the initial alarm activation if the alarm condition is true at power up. Activation only occurs once the alarm condition has passed and then reoccurred.
Control <i>n</i> Loop Alarm Type	w	Sets the loop alarm time source, from: Manual Loop Alarm Time (<i>as set in the loop alarm <i>n</i> time screen</i>) or Automatic (<i>twice the integral time constant setting</i>). If configured, a Loop Alarm activates if no response is seen in loop <i>n</i> after this time following the saturation of its power output. – <i>Only seen if an alarm is set for control loop type.</i>
Control <i>n</i> Loop Alarm Time	w	The time (max 99:59 mm:ss) for loop <i>n</i> to begin responding after PID power output reaches saturation, if a manual loop alarm type is configured.

COMMUNICATIONS CONFIGURATION SUB-MENU SCREENS

No Communications Warning		If Communications Configuration menu is entered without a communications module fitted.
Modbus Parity		The setting for Modbus comms parity bit checking, from: Odd; Even or None. Set the same parity for all devices on the network – <i>Only seen if RS485 or Ethernet communications option is fitted.</i>
Modbus Data Rate		The setting for the Modbus comms data speed. From: 4800; 9600; 19200; 38400; 57600 or 115200 bps. Set the same speed for all devices on the network – <i>Only seen if RS485 or Ethernet communications option is fitted.</i>
Master Mode, or Slave Address		Slave address (1 to 255), or multi-zone Setpoint Master Mode – <i>Only seen if RS485 or Ethernet communications option is fitted, but Master mode is not available over Ethernet.</i>
Target Register In Slave		Target memory register for the setpoint value in attached slave controllers. All slaves must have the same setpoint register address as set here - <i>Appears only if unit is in Master mode.</i>
Master Mode Format		The data format required by the attached setpoint slaves. From: Integer; integer with 1 decimal place or float - <i>Appears only if unit is in Master mode.</i>
Serial Communications Write Enable		Enables/disables writing via RS485 or Ethernet communications. When disabled, parameters can be read, but attempts to change their values over comms are blocked.

DATA RECORDER CONFIGURATION SUB-MENU SCREENS:	
No Recorder Warning	If the Recorder Configuration menu is entered on an instrument without this option fitted.
Recording In Progress Warning	A warning if recording when attempting to enter recorder configuration. - <i>Access to the configuration is denied unless the recording is paused.</i>
Pause (Override Trigger)	Select No to continue recording or Yes to enter recorder configuration. <div style="border: 1px solid blue; padding: 2px; display: inline-block;"> Note: <i>Recording is paused until recorder configuration is completed. It restarts automatically on exit from this menu.</i> </div>
Recorder Status Information	<p>Current information about the data recorder feature, including if a recording is in progress (Recording or Stopped); the recording mode (FIFO or Record Until Memory Is Used); a % memory use bar-graph and the estimated available time remaining based on the data selected and memory left. <i>If the alarm status is recorded and is likely to change often, take this into account when determining if there is sufficient memory available.</i></p> <p>Icons are displayed for active recording triggers. If any trigger is active, the selected data will be recorded.</p> <div style="display: flex; justify-content: space-around; align-items: center; text-align: center;"> <div> Manual Record</div> <div> Digital Input</div> <div> Profile Record</div> <div> Alarm Record</div> </div> <p>- see the Data Recorder in section on page 97</p>
Recorder Mode	Choose Record Until Memory Used (stops recording when full) or Continuous FIFO (First In - First Out). Caution: A FIFO recording will overwrite previous recordings in memory, starting with the oldest data first. Download the previous data before selecting this option.
Recording Sample Interval	Recording of the selected data will happen once every sample interval. From every: 1; 2; 5; 10; 15; 30 Seconds, or 1; 2; 5; 10; 15; 30 Minutes. - <i>The recording interval does not affect Trend View sample rates.</i> <div style="border: 1px solid blue; padding: 2px; display: inline-block;"> Note: <i>Shorter intervals reduce the possible recording duration.</i> </div>
Recorder Auto Trigger	Automatic recording triggers. From: None; On Alarm; During Profile and Alarm or Profile. Data is recorded if <u>any</u> trigger is active (including a digital input or manual recording start).
Trigger On Alarms	Any combination of alarms 1 to 7 can be set to trigger a recording (TRG) or not (OFF). If any alarm set to TRG becomes active, the alarm recording trigger will also activate.
Loop 1 Values To Record	Any combination of loop 1 values can be recorded from: Process Variable; Maximum or Minimum PV (since the previous sample was taken); Setpoint; Primary Power, Secondary Power. Set to Record (REC) or not (OFF). <div style="border: 1px solid blue; padding: 2px; display: inline-block;"> Note: <i>Recording more parameters reduces the possible recording duration.</i> </div>
Loop 2 Values To Record	Any combination of loop 2 values can be recorded from: Process Variable; Maximum or Minimum PV (since the previous sample was taken); Setpoint; Primary Power, Secondary Power. Set to Record (REC) or not (OFF). <div style="border: 1px solid blue; padding: 2px; display: inline-block;"> Note: <i>Recording more parameters reduces the possible recording duration.</i> </div>
Other Values To Record	If required, select to record the value of auxiliary input A.

Activities To Record	Multiple process events can be recorded from: Alarm <i>n</i> Status (<i>n</i> = 1 to 7) or Unit turned Off/On.
	 Note: <i>If an alarm changes state between samples, this will also be recorded using extra memory. The remaining recording time is reduced accordingly.</i>
Profiler Events To Record	The Profiler Event <i>n</i> Status can be recorded (<i>n</i> = 1 to 5).
	 Note: <i>If a profile event changes state between samples, this will also be recorded using extra memory. The remaining recording time is reduced accordingly.</i>

CLOCK CONFIGURATION SUB-MENU SCREENS

Date Format	w	The format used for all displayed dates: <i>dd/mm/yyyy</i> (Day / Month / Year) or <i>mm/dd/yyyy</i> (Month / Day / Year). – Recorder versions only.
Set Date	w	Set the internal clock Date – Entered in the format defined by Date Format screen. – Recorder versions only.
Set Time	w	Set the internal clock Time. - In <i>hh:mm:ss</i> (Hours : Minutes : Seconds) format. – Recorder versions only.

 **Note:** *Clock settings cannot be changed when the data recorder is active.*

DISPLAY CONFIGURATION SUB-MENU SCREENS

Language	Select English or the alternate local language. The alternate language is selected at time of order, but can be changed later using the PC software.
Enable Custom Display Mode	Enables/disables the Custom Operation Mode, if configured. The screens seen in this mode are configured using the PC configuration software.
Read Only Operation Mode?	Allows Operation Mode to be Read/Write or Read-Only where screens can be seen but the values cannot be changed.
Display Colour	From: Red only; Green only; Red to Green on Alarm or Green to Red on Alarm; Red to Green if Output Latched or Green to Red if Output Latched.
Invert Display	Standard or Inverted display image.
Display Contrast	Screen contrast (10 and 100) to improve clarity. 100 = maximum contrast.
Loop 1 Trend Sample Interval	The Interval between the displayed values on the loop 1 trend graph. From: Every 1; 2; 5; 10; 15; 30 Seconds, or 1; 2; 5; 10; 15; 30 Minutes. - <i>Independent from the loop 2 trend graph and data recorder sample rates.</i>
Loop 1 Trend View Mode	The data to display on the loop 1 trend graph. From: Process Value only, PV (solid) & SP (dotted) at sample time, or the Max & Min PV between samples (candle-stick graph). <i>Alarm active indication is always shown at the top of graph.</i>
Loop 2 Trend Sample Interval	The Interval between the displayed values on the loop 2 trend graph. From: Every 1; 2; 5; 10; 15; 30 Seconds, or 1; 2; 5; 10; 15; 30 Minutes. - <i>Independent from the loop 1 trend graph and data recorder sample rates.</i>
Loop 2 Trend View Mode	The data to display on the loop 1 trend graph. From: Process Value only, PV (solid) & SP (dotted) at sample time, or the Max & Min PV between samples (candle-stick graph). <i>Alarm active indication is always shown at the top of graph.</i>
Operator Visibility	Extra parameters can be made visible/adjustable in Operation Mode from: Profile Control; Recorder Start/Stop; Recorder Status; Loop 1 & 2 Setpoint Select; Loop 1 & 2 Auto/Manual Select; Loop 1 & 2 Control Select; Loop 1 & 2 Trend View; Loop 1 & 2 Setpoint Ramp Rate. <i>See ■ in Operator Mode lists.</i>

LOCK CODE CONFIGURATION SUB-MENU SCREEN	
Lock Code Configuration	Set Lock Codes (passwords) for the following configuration and control menus: Setup Wizard; Configuration Mode; Tuning Menu; Supervisor Mode; USB Menu; Recorder Menu, Profiler Setup and Profiler Menu. Independently adjustable from 1-9999 or OFF.
	 Note: <i>The factory default value is 10 for all lock codes. For security, users are recommended to change these codes.</i>

RESET TO DEFAULTS SUB-MENU SCREEN	
Reset To Defaults	The user can set all parameters back to their factory default values before preparing the instrument for installation in a new application. Caution: The user must reconfigure all of the required settings before using the instrument.

The USB Menu

A notification is shown if a USB memory stick is inserted or removed from the USB port. The USB Menu will automatically be offered after insertion. The USB menu can also be accessed from the Main Menu.



Entry into the USB Menu



CAUTION: Do not remove the memory stick from the USB port whilst a Data Transfer to or from the USB stick is in progress. Data loss or corruption may result.

The USB Menu is entered from the Main Menu

Hold down  and press  to enter the Main Menu.



Press  or  to select the USB Menu





Note: *Entry into this mode is security-protected by the USB Menu Lock Code. Refer to the Lock Code Configuration sub-menu.*

Press  to enter the USB Menu.

Navigating in the USB Menu

Press  to move forward, or  to move backwards through the screens.

Press  or  to change the value as required.





The next/previous screen follows the last parameter. If no further changes are required, hold down  or  >1sec to skip straight to next/previous screen accepting **ALL** values shown.

Hold down  and press  to return to the Main Menu



Note: During Data Transfer, normal operation carries on in the background, but operator access to other screens is not possible. The transfer of a full memory can take up to 20 minutes. Only begin a transfer when you are certain that access (e.g. setpoint changes) will not be required.

Scrolling "Help Text" is shown at the bottom of the screens to aid navigation.

🔒 USB MENU SCREENS		
USB Mode Unlocking	Enter correct code number to access the USB Menu. <i>Factory Default value is 10.</i>	
Read/Write To USB Device	Select the required action from: Read Configuration File; Write Configuration File; Write Recorder Log File. Read Profile Files; Write Profile Files.  Note: "Writing" is downloading from the Instrument to the USB stick. "Reading" is uploading from the USB stick to the Instrument.	
Write	Select Profile To Write	If writing a profile to the USB memory stick, choose a profile to write from the list provided.
	Enter A File Name	Enter an 8-character file name if writing configurations or profiles. A file extension is automatically added to the end of file name (bct for configurations or pfl for profiles). Caution: Existing files with the same name will be over-written.
	Enter A Folder Name	Recorder logs can contain multiple files. The user enters an 8-character folder name for these logs. See the Data Recorder section on page 97.  Note: To prevent existing recordings being over-written, an error message is shown if the folder name entered already exists.
	Writing Profile, Configuration or Log	An animated screen is shown the files are being written. Caution: Do not disconnect USB device until completed! Data loss or corruption may result.
	Transfer Successful	Confirmation that the data transfer to the USB stick completed correctly. Press  to continue
Transfer Failure	For write failures, check for adequate disk space on the USB stick.	
Read	Select File	Select the Configuration or Profile file to transfer from the USB stick. Caution: Configuration reads overwrite <u>all</u> of the instruments existing settings with new values.
	Reading Profile or Configuration File	An animated screen is shown while files are being read. Caution: Do not remove the memory stick whilst this operation is in progress. Data corruption may result.
	Transfer Successful	Confirmation that the data transfer from the USB stick completed correctly. Press  to continue.
	Transfer Failure	For read failures, check the maximum number of profiles and/or segments is not being exceeded.



Recorder Control Menu

This menu allows the user to manually start a recording or to delete previous recordings. Refer to the Recorder Configuration sub-menu in Configuration Mode for information about how to setup the data to be recorded and the recording interval and the Data Recorder Option section on page 97 for general information about the recorder feature.

Entry into the Recorder Control Menu

The Recorder Control Menu is entered from the Main Menu

Hold down  and press  to enter the Main Menu.



Press  or  to select the Recorder Control Menu







Note: *Entry into this mode is security-protected by the recorder control menu lock code. Refer to the Lock Code Configuration sub-menu.*



Press  to enter the Recorder Control Menu.

Navigating the Recorder Control Menu

Press  to move forward, or  to move backwards through parameters & screens.

Holding down  or  for more than 1 second skips immediately to the next/previous screen accepting **ALL** values as shown.





Press  or  to select or change the value as required.

The next/previous screen follows the last parameter. If no further changes are required, hold down  or  >1sec to skip straight to next/previous screen accepting **ALL** values shown.

Hold down  and press  to return to the Main Menu

Scrolling “Help Text” is shown at the bottom of the screens to aid navigation.

🔒 RECORDER MENU SCREENS	
Recorder Mode Unlocking	Enter correct code number to access the Data Recorder Menu. <i>Factory Default value is 10.</i>
Recording In Progress Warning	Shown if a recording is in progress when the recorder control menu is entered.
Start/Stop Data Recording	Turn on or off the manual recording trigger.  Note: <i>Recording continues if another record trigger is active (e.g. on alarm/profile or via a digital input). Access is restricted to this screen only until recording stops (remove all active triggers).</i>

Recorder Status Information	<p>Current information about the data recorder feature, including if a recording is in progress (Recording or Stopped); the recording mode (FIFO or Record Until Memory Is Used); a % memory use bar-graph and the estimated available time remaining based on the data selected and memory left. <i>If the alarm status is recorded and is likely to change often, take this into account when determining if there is sufficient memory available.</i> Icons are displayed for active recording triggers. If any are active, the selected data will be recorded.</p> <div style="display: flex; justify-content: space-around; align-items: center;"> <div style="text-align: center;">  Manual Record </div> <div style="text-align: center;">  Digital Input </div> <div style="text-align: center;">  Profile Record </div> <div style="text-align: center;">  Alarm Record </div> </div> <p>- see the Data Recorder in section on page 97</p>
Clear Recordings	<p>Clears the recorder memory. Download any recorded data before use. Caution: This permanently deletes <u>All</u> recorded data.</p>



Profiler Setup Menu

Screens marked ⌚ will not time-out automatically. They must be completed for a valid profile to be created. Refer to the Profiler section on page 87 for more details about the profiler.

Entry into the Profiler Setup Menu

The Profiler Setup Menu is entered from the Main Menu

Hold down  and press  to enter the Main Menu.



Press  or  to select the Profiler Setup Menu







Note: Entry into this mode is security-protected by the profiler setup menu lock code. Refer to the Lock Code Configuration sub-menu.

Press  to enter the Profiler Setup Menu.

Navigating the Profiler Setup Menu

Press  to move forward, or  to move backwards through the screens.



















Press  or  to select or change the value as required.





Holding down  or  for more than 1 second skips immediately to the next/previous screen accepting **ALL** values as shown.

Hold down  and press  to return to the Main Menu



Scrolling “Help Text” is shown at the bottom of the screens to aid navigation.

🔒 PROFILER SETUP MENU SCREENS	
Profiler Setup Menu Unlocking	Enter correct code number to access Profiler Setup Menu. <i>Factory Default value is 10.</i>
Profile Setup Options	Select the required profile setup sub-menu option from: General Configuration; Create a Profile; Edit a Profile Header; Edit a Profile Segment; Insert a Segment; Delete a Segment; Delete a Profile or Delete ALL Profiles.



General Profile Configuration		Sub-menu with global settings affecting all profiles. <i>Press  +  to return to Profile Setup Menu</i>
General	Enable Edit While Running	Enables or disables the ability to edit profiles whilst a profile is running. Caution: Edits made to the <u>current or next segment</u> of the running profile will take effect until after the profile is restarted.
	Timer Start Function	Enable or disable automatic starting of profiles. When enabled, delayed starts are possible, or if the selected profile has a day & time trigger it waits until the time set before starting.  Note: If the Timer Start Function is disabled, profiles can only be manually started, and with <u>immediate effect</u> even if they have a delay or day & time trigger defined.
Create A Profile		 Sub-menu to create a new profile. A header is created first, followed by the segments – see below. Caution: It is not possible to exit from this sub-menu until profile creation is fully complete. Do not turn off the power during profile creation or editing. When the profile creation/editing is complete the instrument returns automatically to the profile setup main menu.  Note: A warning is displayed if the maximum number of 64 profiles or 255 segments is exceeded.
Profile Header Details	Profile Header:	<i>Settings that apply to the chosen profile as a whole.</i>
	Enter Profile Name	 Give each profile a unique descriptive name of up to 16 characters. The name is shown in the profile status screen and in profile selection lists.
	Set the Number of Loops	 Select if a profile controls the setpoint of first loop only or both control loops. This screen is “read only” when editing a profile. The number cannot be changed once the profile has been created.  Note: the segment type and time settings are common to both loops. Some segment types are not available with 2-loop profiling.
	Profile Starting Point	 The setpoint value used at the beginning of the first segment. From: Current Setpoint or Current Process Variable. The setpoint starts from the measured PV(s) or effective setpoint(s) of the process as it begins running.
	Profile Start Trigger	 From: None (profile start is not delayed); After Delay or Day and Time. - Day and Time possible on the recorder version only.  Note: If the Timer Start Function has been disabled, profiles can only be manually started, and with <u>immediate effect</u> even if they have a delay or day & time trigger defined.
	Profile Start Time	 If Day and Time is the Profile Start Trigger, this is the time (hh:mm:ss) when the profile will begin if it is selected to run.
	Profile Start Day(s)	 If Day and Time is the Profile Start Trigger, this is the Day(s) when the profile should run. From: Mon; Tue; Wed; Thu; Fri; Sat; Sun; Mon-Fri; Mon-Sat; Sat-Sun or All.
	Profile Start Delay Time	 If After Delay is the Profile Start Trigger, this is the delay time of up to 99:59 (hh:mm) before a profile begins after a start request has been given.
	Profile Recovery Method	 The power-on action if profile was running at power-down (e.g. after a power cut), or following correction of a signal break. From: Control outputs off; Restart profile from the beginning; Maintain last profile setpoint; Use controller setpoint; Continue profile from where it was when power failed.
	Profile Recovery Time	 The Recovery Method is ignored (the profile continues from where power failed), if power off for less than this time. Max 99:59 (hh:mm). - Recorder version only.
	Profile Abort Action	 The action taken after profile has been forced to stop early. From: Control outputs off; Maintain last profile setpoint or Use controller setpoint.
Profile Cycles	 The number of times the program should run each time it is started. From 1 to 9999 or Infinite.	

Profile Segments: <i>Settings that apply to individual profile segments</i>	
Segment Number	⌚ Shows the number of the profile segment being created. The maximum number of profiles across all profiles is 255.
Segment Type	⌚ Set the segment type from: Ramp Time (time to reach target SP); Ramp Rate (rate of change towards target SP – <i>Single loop profiles only</i>); Step (jump to target SP), Dwell (keep current SP); Hold (hold profile until released); Loop (back to previous segment); Join (to another profile); End or Repeat Sequence Then End (repeat a sequence of joined profiles).  Note: <i>Segment Ramp Rate is not available if the profile controls two loops. A Join, End or Repeat Sequence Then End is the last segment in the profile. Repeat Sequence Then End is always the last profile in a sequence.</i>
Loop 1 Target Setpoint.	⌚ The setpoint value to be reached control loop 1 by the end of this segment, if the type is Ramp Time, Ramp Rate or Step.
Loop 2 Target Setpoint.	⌚ If the profile is controlling 2 loops, this is the setpoint value to be reached control loop 2 by the end of the segment, if the type is Ramp Time or Step.
Segment Ramp Time	⌚ The time (hh:mm:ss) to reach the segment target setpoint if the segment type is Ramp Time.
Segment Ramp Rate	⌚ The rate of change towards the Segment Target Setpoint if segment type is Ramp Rate. The rate can be from 0.001 to 9999.9 display units per hour.
Segment Dwell Time	⌚ The time (hh:mm:ss) to maintain the current setpoint if the segment type is Dwell.
Number of Loops	⌚ If the segment type is Loop, enter the number of times to repeat the loop back, before continuing forward to the next segment.
Back to Segment Number	⌚ If the segment type is Loop, enter the segment to loop back to.  Note: <i>Two Loop-backs cannot be set to cross each other.</i>
Loop 1 Auto-Hold Type	⌚ The auto-hold type for this segment to ensure loop 1 tracks the setpoint. From: None (no auto-hold); Above Setpoint (hold if too high only); Below Setpoint (hold if too low only) or Band (hold if too high or low).
Loop 1 Auto-Hold Band Value	⌚ The distance loop 1 can be from setpoint. Beyond this the profile is held for the selected Auto-Hold Type.  Note: <i>For Two-Loop Profiles, either loop can cause the profile to hold. The profile continues only when both loops are within their Auto-Hold Bands.</i>
Loop 2 Auto-Hold Type	⌚ The auto-hold type for this segment to ensure loop 2 tracks the setpoint. From: None (no auto-hold); Above Setpoint (hold if too high only); Below Setpoint (hold if too low only) or Band (hold if too high or low).
Loop 2 Auto-Hold Band Value	⌚ The distance loop 2 can be from setpoint. Beyond this the profile is held for the selected Auto-Hold Type.  Note: <i>For Two-Loop Profiles, either loop can cause the profile to hold. The profile continues only when both loops are within their Auto-Hold Bands.</i>
Segment Hold Release Type	⌚ A hold segment can either be released by an Operator/Digital input or be set to wait until a specified Time of Day - <i>Recorder version only</i> .
Hold Release Time	⌚ The time of day (hh:mm:ss) when a Hold Segment will release if the Release Type is Time Of Day. The profile is held by the hold segment and only released at the next occurrence of the time of day set.
Times To Repeat Sequence	⌚ The number of times the entire sequence of profiles should run. – if the last segment is Repeat Sequence Then End.
Segment End Type	⌚ The action taken after the profile ends normally. From: Control Outputs Off; Maintain Last Profile Setpoint or Use Controller Setpoint.
Select Profile To Join	⌚ Choose a profile to join to from the list provided – if the final segment type is Join. The selected profile will start immediately the current profile ends.

Profile Segment Details

Event <i>n</i>	⌚ Select the events to be active during this segment. <i>n</i> = 1 to 5. Note: For end segments, the events selected to be active stay on until the instrument exits from profiler mode or a new profile runs.
	 Note: For end segments, the events selected to be active stay on until the instrument exits from profiler mode or a new profile runs.
Edit A Profile Header	⌚ Choose the profile to be edited from the list of names provided, then alter any values as required – <i>The profile header details are as shown in “Create A Profile” above.</i>
Edit A Profile Segment	⌚ Choose the profile, then the segment to be edited from the lists provided. Alter any values as required – <i>The profile segment details are as shown in “Create A Profile” above.</i>
	 Note: The last segment type can only be set to Join, End or Repeat Sequence Then End. Use Insert or Delete to change the end position.
Insert A Segment	⌚ Choose the profile, then the new segment’s position from the lists provided – Enter the new segment values as required – <i>The profile segment details are as shown in “Create A Profile” above.</i>
	 Note: The new segment type cannot be set to Join, End or Repeat Sequence Then End. Use Delete to change the end position.
Delete A Segment	⌚ Choose the profile, then the segment to be deleted from the lists provided. End, Join or Repeat segments cannot be deleted.
Delete A Profile	⌚ Choose the profile to be deleted from the list of names is provided. The user is prompted confirm the deletion.
Delete All Profiles	⌚ If selected, the user is prompted to confirm that the profiles should be deleted. Caution: This deletes all profiles from memory!

Profiler Control Menu

 PROFILER CONTROL MENU SCREENS	
Profiler Control Menu Unlocking	Enter correct code number to access Profiler Control Menu. <i>Factory Default value is 10.</i>
Profile Control	If a profile is running, from: Do Nothing; Abort Profile (end immediately); or Jump to Next Profile Segment; Hold Profile or Release Hold. If profile not running, from: Do Nothing; Run Profile; End Profile Control (return to normal controller operation) or Select Profile.
Select Profile	Selects a profile. If Run Profile was chosen in the previous screen, the profile starts (after a delay if one is enabled). Otherwise the profile is selected, but waits for a run instruction (e.g. via digital input or timer).
	 Note: Selection is “read only” if profile selection is via a digital input. Otherwise choose from the list of profile names provided.

Service & Product Information Mode

This is read only information about the instrument, its modules and enabled features. It has contact information to tell the user where they can obtain service, sales or technical support for the product. Normally this is the manufacturer or suppliers' details. Using the PC software, the user can enter their own contact information. There are 7 lines of text - each up to 25 characters in length.

Entry into Service & Product Information Mode



The Service & Product Information Mode is entered from the Main Menu

Hold down  and press  to enter the Main Menu.

Press  or  to select the Service & Product Information Mode

Press  to enter the Service & Product Information Mode.

Navigating Product Information Mode

Press  to move forward or  to move backwards through the displayed information.

Hold down  and press  to return to the Main Menu

Scrolling "Help Text" is shown at the bottom of the screens to aid navigation.

SERVICE & PRODUCT INFORMATION SCREENS:	
Plug-in Module Information	Lists the type plug-in modules types in Slots 1, 2, 3 or A – see page 4 for a full list of field upgradeable plug-in options.
Base Options	Lists factory fitted base options, from: 2nd Universal/Aux input; Output 4 & 5 Relay; Output 6 & 7 Linear mA/V DC.
Optional Features	Lists which other optional features are fitted/enabled, from: Profiler; USB Port; Data Recorder and 8 Digital Inputs.
Firmware Information	The type and version of firmware installed in the instrument.
Product Revision Level	Software and Hardware update status.
Serial Number	The instrument serial number.
Date of Manufacture	The instrument Date of Manufacture (date format is dd/mm/yyyy).
Input 1 Calibration Status	The base calibration status for each signal type on input 1. Caution: Re-calibrate input 1 for mVDC, VDC, mADC, RTD or Thermocouple CJC if they do not say "Calibrated" – see page 72
Input 2 Calibration Status	The base calibration status for each signal type on optional input 2. Caution: Re-calibrate input 2 for mVDC, VDC, mADC, RTD or Thermocouple CJC if they do not say "Calibrated" – see page 72
Calibration Check Due Date	The date re-calibration is due. – only shown if the Calibration Reminder is enabled in the Input Configuration menu.
For Service Contact	Contact information for service, sales or technical support.

Automatic Tuning Menu

The automatic tune menu is used to engage pre-tune and/or self-tune to assist setting up proportional bands and the integral and derivative time values used by the control loops.



Pre-tune can be used to set PID parameters approximately. Self-tune may then be used to optimise the tuning if required. See the Tuning section on page 99 for more information.

Pre-tune can be set to run automatically after every power-up by enabling Auto Pre-Tune.

Entry into the Automatic Tuning Menu

The Automatic Tuning Menu is entered from the Main Menu

Hold down  and press  to enter the Main Menu.

Press  or  to select the Automatic Tuning Menu.

Press  to enter the Automatic Tuning Menu.



Navigating the Automatic Tuning Menu



Press  to move forward or  to move backwards through the selections.

Press  or  to change values or engage and disengage the tuning as required.

Hold down  and press  to return to the Main Menu

Scrolling "Help Text" is shown at the bottom of the screens to aid navigation.

🔒 AUTOMATIC TUNING MENU SCREENS	
Automatic Tuning Mode Unlocking	Enter correct code number to access the Automatic Tuning Menu. <i>Factory Default value is 10.</i>
Control loop 1 or 2	Select which control loop you want to tune – <i>if unit has 2 control loops.</i>
Cascade Mode	To pre-tune a cascade slave, select open-cascade.
	 Note: <i>When slave tuning is completed, repeat choosing open-cascade to tune the master.</i>
Pre-Tune Method	From: Pre-Tune Standard or Pre-Tune at Value. Standard Pre-Tune tests the process response half-way from the activation point to the setpoint. Pre-Tune at Valve allows the user to specify where the test occurs.
Pre-Tune Value	Sets the value at which the process is tested for Pre-Tune at Valve. Caution: Consider possible over-shoot!
Pre-Tune Save Location	Store the pre-tune result to one of 5 PID sets. The new PID terms can be stored to any set, <u>without changing</u> the "active set" from control configuration.
Run Pre-Tune on Set n Now?	w Turns pre-tune on/off for the <u>chosen</u> PID Set. If configured, the TUNE LED indicator flashes whilst pre-tune is operating - <i>*see below.</i>
	 Note: <i>Pre-tune is disabled in on-off control mode; if the PV is less than 5% of span from setpoint; during Profiles; if the setpoint is ramping or if the selected control loop has been disabled.</i>
Pre-Tune Status	Shows the current pre-tune status: Running or Stopped. If an attempt to run pre-tune failed, the reason is shown.

Engage Self-Tune	Turns self-tune on/off for the <u>active</u> PID Set. If configured, the TUNE LED indicator is continuously on whilst self-tune is operating - *see below.
	 Note: Self-Tune disabled if control is On-Off or disabled. If engaged during setpoint ramping, profile ramps or pre-tuning it is suspended until the ramp or pre-tune is completed.
Self-Tune Status	Shows current self-tune status: Running or Stopped. If an attempt to run self-tune failed, the reason is shown.
Auto Pre-Tune At Power Up	Enables/disables automatic pre-tune. When enabled, this attempts to tune the <u>active</u> PID set at every power-up (see Run Pre-Tune Now above).
	 Note: Auto Pre-tune applies standard pre-tune engagement rules at power-up. It is disabled in on-off control mode; if the PV is less than 5% of span from setpoint; during Profiles; if the setpoint is ramping or if the selected control loop has been disabled.

* **TUNE** indication is the default function of LED 3 but the user may have altered the LED functions or the labels using the PC Configuration Software. If LED 3 is used as a **TUNE** indicator, it flashes while pre-tune is operating, and is continuously on whilst self-tune is operating. If both pre-tune and self-tune are engaged the **TUNE** indicator will flash until pre-tune is finished, and is then continuously on.



Note: Pre-tune will flash the LED instead of turning it on, but flashing will be obscured if the LED had been configured to be used in conjunction with other functions and one of these is on.



Lost Lock Codes



All menu lock codes can be viewed or changed from configuration mode – see page 60. In the event that the configuration mode lock code is forgotten, the instrument can be forced into Lock Code Configuration from power-up, where the codes can be checked or set to new values.

Forcing Lock Code Configuration

Power down the instrument.

Re-apply the power and hold down  and  for more than 5 seconds as the start-up splash screen appears. The Lock Code Configuration menu is displayed.

Press  to move forward or  to move backwards through the screen elements.

Make note of the codes or press  or  to change their values if required.

Hold down  and press  to return to the Main Menu

Scrolling “Help Text” is shown at the bottom of the screens to aid navigation.

9 Input Calibration & Multi-point Scaling

User Calibration

The process inputs can be adjusted to remove sensor errors or to match the characteristics of the attached process. For each loop, independent use of base (unadjusted), single point offset or two point calibration strategies are possible, as is the use of multi-point scaling for the displayed values of linear inputs. These parameters are in the Input 1 & 2 calibration sub-menus of [Input Configuration Sub-Menu Screens](#) - page 46.



CAUTION: Incorrect use of Calibration & Scaling can make the displayed value very different from the actual process variable. There is no front panel indication of when these parameters are in use.



Note: These methods do not alter the internal instrument calibration. Simply choose Base Calibration to restore normal measured values. Re-calibration of the internal base values is possible, but should only be attempted by qualified personnel as it overwrites the factory calibration – see [Base Calibration Adjustment](#) below if you think this may be required.

Calibration Reminder

If the Data Recorder feature is fitted, a calibration reminder can be set for a future date. From this date a daily reminder is shown (*and shown at every start-up*), until a new date has been set. This is useful in applications that require a regular check of the measured accuracy – see [Input Configuration Sub-Menu Screens](#) on page 46.

Single Point Calibration

This is a 'zero offset' applied to the process variable across the entire span. Positive values are added to the reading, negative values are subtracted. It can be used if the error is constant across the range, or the user is only interested in a single critical value.

To use, select Single Point Calibration from the input calibration menu, and simply enter a value equal, but opposite to the observed error to correct the reading.

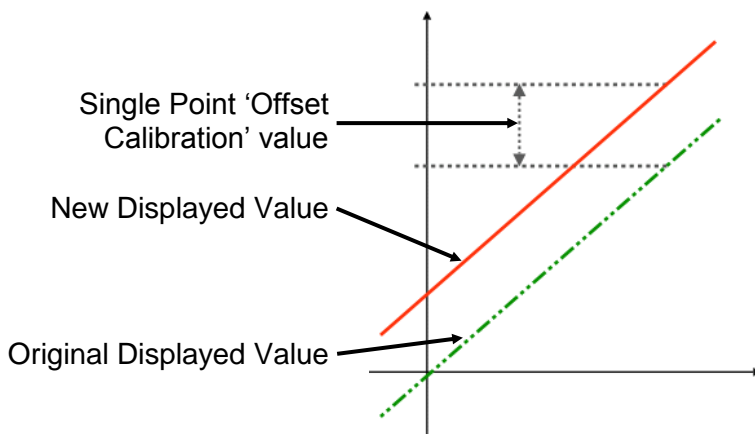

This example shows a positive offset value. For example:

If the process displays 27.8 when it should read 30, The error is -2.2 so an applied offset of +2.2 would change the displayed value to 30.

The same offset is applied to all values, so at 100.0 the new displayed value would be 102.2.

Figure 44. Single Point Calibration

Two Point Calibration

This method is used where an error is not constant across the range.

Separate offsets are applied at two points in the range to eliminate both “zero” and “span” errors. To use:

1. Measure and record the error at a low point in the process.
2. Measure and record the error at a high point in the process.
3. Go to the first two point input calibration screen.
 - a. Enter the desired low point value as the Calibration Low PV value.
 - b. Enter an equal, but opposite value to the observed error as the Calibration Low Offset to correct the error at the low point.
4. Go to the second two point input calibration screen.
 - a. Enter the desired high point as the Calibration High PV value.
 - b. Enter an equal, but opposite value to the observed error as the Calibration High Offset to correct the error at the high point.

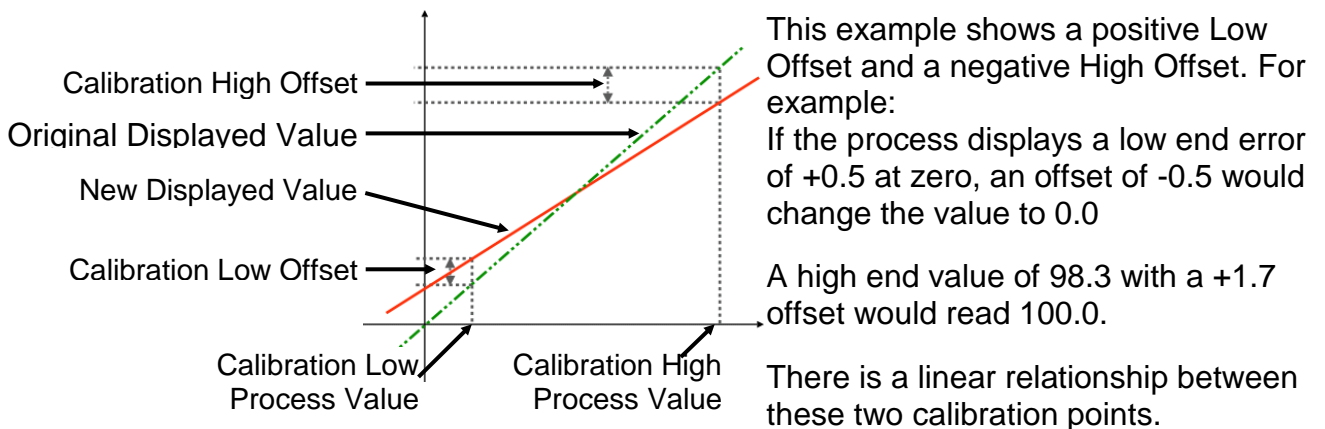

Figure 45. Two Point Calibration



CAUTION: Choose values as near as possible to the bottom and top of your usable span to achieve maximum calibration accuracy. The effect of any error can grow at values beyond the chosen calibration points.

Multi-point Scaling

If an input is connected to a linear input signal (mA, mV or VDC), multi-point scaling can be enabled. This allows the linearization of a non-linear signal. – see *Input Configuration Sub-Menu Screens on page 46*.

The Scale Input Upper & Lower Limits define the values shown when the input is at its minimum and maximum values. Up to 15 breakpoints can scale the input vs. displayed value between these limits. It is advisable to concentrate the break points in the area of the range with the most non-linearity, or an area of particular importance to the application.

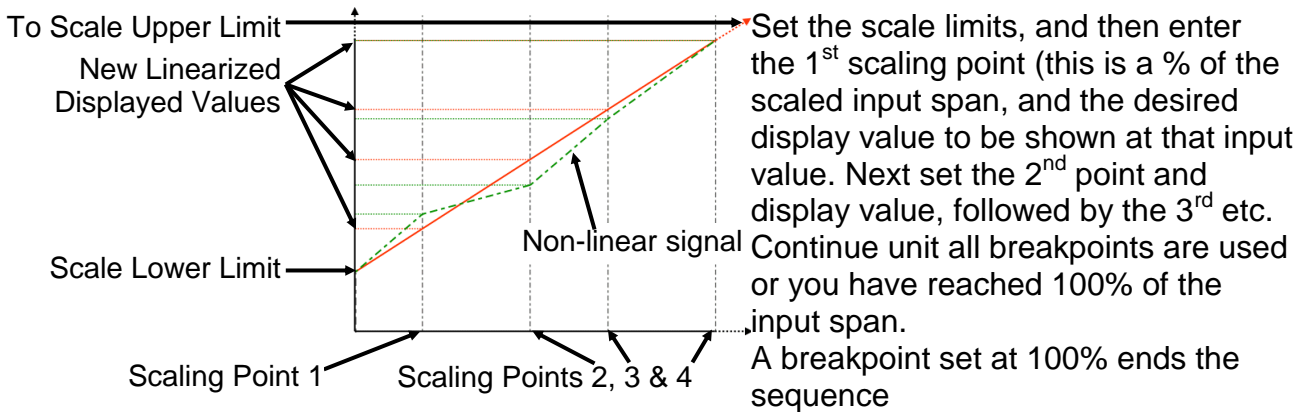

Figure 46. Multi-point Scaling

Base Calibration Adjustment

Calibration of each input type is carried out during manufacture. This can be verified in the Service and Product Info screens.

Re-calibration of the internal base values is possible, but should only be attempted by qualified personnel as it overwrites the factory calibration.

For most applications, base re-calibration is not required during the lifetime of the instrument.

WARNING:

BASE CALIBRATION SHOULD ONLY BE PERFORMED IF ERRORS HAVE BEEN ENCOUNTERED. REFER TO CALIBRATION CHECK BELOW.



CAUTION: Any calibration adjustment must only be performed by personnel who are technically competent and authorised to do so. The equipment used must be in a known good state of calibration.

Required Equipment

To verify the accuracy of the instrument or to carry out recalibration, a suitable calibration signal source is required for each input type as listed below. Accuracy must be better than $\pm 0.05\%$ of reading:

1. DC linear inputs: 0 to 50mV, 0 to 10VDC and 0 to 20mADC.
2. Thermocouple inputs - complete with 0°C reference facility, appropriate thermocouple functions and compensating lead wire.
3. RTD inputs: decade resistance box with connections for three-wire input.

Performing a Calibration Check

1. Setup input 1 for the input signal type to be checked.
2. Power up the instrument and correctly connect the signal source.
Leave powered up for at least five minutes for RTD and DC linear inputs, and at least 30 minutes for thermocouple inputs.
3. After the appropriate delay for stabilisation, check the calibration at a number of cardinal points by applying the appropriate input signal.
The observed readings should be within the tolerances stated in the specifications (see page 245).
4. Test the other signal types as above if required.
5. Repeat the process for input 2 if fitted.

Recalibration Procedure



For each process input, recalibration is carried out in five phases as shown in the table below; each phase corresponds to a basic input type.



Note: The 50mV calibration phase MUST always be calibrated before calibration of the thermocouple input.

INPUT CALIBRATION PHASES						
Type	Signal (<0.05% error)	Cable Type	Input 1 Terminals		Input 2 Terminals	
			+	-	+	-
DC milli-volt	50 mV	Copper Wire	2	3	6	7
DC voltage	10 V	Copper Wire	2	3	6	7
DC milliamps	20 mA	Copper Wire	3	1	7	5
RTD	200 ohm	Copper 3-Wires	1	2 & 3	5	6 & 7
Thermocouple	0°C K type source	K Thermocouple Wire	2	3	6	7

1. For optimum accuracy, leave the instrument power-up for >30 minutes to warm up before beginning the calibration, and then toggle the power off/on to restart the instrument.
2. During the power-up “splash screen”, press and together until the Input 1 Calibration Status screen is displayed.
3. Correctly connect the 1st phase signal (50mV), then press to select the first phase
4. Press + to initiate the calibration.
5. During calibration the message “50mV DC Input Calibrating” will display for a few seconds. This should be followed by the “Calibration Successful” confirmation.

6. If the input is misconnected or an incorrect signal is applied, the calibration will be aborted and the values will not be altered. The display will show “Failed: Signal Too Small!” or “Failed: Signal Too Large!”. Correct the problem and repeat that phase before continuing.
7. Press  to select the next calibration phase.
8. Repeat this process for each input type until all the phases are calibrated. For each phase, ensure that the correct input is applied, using the appropriate connections.
9. If the instrument has 2 process inputs, when the first input sequence completes, the Input 2 Calibration Status screen is displayed. Repeat the procedure from 3 above for this input.
10. Once calibration is complete, recorder versions will ask for a Calibration Reminder Date. If required, this can be changed to the date of your next calibration check. Ensure that Calibration Reminders are enabled in Input Configuration to receive a reminder.
11. Press  +  to exit to the main menu.



Note: *The Calibration Mode automatically exits if there is no button activity for two minutes.*

10 Digital Inputs

Digital inputs are driven to one of two states (active or inactive) by an applied voltage signal or a contact opening/closing.

A total of 9 physical digital inputs are possible on this instrument. A multiple digital input can be installed at time of purchase, and a single plug-in module can be fitted in option slot A.

Digital Signal Type

The digital inputs can be connected to volt-free contacts, or to a voltage signal (compatible with TTL). They can often be used in parallel with equivalent menu selections, where either can change function status.

Some inputs are level sensitive, while others are edge sensitive requiring a High to Low or Low to High transition to change functions status. Pre-Tune is always off at power-up (except if auto pre-tune is enabled), but other edge sensitive functions retain their power off status at power on. *See the tables below for details.*

Open contacts (>5000Ω) or 2 to 24VDC signal = Logic High (*logic low if inverted*).
 Closed contacts (<50 Ω) or -0.6 to +0.8VDC signal = Logic Low (*logic high if inverted*).



CAUTION: The response time is ≥0.25 seconds. Signals applied for less than this time may not register and the function might not change state.



A diagnostic screen assists commissioning and fault finding by showing the current signal state for all digital inputs.

Slot A, C1 to C8 & Soft digital input status (☑ = Active, ⊘ = Unavailable)

Profile select bit format (BCD or Binary)

Profile selected (example shown: C1-C3 = 011 = 6)

Inverting Digital Inputs

Digital inputs can be inverted to reverse their action making an “on” input behave as off. Step through each input using the **▶** key. Press **⬆** to invert the highlighted input and **⬇** to un-invert . Hold **▶** down to skip to next screen accepting the values shown.

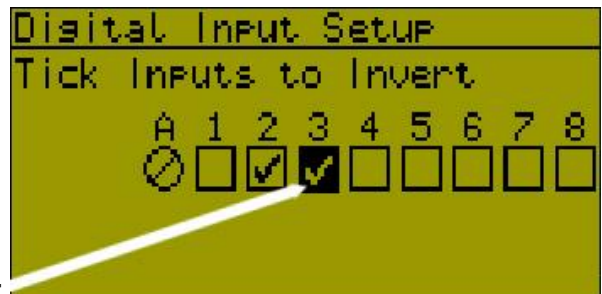

Highlighted Input

Soft Digital Inputs

In addition to the physical digital inputs, four “soft” digital inputs are available. They are used to select functions in the same way as the physical inputs.

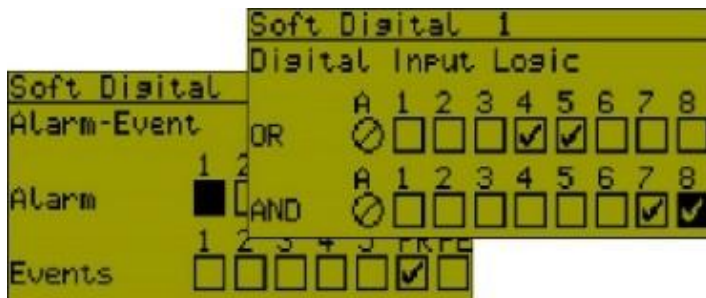

The four soft digital inputs can be configured by combining physical inputs, alarms & events using Boolean logic. Input AND selections are then globally OR'd with the input OR selections, the alarms & the events. By using the invert inputs function, NAND & NOR equivalents can be created.

Digital Input Functions

Some or all of inputs C1 to C7 can be used for profile selection. If used in this way they cannot be used for any other functions. Soft inputs and any physical digital inputs not allocated for profile selection can be used to change the instrument status. Each input can only perform a single function. The possible functions are listed below.

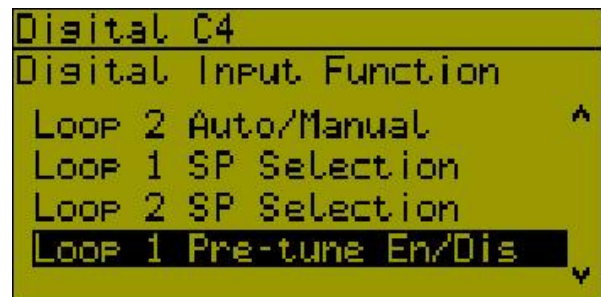

Single Functions

Digital inputs can often work in parallel with equivalent menus, where either can change function status.

In the table below, ■ = Level Sensitive: Where a High or low signal sets the function status. ▮ ▮ = Edge Sensitive: High-Low or Low-High transition changes the function status. Pre-Tune is always off at power on (except if auto pre-tune is in use), and profile recovery is as configured, but others functions retain their power off status when the power returns.

Function	Logic High*	Logic Low*	Sensitivity / Functions' Power On State
Loop 1 Control Select	Enabled	Disabled	▮ ▮ / Retained
Loop 2 Control Select	Enabled	Disabled	▮ ▮ / Retained
Loop 1 Auto/Manual Select	Automatic	Manual	▮ ▮ / Retained
Loop 2 Auto/Manual Select	Automatic	Manual	▮ ▮ / Retained
Loop 1 Setpoint Select	Main SP	Alternate SP	▮ ▮ / Retained
Loop 2 Setpoint Select	Main SP	Alternate SP	▮ ▮ / Retained
Loop 1 Pre-Tune Select	Stop	Run	▮ ▮ / OFF
Loop 2 Pre-Tune Select	Stop	Run	▮ ▮ / OFF
Loop 1 Self-Tune Select	Stop	Run	▮ ▮ / Retained

Loop 2 Self-Tune Select	Stop	Run	▯ / Retained
Profile Run/Hold	Hold	Run	▯ / As configured
Profile Hold Segment Release	No Action	Release	▯ / Retained
Profile Abort	No Action	Abort	▯ / As Digital Input
Data Recorder Trigger	Not Active	Active	▯ / As Digital Input
Output <i>n</i> Forcing	Off/Open	On/Closed	▯ / As Digital Input
Clear All Latched Outputs	No Action	Reset	▯ / As Digital Input
Output <i>n</i> Clear Latch	No Action	Reset	▯ / As Digital Input
Key <i>n</i> Mimic (for ⏪ ⏩ ⏴ ⏵)	No Action	Key Pressed	▯ / As Digital Input

Profile Selection via digital inputs

For instruments with the profiler option, the multi-digital input option can be used to select the profile to run using either a standard binary bit pattern, or binary coded decimal from BCD switches. Profile selection inputs are all level sensitive (▯), with a high/open signal equating to a binary 1 (assuming non-inverted), and a low/closed signal equating to a binary 0 (assuming non-inverted).

Profiles are numbered 0 to 63. Select inputs C1 to C*n* for the required number of profiles, from the table:

	C1	C1 to C2	C1 to C3	C1 to C4	C1 to C5	C1 to C6	C1 to C7
Binary	0 to 1	0 to 3	0 to 7	0 to 15	0 to 31	0 to 63	
BCD	0 to 1	0 to 3	0 to 7	0 to 9	0 to 19	0 to 39	0 to 63
Using Binary To Select Profile Numbers							
Selection of profiles is via a simple binary bit pattern. C1 is the least significant bit (LSB).							
	C6 to C1	C5 to C1	C4 to C1	C3 to C1	C2 to C1	C1	
	000000 to 111111 (0 to 63)	00000 to 11111 (0 to 31)	0000 to 1111 (0 to 15)	000 to 111 (0 to 7)	00 to 11 (0 to 3)	0 to 1 (0 to 1)	
Using BCD To Select Profile Numbers							
A single BCD switch can be used to select profiles 0 to 9 using C1 to C4, with a bit pattern identical to standard binary. For larger numbers, a double BCD switch arrangement is needed. A separate binary pattern is applied to C5 to C7 for the “tens” digit (10 = 001, 20 = 010, 30 = 011 etc). Any number combination higher than 63 is invalid.							
Multiples of ten (0x to 6x)				Multiples of one (x0 to x9)			
	C7 to C1	C6 to C1	C5 to C1	C4 to C1	C3 to C1	C2 to C1	C1
	000 to 110 (0x to 6x)	00 to 11 (0x to 3x)	0 to 1 (0x to 1x)	0000 to 1001 (x0 to x9)	000 to 111 (x0 to x7)	00 to 11 (x0 to x3)	0 to 1 (x0 to x1)

11 Cascade Control

Applications with long time lags (e.g. with two or more capacities such as heated jackets) can be difficult to control with a single control loop. The solution is to split the process into two or more cascaded loops consisting of a Master and Slave(s) acting on a common actuator. Ideally, the slave loop's natural response time should be at least 5 times faster than the master.

The master controller measures the process temperature and compares it to the desired product setpoint. Its correcting variable (0 to 100% PID output) becomes the slave's effective setpoint (scaled to suit the process). This setpoint is compared to the slave's process input, and the controlling actuator is adjusted accordingly.



Note: Cascade control is only available on models fitted with the 2nd control loop. The master loop uses input 1; and the slave loop uses input 2.

Example Cascade Application

In this example the controlling actuator is a heater, indirectly heating the product via an oil jacket. The maximum input to the slave represents 300°C, thus restricting the jacket temperature. At start-up the master compares the product temperature (ambient) to its setpoint (250°C) and gives 100%. This sets the maximum slave setpoint (300°C), which is compared to the oil temperature (ambient) and the slave requests maximum heater output.

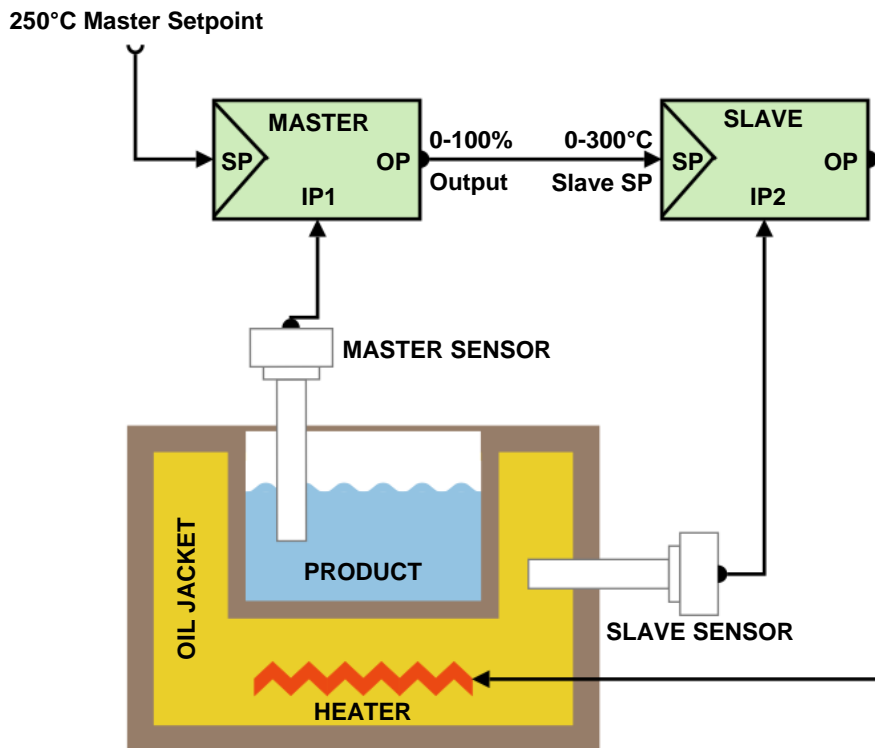

Figure 47. Cascade example

As the oil temperature rises towards the slave setpoint, its output falls. Gradually, the product temperature will also begin rising, at a rate dependant on the transfer rate/lag between the oil jacket and the product. Eventually this causes the master's PID output to decrease, reducing

the slave setpoint. The oil temperature is reduced towards the new slave setpoint. This continues until the system becomes balanced. The result is quicker, smoother control with the ability to cope with changes in the load. Overshoot is minimised and the jacket temperature is kept within acceptable tolerances.

Normal Cascade Operation

During operation, the master and slave are coupled together and. "**Cascade**" is displayed. The master process value and setpoint are most relevant to the user. The master setpoint is directly adjustable. The process value of the slave controller is displayed for information only.

Cascade-Open

The cascade can be disconnected (via digital inputs or menu selection), switching from normal operation to direct control of the slave. "**Cascade-Open**" is displayed. Opening the cascade is "Bumpless". The current cascade value is used as the initial slave setpoint (displayed as "**SlaveSP**"). The process is then controlled and adjusted solely by the slave controller using this setpoint. Switching back to Cascade is also bumpless.



CAUTION: The master process value is not under control when the cascade is open, but will be affected by the slave process. The operator is responsible for maintaining safe conditions.

Manual Mode

The controller can be put into manual mode (via digital inputs or menu selection), switching from normal operation to direct control of the slave loop's correcting variable. Manual power is adjusted from 0% or -100 to 100%. "**MAN**" is displayed.



CAUTION: Manual mode disables the cascade loop. It also ignores any output power limits, valve open/close limits and the control enable/disable setting. The operator is responsible for maintaining the process within safe limits.

Cascade Tuning

The user can tune the slave and master loops manually, or use the pre-tune feature (see Controller Tuning on page 99).

In either case the slave control loop must first be optimised on its own, followed by the master loop in combination with the previously tuned slave.

To automatically pre-tune a cascade:

1. Go to the Automatic Tuning menu
2. Select "Cascade-Open" from the pre-tune menu to tune the PID set(s) on the slave.
3. After the slave has successfully tuned, pre-tune the master/slave combination by selecting "Cascade-Closed" from the pre-tune menu.



Note: *The cascade remains open until you pre-tune the master or manually select Cascade-Closed.*

To manually tune a cascade:

1. Select Cascade-Open from the Cascade Control menu, breaking the link between the master and slave loops.
2. Set the slave controller setpoint manually to the appropriate value for your application.
3. Tune the slave for relatively fast control ('proportional only' is often sufficient).
4. Select Cascade-Closed from the Cascade Control menu to link the master and slave loops, then tune the master/slave combination.

12 Ratio Control

A ratio control loop is used where the quantity of one of the material is to be controlled in proportion to the measured quantity of a second material. The controller mixes the materials at the desired ratio by adjusting the flow of input 1. The flow of input 2 may be controlled separately, but is not controlled by the ratio control loop itself.

The process value used by the controller is therefore determined by the ratio of the two inputs rather than a single measured variable.



Note: *Ratio control is available on models with the 2nd Auxiliary Input, or two loop models. The feature and information displayed is optimised for control of burner fuel/air, but can be used in other flow ratio applications.*

Stoichiometric Combustion

Below is an example of stoichiometric combustion ratio control. For optimum combustion the fuel-air ratio is set so that there are no flammable residues in the waste gas.

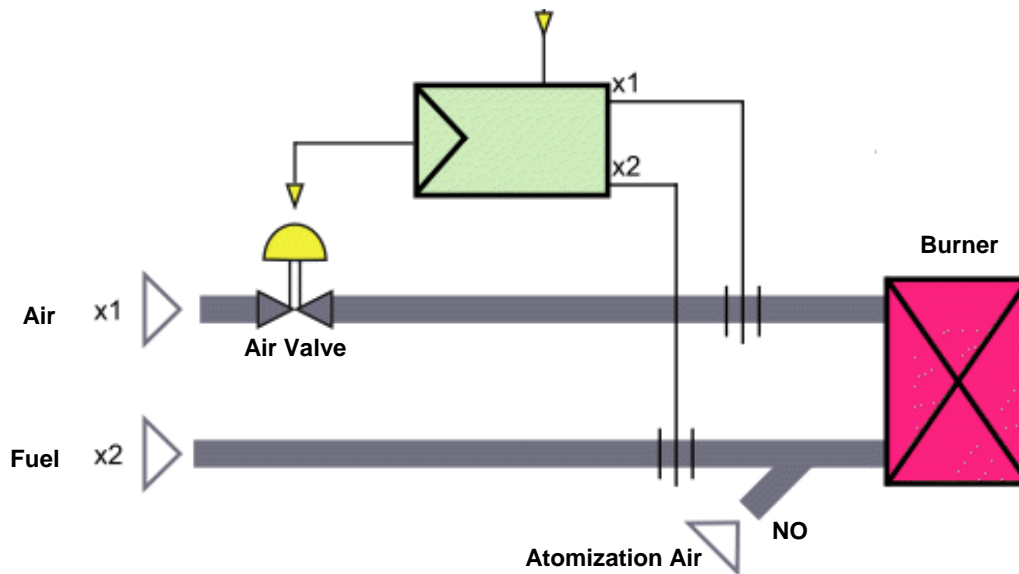

Figure 48. Ratio Control Example

It is normal in this application to display the process value and setpoint as relative values rather than the physical ratio or absolute values. A scaling factor is set such that the displayed value will be 1.00 at the correct stoichiometric ratio for the application.

Inputs 1 and 2 are configured and scaled to match the attached flow meters.

In this example a 4 to 20mA signal at x1 represents 0 to 1000m³/h of airflow controlled by a valve. The second 4 to 20mA signal at x2 represents 0 to 100m³/h of fuel oil. The fuel flow is not affected by this control loop.

Atomizing air is fed in with the fuel oil at a constant rate 'NO'. This must be considered when calculating the correct fuel/air mix. Total airflow is x1 + NO.

The stoichiometric factor, *SFac* is entered to match the desired ratio. E.g for 10 parts total airflow to one part fuel, *SFac* would be 10.

The setpoint (entered as a relative value such as 1.00) is multiplied by *SFac* when calculating the control deviation. E.g. with a setpoint of 1.00 and *SFac* of 10 the controller

attempts to make the physical ratio 10. With a setpoint of 1.03 it would attempt to make the ratio 10.3 for 3% excess air.

The instantaneous (controlled) process value is calculated from the physical ratio, divided by *SFac*. Like the setpoint, this is displayed as relative value.

E.g. if *SFac* is 10, with 59.5m³/h airflow measured at *x1*, 0.5m³/h atomising air applied at *NO* and 6m³/h fuel is measured at *x2*, the instantaneous process value would be:

$$\frac{x1+NO}{x2*SFac} = \frac{59.5+0.5}{6*10} = 1.00$$

If fuel flow remained at 6m³/h and the setpoint was adjusted to 1.05 (5% excess air), the controller would increase the *x1* air flow to 62.5m³/h.

$$\frac{x1+NO}{x2*SFac} = \frac{62.5+0.5}{6*10} = 1.05$$

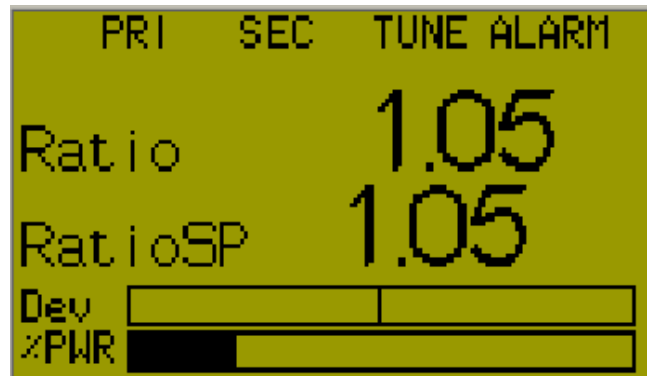

Typical Ration display with Setpoint at 1.05

13 Redundant Input

If the 2nd universal input is fitted, the second input can be configured as a redundant input for the main process input. This increases process security by protecting against the possible loss of valuable product resulting from sensor failure.

A second sensor is connected to input 2 so that if the main sensor fails, the instrument automatically switches to this backup or “redundant” sensor.

In this condition, if input 1 has a signal break alarm configured it will activate, but any other process input or control status alarms seamlessly switch to the 2nd input. The 2nd input continues to be used until the signal to input 1 is restored.



Note: *The user may not even be aware of a sensor fault, so it is strongly recommended that signal break alarms are configured for both inputs to provide a notification if problems occur.*

The redundant sensor must be of the same type, and be correctly located in the application ready to take over if needed. If the redundant input option is selected, the 2nd input cannot be used for other functions.



Note: *If both signals are lost at the same time, the PV value display is replaced with “**OPEN**” and the normal sensor break actions occur.*

14 Valve Motor Drive / 3-Point Stepping Control

When directly controlling the motor of a modulating valve or damper, set the Control Mode to VMD in configuration mode to enable the 3-point stepping Valve Motor Drive control algorithm.

The term “3-point stepping” is used because there are 3 output states, open valve, close valve or stopped (no action). Switched outputs move the valve further open, or further closed when a control deviation error is detected. If the error is reduced to zero, no further output is required until the load conditions change.

VMD mode doesn't allow on-off control (the minimum proportional band equates to 0.5% of the scaled input span) and usually requires PI control, where the derivative parameter is set to OFF.



Note: *Some modulating valves have positioning circuitry to adjust the valve position. These require a DC linear mA or voltage output and use the standard control algorithm (Set Control Mode to Standard).*

Special Wiring Considerations for Valve Motor Control

Valve motor drive mode must have two identical outputs assigned to position the valve. One to open and one to close the valve. These outputs can be two single relays, two triacs, two SSR drivers or one dual relay, but it is recommended to use two single relays (SPDT change-over contacts), and to interlock the wiring as shown. This prevents both motor windings from being driven at the same time, even under fault conditions.

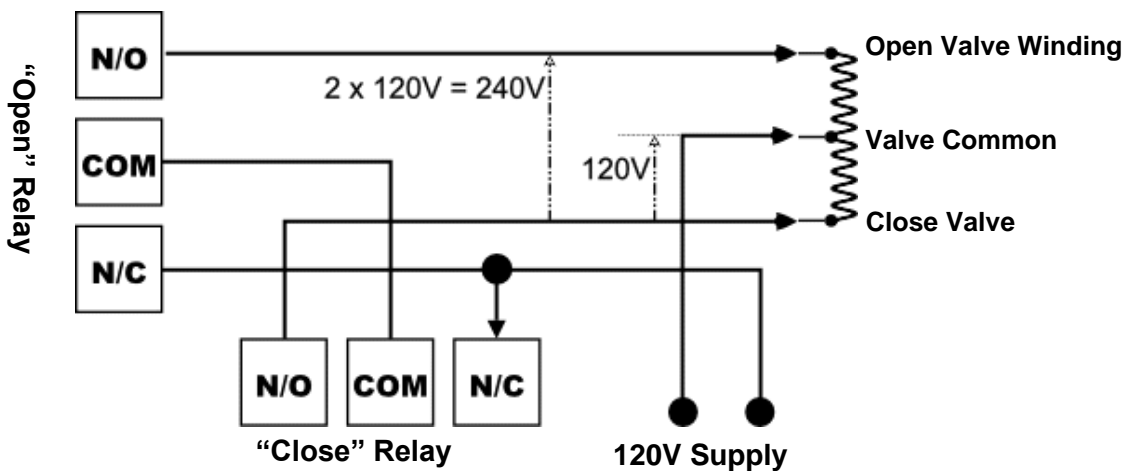

CAUTION: The windings of a valve motor effectively form an autotransformer. This causes a voltage doubling effect when power is applied to either the Open or Close terminal, causing twice the supplied voltage at the other terminal.

Switching actuators directly connected to the valve motor must only be used up to half of their rated voltage. The internal relay and triac outputs in this instrument are rated at 240VAC. Therefore, the maximum motor voltage when using them is therefore 120V unless interposing relays are used. Interposing relays or other devices used to control the valve must themselves be rated for twice the motor supply voltage.

Position Feedback

In VMD mode this instrument uses a boundless (open-loop) 3-point stepping algorithm. It does not require any kind of position feedback in order to correctly control the process and can therefore avoid problems associated with faulty feedback signals.

However, where valve feedback is available it can still be displayed in a bar-graph as a percentage open (0 to 100%). Position feedback is usually provided by means of a potentiometer mechanically linked to the valve. The output of a related flow meter can also be used to indicate the relative valve position. Flow meters typically have linear 0-20/4-20mA or 0-5/0-10V signals. To display the position/flow signal the 2nd input must be configured for this purpose.

The input is adjusted and scaled to show 0 to 100% representing valve fully closed to fully open, or a flow rate equating to fully closed to fully open. The valve position scaling parameters are set in the Input Configuration sub menus – see *page 46*.

Valve Limiting

When valve position/flow indication is in use, the signal can be used by the controller to limit the valve movement. Upper and/or lower limits can be set beyond which it will not attempt to drive the valve. The valve open and close limits are set in the Control Configuration sub menu – see *page 50*.



CAUTION: These limits must be used with care. They are effectively control power limits. Do not set values that prevent proper control of the process!

15 Setpoint Sources

The setpoint is the target value at which the instrument attempts to maintain the process variable. Each loop can have a Main “local” setpoint set from the keypad and an Alternate setpoint.

Loop 1 Setpoint Sources

Loop 1 can have a Main “local” setpoint set from the keypad and an Alternate setpoint. The alternate setpoint source can be either another local Setpoint or a remote setpoint (RSP), set by a mA or V DC signal applied to the 2nd input or to auxiliary input A. The control loop can only use one setpoint source at a time for each loop. This is called the “Active Setpoint”. If the profiler option is fitted this provides the setpoint when the profiler is in use, replacing both main and alternate setpoints.

Main/alternate setpoint selection can be made via a digital input; from the Control Configuration menu or if enabled in the Display Configuration sub-menu, an operator screen can be used to select the setpoint. The chosen setpoint selection method can be used to permanently select one of the setpoints, or allow switching between them.

Refer to the Control Configuration Sub-Menu Screens on page 50 for setpoint settings.

Loop 1 Profile Setpoint

When in profile control mode, the selected profile always provides the active setpoint source for loop 1 (see page 87). Once profile control mode is exited, the selected main or alternate setpoint for loop 1 becomes active again.

Loop 2 Setpoint Sources

Loop 2 can have a Main “local” setpoint set from the keypad and an Alternate setpoint. The alternate setpoint source can be either another local Setpoint or a remote setpoint (RSP), set by a mA or V DC signal applied to auxiliary input A. The control loop can only use one setpoint source at a time for each loop. This is called the “Active Setpoint”. If the profiler option is fitted this provides the setpoint, replacing both main and alternate setpoints, when 2-loop profiling is in use.

Main/alternate setpoint selection can be made via a digital input; from the Control Configuration menu or if enabled in the Display Configuration sub-menu, an operator screen can be used to select the setpoint. The chosen setpoint selection method can be used to permanently select one of the setpoints, or allow switching between them.

Refer to the Control Configuration Sub-Menu Screens on page 50 for setpoint settings.

Loop 2 Profile Setpoint

If the selected profile was configured to control the setpoint of both loops, it will provide the active setpoint source (see page 87). Once profile control mode is exited, the selected main or alternate setpoint for loop 2 becomes active again.

16 Profiler

This section covers the Profiler (*or setpoint programmer*) option. To confirm if profiling is enabled on your controller, refer to the Service & Product Info menu (see page 67).

Introduction

The Profiler feature allows the user to store up to 255 profile segments, shared between a maximum of 64 Profiles. Each profile controls the value of the setpoint over time; increasing, decreasing or holding their values as required. The profile can control both setpoints if the 2nd control loop is fitted.

Profiler options and screens are added to the Main Menu and Operation Mode – See pages 63, 66 & 36.

Profiler Enabling

Controllers supplied without the Profiler option installed can be upgraded by purchasing a licence code number. Refer to the Field Upgrade information on page 4.

To obtain the correct code you must tell your supplier the instrument serial number – this can be found in the Service & Product Info menu (see page 67).

To enter the licence code, hold down the  +  keys during the power-up splash screen. Enter the 16-character licence code in the displayed screen and press .

Profile Components

General profile configuration settings apply to all profiles. They enable or disable “profile editing while running”, and automatic starting of the selected profile if it has been configured with a delay or day & time start trigger.

If delay or day & time start triggers are disabled, profiles can only be manually started, and this is with immediate effect even if they have a delay or day & time trigger defined. If delay or day & time start triggers are enabled, delayed starts are possible, and if the selected profile has a day & time trigger it will wait until the time set and before starting.



Note: *Even if profile editing is enabled, changes to the current and next segment or a running profile will not take effect until the profile is next run. Changes to other segments will take effect immediately.*

Profile Header & Segment Information

Each profile has its own header information plus 1 or more segments. The header information is unique for each profile, it contains the profile's name; if it controls just one or both loops; how it should start & stop; the abort & power-loss recovery actions; and how many times it should be repeated.



Note: *Profile Header information is only stored to memory as the Segment creation sequence begins. No profile is created if you exit before this point. Segment information is stored as each segment is created, but the profile remains invalid until an end or join segment is defined.*

Segments can be ramps, dwells, steps or special segments such as holds, ends, joins or loop-backs.

If the instrument also has the data recorder option, its real time clock (RTC) expands the profiling capabilities by adding Day & Time profile start options, releasing of hold segments at a specific time of day and changing the power fail recovery option to one based on the length of time the power has been off. These features are explained below and in the Profiler Setup and Profile Control menus (See pages 63 & 66).

Profile Starting & Standard Segments

The example profile below explains the standard segment types required to make a simple profile or profile sequence. A **Start Trigger** is the instruction to begin the selected profile. This can be from the profile control menu, a digital input signal, via a serial communications command or if enabled in the display configuration, the profile can be controlled from an operator screen.

Following a Start Trigger, profiles can start immediately, after a delay, or using the Day & Time start timer (*Day & Time start available on with the Recorder option only*). Following the start trigger, the remaining delay time or the start day & time are shown in the profile status bar-graph until the profile begins running.



Note: Profiles outside current setpoint limits will not run, A “profile not valid” error shows if you attempt to run a profile under these circumstances.

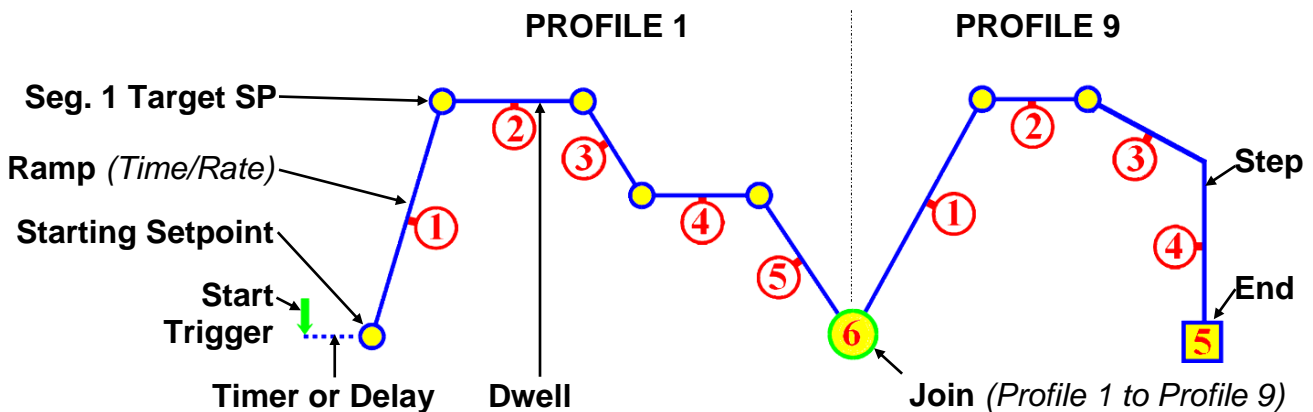

Figure 49. Profile Starting and Standard Segment Types

Ramps and Step Segments have target setpoint that they will reach as they finish. If a segment is a **Ramp-Time** type, the slope needed to reach the target setpoint in the defined time will change depending on the starting setpoint value. For a **Ramp-Rate** segment, the slope is defined by the segments Ramp Rate, so the time to reach the target setpoint will change instead. This is of particular significance for the first segment, since the starting value of the process may not be known in advance.



Note: When using the instrument as a two loop profiler Ramp-Rate type segments are not available. Calculate the time from the starting value to the target setpoint and use Ramp-Time instead.

A **Dwell** (often called a “soak”) holds the previous setpoint value for the specified dwell time. **Step** segments jump straight to the new target setpoint value. An **End** segment ends the profile or profile sequence. If the last segment is a **Join**, the “join target” profile will begin running.



Note: *If the join target has been deleted the profile sequence will abort and the last profiles abort action will apply.*

Two Loop Profiles

If the instrument is configured to control two control loops, the setpoint of both loops can be maintained when profiling. Both setpoints are synchronised to a common segment time-base, but have independent target setpoints for each of the segments.



Note: *When using the instrument as a two loop profiler Ramp-Rate type segments are not available. Calculate the time from the starting value to the target setpoint and use Ramp-Time instead.*

The example below shows how two loop profiling works in practice. Auto-Hold settings and target setpoints are independent for each loop, but the segment types and time settings are the same.

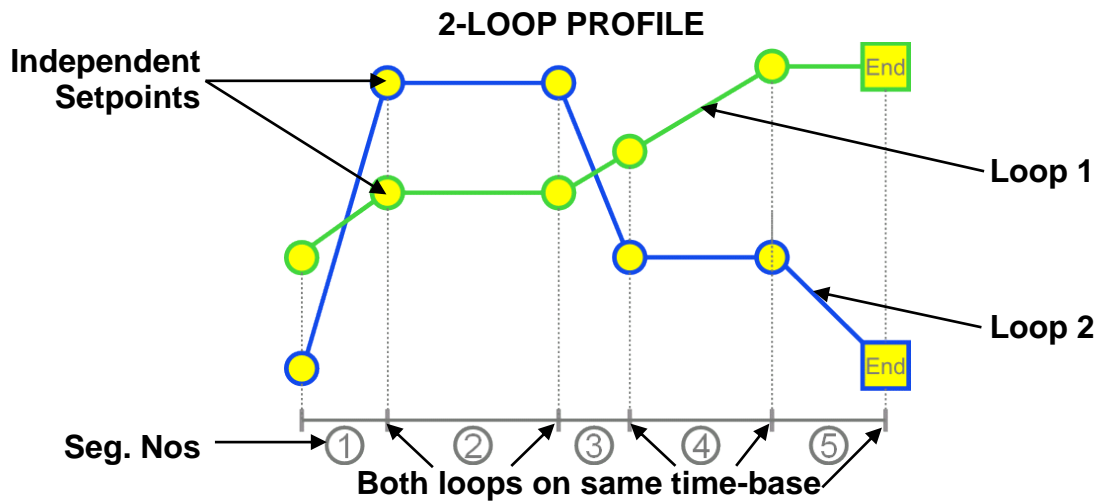

Seg. ① & ② shows a ramp and a dwell with the shared time base. The ramp direction can be different (Seg. ③), and although one loop cannot ramp while the other dwells, a "dwell" is achieved by a ramp with its final setpoint value at the same value as the previous segment (Seg. ④). Similarly, if only one loop is to Step to a new value, make the other "step" to its existing setpoint value. If you later change the previous setpoint, you may have to change both segments.

The Loop-back feature takes both loops back to the same defined earlier segment.



Note: *Auto-Hold settings are independent for each loop. Either loop can cause the profile to auto-hold, holding both loops at the current setpoint value. The profile continues only when both loops are back within their hold bands.*

Loop-back Segments

A **Loop-back** segment goes back to a specified segment in the current profile. This action is repeated for the required number of times (1 to 9999) before the profile continues onwards. More than one Loop Segment can be used in a profile, but they cannot cross.

Example:
Runs segments 1 to 5, then repeats segments 3 to 5 again 500 times, before continuing on to segments 7

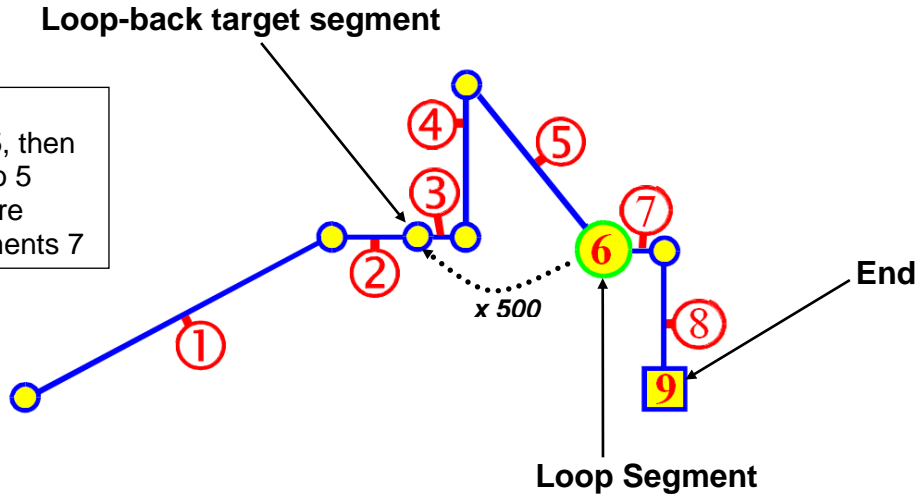

Figure 50. Loop-back Segments

Profile Running / Holding vs. Hold Segments

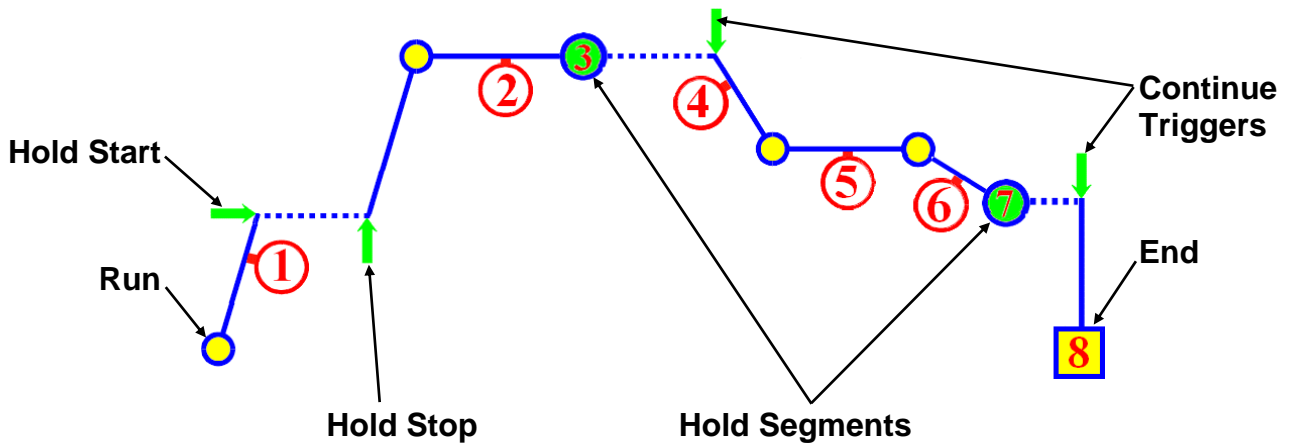

Figure 51. Run/Hold & Hold Segments

A **Hold** condition during a segment maintains the current profile setpoint value(s). Once the hold condition is stopped the Ramp or Dwell continues. The user can request that the profile holds, or it can be instigated automatically.



Note: A running segment will hold if the operator or a digital input instructs it to. It can also hold due to “auto-hold”, if one of the profile control loops is disabled, if a cascade is set to “open” or if manual control is selected.

A **Hold Segment** is a pre-planned hold programmed into the profile. It maintains the value of the previous segment and the profile does not continue until a **Continue Trigger** occurs. This can be via a key-press, serial communications, a digital input signal or after waiting until a pre-set time of day (*time of day is available with the recorder option only*).

The Auto-Hold Feature

There are independent auto-hold settings for each segment of each loop controlled by the profile. When utilised, auto-hold ensures that the profile and the actual processes remain synchronised. If the process does not closely match the setpoints (within the defined **Hold Bands**), the profile will be held until it returns within bounds.

When Auto-Hold becomes active, the profile status is shown as “Held”.



Note: The segment time is increased by the time that the process is out of bounds, extending the total profile run time.

Auto-hold can be configured to hold the profile if the process goes beyond the hold band **Above The Setpoint** only, **Below The Setpoint** only or it can be set to **Band** (either side of the setpoint).



Note: For two-loop profiles, either loop can cause the profile to hold. The entire profile (i.e. both loops) will be held if either process is outside of its auto-hold band. It continues only when both loops are back within their auto-hold bands.

Auto Hold Examples

Auto Hold on Dwells

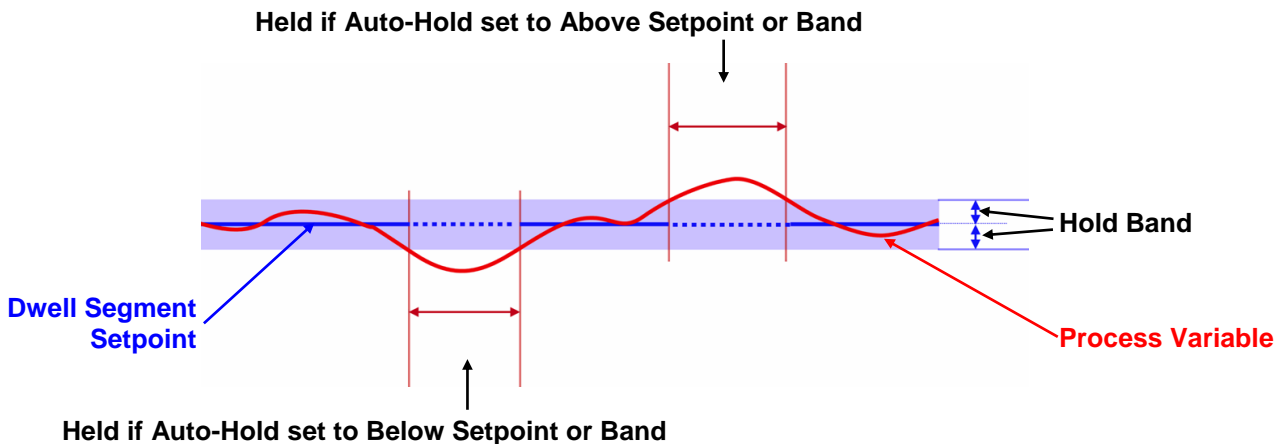

Figure 52. Auto-Hold on a Dwell Segment

During a Dwell, the dwell time is increased by the time that the process is outside of the hold band in the selected direction(s). This ensures the process was at the desired level for the required amount of time.

Auto Hold on Ramps

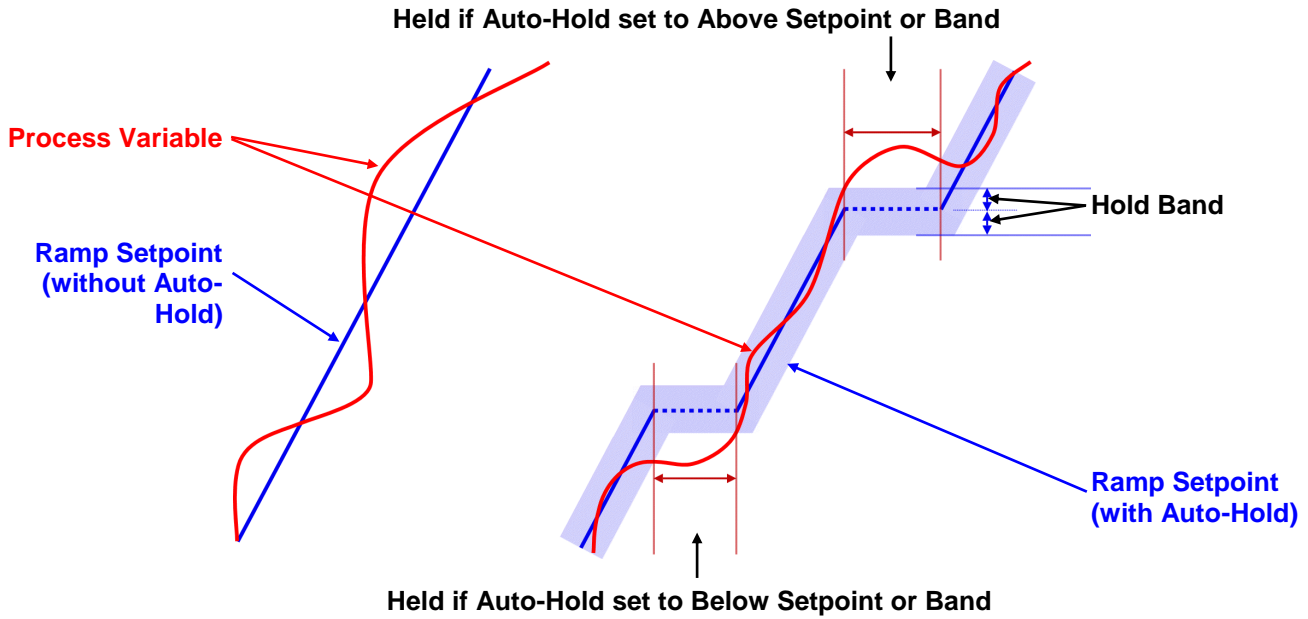

Figure 53. Auto-Hold On A Ramp Segment

During a Ramp segment, the ramp is held at the current setpoint value while the process is outside of the hold band in the selected direction(s). The time taken to complete the ramp is increased by the time taken by the Auto-Hold.

Profile Cycles & Repeat Sequences

A profile can be configured to run itself from 1 to 9999 times or continuously using the Profile Cycles setting. A profile ending with **Repeat Then End** will run the entire sequence of profiles again from 1 to 9999 times before ending.

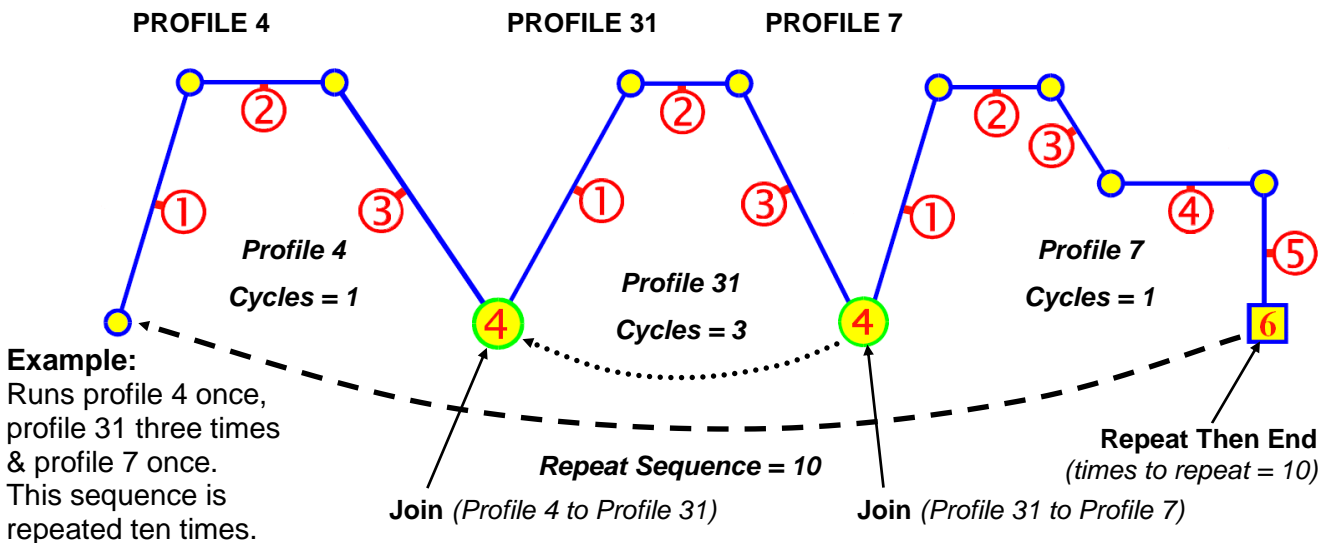
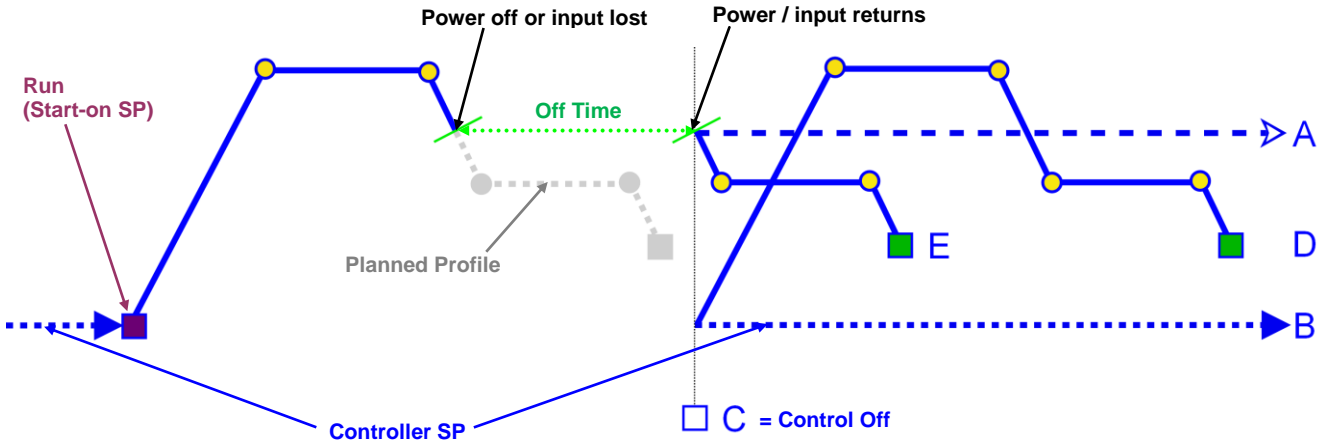

Figure 54. Profile Cycles & Repeats

Power/Signal Lost Recovery Actions

If the power is cut or the input signal is lost while a profile is running, the instrument will use the defined **Profile Recovery Method** once the signal / power returns. The profile recovery method is set in the profile header.

The possible profile recovery options are explained below.



Possible Recovery Methods:

- A** End the profile and maintain the setpoint value(s) from the time the power failed.
- B** End the profile and use Controller Setpoint value(s).
- C** End the profile with the Control outputs off - *setpoint value replaced by "OFF"*.
- D** Restart the profile again from the beginning.
- E** Continue profile from the point it had reached when the power failed

Figure 55. End, Abort and Recovery Actions



Note: Recorder versions always use option E (Continue profile) if the "off time" is less than the Profile Recovery Time setting. If the "off time" is longer, the defined Profile Recovery Method is used.



Note: With option E, after the power returns profile bar graph resets and shows the remaining/elapsed time for the profile only since re-starting.

Profile End Actions

Once a running profile ends, that profiles' **Segment End Type** defines the action taken by the instrument. If a sequence of profiles are joined together, the End Segment Type of the last profile in the sequence will be carried out when it completes. The end segment type is set in the final profile segment data.

The possible profile end actions are explained below.

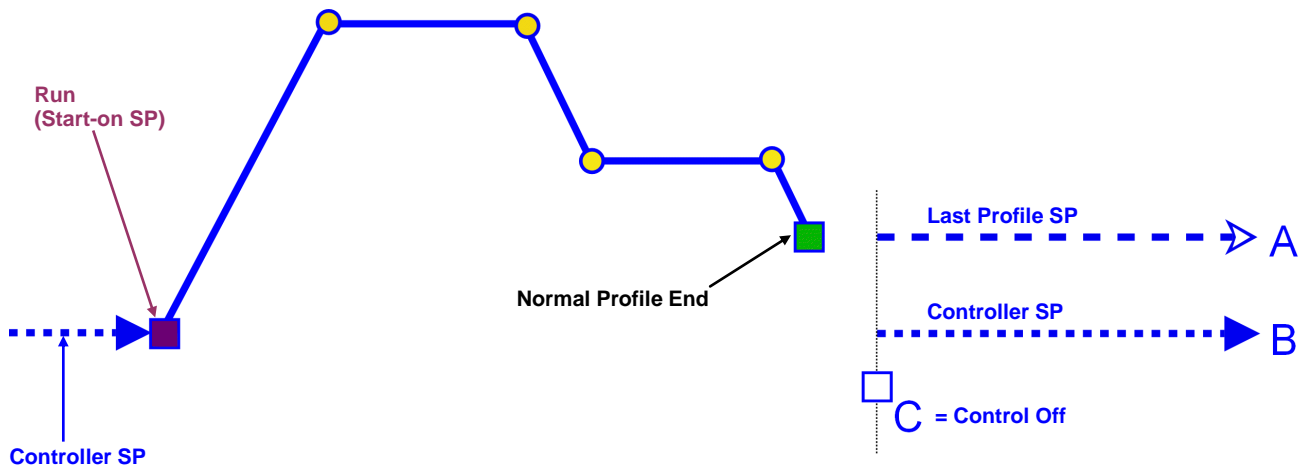

Possible Profile End Actions:

- See **A** At profile end, maintain the Final Setpoint value(s) of the last segment.
 note **B** At profile end, exit Profiler Mode and use the Controller Setpoint value(s).
 below **C** At profile end, remain in Profiler Mode with the Control outputs off.

Figure 56. Profile End Action



Note: Note: *When using two loop profiles, the end-action applies to both loops, but each ends with its own individual setpoint in line with the method chosen.*

Profile Abort Actions

If a running profile is forced to end early, the **Profile Abort Action** defines action taken by the instrument. The profile abort action is set in the profile header.

If a profile sequence is forced to end early, the profile abort action of the current segment will be used.

The possible abort options are explained below.

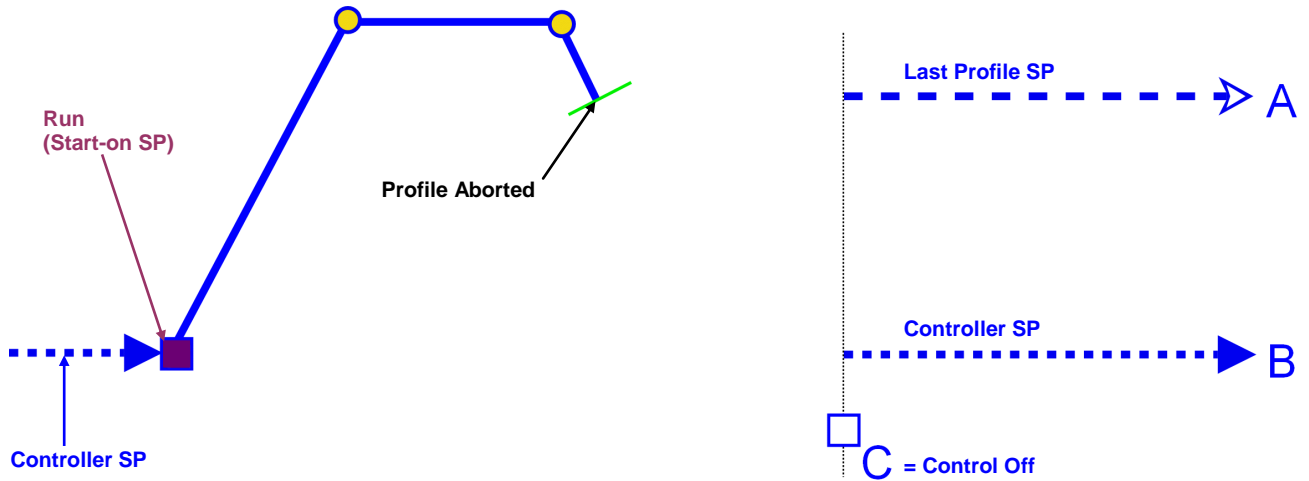

Possible Profile Abort Actions:

- See **A** Abort the profile and maintain the value of the setpoint at the time of the abort.
- note **B** Abort the profile and exit Profiler Mode using the Controller Setpoint value.
- below **C** Abort the profile and remain in Profiler Mode with the Control outputs off.

Figure 57. Profile Abort Action



Note: When using two loop profiles, the abort-action applies to both loops, but each ends with its own individual setpoint in line with the method chosen.

17 USB Interface

The features in this section are available on models fitted with the optional USB Interface.

Using the USB Port

The USB Interface can be used to upload or download instrument settings to or from a USB memory stick. Easy configuration of multiple instruments is achieved by copying from one instrument to another, or by transferring data from the PC configuration software. If the Data Recorder or Profiler options are fitted, recordings and profile information can also be transferred via USB memory stick. *Refer also to the USB menu on page 60.*

USB Memory Stick Folders & Files

When a USB stick is inserted, the instrument looks for, and if necessary creates the **DEVICE**, **CONFIG**, **PROFILE** and **RECORDER** folders. Files must be located in these folders in order to be used by the instrument. When preparing to upload files from your PC, ensure that you save them to the correct folder on the memory stick.



CAUTION: If the file name already exists, data will be overwritten.

DEVICE – This folder must be located in the Root of the USB memory stick

CONFIG – Configuration files (*.bct)

PROFILE – Profile program files (*.pfl)

RECORDER – Recorder log folders/files The user is asked for a new recorder sub-folder name before transferring recorder data to USB. The instrument stores the log files (*.csv) in this folder.



Note: To speed up the disk operation, keep the number of files in these folders to a minimum.

The first recorder log file is named 001-0001.csv. A new file is created with the first 3 digits incremented (e.g. **002**-0001.csv; **003**-0001.csv etc) each time the data being recorded is changed. The last 4 digits increment (e.g. 001-**0002**.csv; 001-**0003**.csv etc) if the file size reaches 65535 lines, or if recording is re-started after being stopped for >2x the recording sample rate.



CAUTION: Do not remove the memory stick during data transfer. Data corruption may result.



CAUTION: During data transfer, normal operations carry on in the background, but operator access is denied. Transfer of full memory can take up to 20 minutes. Only begin a transfer when access to the instrument (e.g. setpoint changes) will not be required.

18 Data Recorder

The optional Data Recorder allows the recording of process conditions to memory over time. It operates independently from the Trend Views. The recorder includes 1Mb of flash memory to store data when powered down and a real time clock (RTC) with a battery backup.



CAUTION: Servicing of the Data Recorder/RTC circuit and replacement of the internal lithium battery should be carried out by only a trained technician.

Recordable Values

A selection of values can be recorded for each control loop, from: Process Variable; Maximum or Minimum Process Values (since the previous sample); Setpoints; Primary Power, Secondary Power or Auxiliary Input values. Additionally the status of Alarms and Profiler Events can be recorded, as can when the unit is turned On/Off. See *the Recorder Configuration sub-menu on page 58*.

Sampling rates between 1 second and 30 minutes are possible, with the data either recorded until all memory is used, or with a continuous “First In/First Out” buffer overwriting the oldest data when full.

The recording capacity is dependent on sample rate and number of values recorded. For example: Two analogue values will be recorded for 21 days at 30s intervals. More values or faster sample rates reduce the duration proportionally.



Note: If Alarm or Events are selected, their change of state is recorded using extra memory. If the alarm status is likely to change often, take this into account when determining if there is sufficient memory available.

Recorder Control and Status

Options for starting/stopping recordings include **Manually** (from the recorder menu or a screen added to operation mode); a **Digital Input**; during a **Running Profile**; or **Record on Alarm**. See *the Recorder Configuration sub-menu on page 58*.

The recorder control menu (*page 62*) allows the manual trigger to be started or stopped, as well as deleting recorded data from memory.

A status screen is shown with current information about the recorder, including if a recording is in progress (Recording or Stopped); the recording mode (FIFO or Record Until Memory Is Used); a % memory use bar-graph and the estimated available time remaining based on the data selected and memory used.



Manual Record



Digital Input



Profile Record



Alarm Record

These icons are displayed for each active recording trigger.

Recorder status and manual record trigger control can optionally be added to Operation Mode. This is enabled or disabled in the Display Configuration sub-menu on page 59.



Note: The recorder control screens allow the manual trigger to be started or stopped, but recording will continue as long as any trigger that has been configured is active.

Uploading Data

Recordings can be transferred to a memory stick using the USB Port (See page 96). They can also be uploaded directly to the PC software via the configuration port or RS485/Ethernet communications if fitted.

	A	B	C	D	E	F	G
1	SerialNumber=00724406-003-010						
2	FileDate=06.08.2013 09:41:09						
3	Date(en)	Time	PV1	Alarm 1 St:	Alarm 2 St:	Alarm 3 St:	Alarm 4
4	01/08/2013	18:33:40	199.76	0	0	0	
5	01/08/2013	18:33:52	199.8	0	0	0	
6	01/08/2013	18:34:14	199.84	0	0	0	
7	01/08/2013	18:34:24	199.88	0	0	0	
8	01/08/2013	18:34:34	199.92	0	0	0	
9	01/08/2013	18:34:44	199.96	0	0	0	
10	01/08/2013	18:34:54	200	0	0	0	
11	01/08/2013	18:35:04	200.04	0	1	0	
12	01/08/2013	18:35:14	200.08	0	1	0	
13	01/08/2013	18:35:24	200.12	0	1	0	
14	01/08/2013	18:35:34	200.16	0	1	0	
15	01/08/2013	18:35:44	200.2	0	1	0	
16	01/08/2013	18:35:54	200.24	0	1	0	
17	01/08/2013	18:35:58	200.28	0	1	0	
18	01/08/2013	18:36:08	200.32	0	1	0	
19	01/08/2013	18:36:18	200.36	0	1	0	
20	01/08/2013	18:36:28	200.4	0	1	0	
21	01/08/2013	18:36:38	200.44	0	1	0	

The data is stored in Comma Separated format (.csv) which can be opened and analysed with the optional PC software or opened directly into a spreadsheet. Many third party software programs can also import data in the .csv format.

The file contains a header identifying the source instruments serial number, the date of the file upload and descriptions of the data columns.

The data columns seen depends on the data selected to record, but will always include the date and time of each sample. The date format follows the instrument date format selection. Date(en) is dd/mm/yyyy, and Date (us) is mm/dd/yyyy.



Note: Analysis with the PC software is limited to 8 analogue channels, so only the first 8 will be displayed. The number of recorded alarms & events is not limited.

Additional Features & Benefits from the Recorder

The real time clock (RTC) included with the data recorder also expands the profiling capabilities (see Profiler on page 87) and allows a “calibration due” reminder to be shown at a specified date (see the Input Configuration sub-menu on page 46).

19 Controller Tuning

PID Sets & Gain Scheduling

Up to 5 sets of PID tuning terms can be entered for each control loop, allowing the instrument to be pre-set for differing conditions. Each set has individual values for the following parameters: Primary Proportional Band; Secondary Proportional Band; On-Off Differential; Integral Time; Derivative time; Overlap/Deadband.

The parameter values can be entered in the control configuration sub menu (*page 50*), but also see Automatic Tuning below for automatic tuning of the PID sets.

The PID sets might be configured for different applications, or to allow for differing process or load conditions that might occur in a single application. In this case one set at a time would be selected as the “Active PID” set for that loop.

Alternatively, if the process conditions change significantly during use (e.g. if it is partially exothermic as the temperature rises) Gain Scheduling can be employed.

Gain scheduling ‘bumplessly’ switches PID sets automatically at successively higher setpoint or process values, giving optimal control across a wide range of process conditions. This is explained in the diagram below.

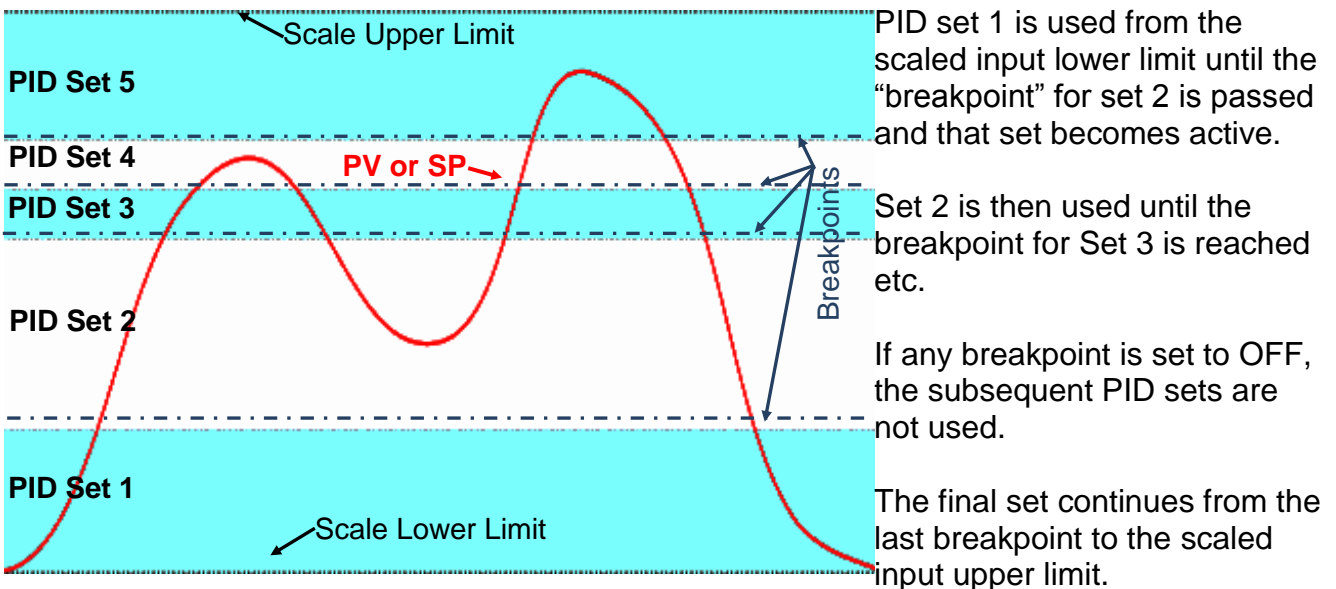

Gain Scheduling breakpoints can be selected to switch PID sets with a change in the current setpoint value, or the current process value.



Note: *ON/OFF control is possible with the individual PID sets but cannot be used with gain scheduling. On/off control is replaced with the default proportional band if gain scheduling is turned on.*

If there is a change to the scale lower or upper limits forces any of the breakpoints out of bounds, all breakpoints will be turned off and the instrument uses the default PID set 1.

Automatic Tuning

To automatically optimise the controllers tuning terms for the process, you can use Pre-Tune, Self-Tune or Auto Pre-Tune independently for each control loop.



Note: *Automatic tuning will not engage if either proportional band is set to On/Off control. Also, pre-tune (including an auto pre-tune attempt) will not engage if the setpoint is ramping, if a profile is running, or if the Process Variable is <5% of span from setpoint.*

Pre-Tune

Pre-tune performs a single disturbance of the normal start-up pattern so that a good approximation of the ideal PID values can be made prior reaching setpoint. It automatically stops running when the test is complete. The user chooses which PID set the new tuning terms will be applied to, but this selection does not change the selected “active PID set”. This allows tuning of any PID set for future use before return to control with the current PID set. In VMD mode, derivative is not applied by pre-tune, and the controller is optimised for PI control. In standard control mode, PI & D are all calculated, which may not suit all processes.

There are two pre-tune modes with different process test points. The first is “Standard Pre-Tune” which tests the process response half-way from the activation point (the process value when pre-tune began running) to the current setpoint. The second type is “Pre-Tune at Value” which allows the user to specify the exact point at which the process test will occur.



CAUTION: Consider possible process over-shoot when selecting the value to tune at. If there is a risk of damage to the product or equipment select a safe value.

During pre-tune, the controller outputs full primary power until the process reaches the specified test point. Power is then removed (full secondary power applied for dual control), causing an oscillation which the pre-tune algorithm uses to calculate the proportional band(s), integral and derivative time. The pre-tune process is shown below.

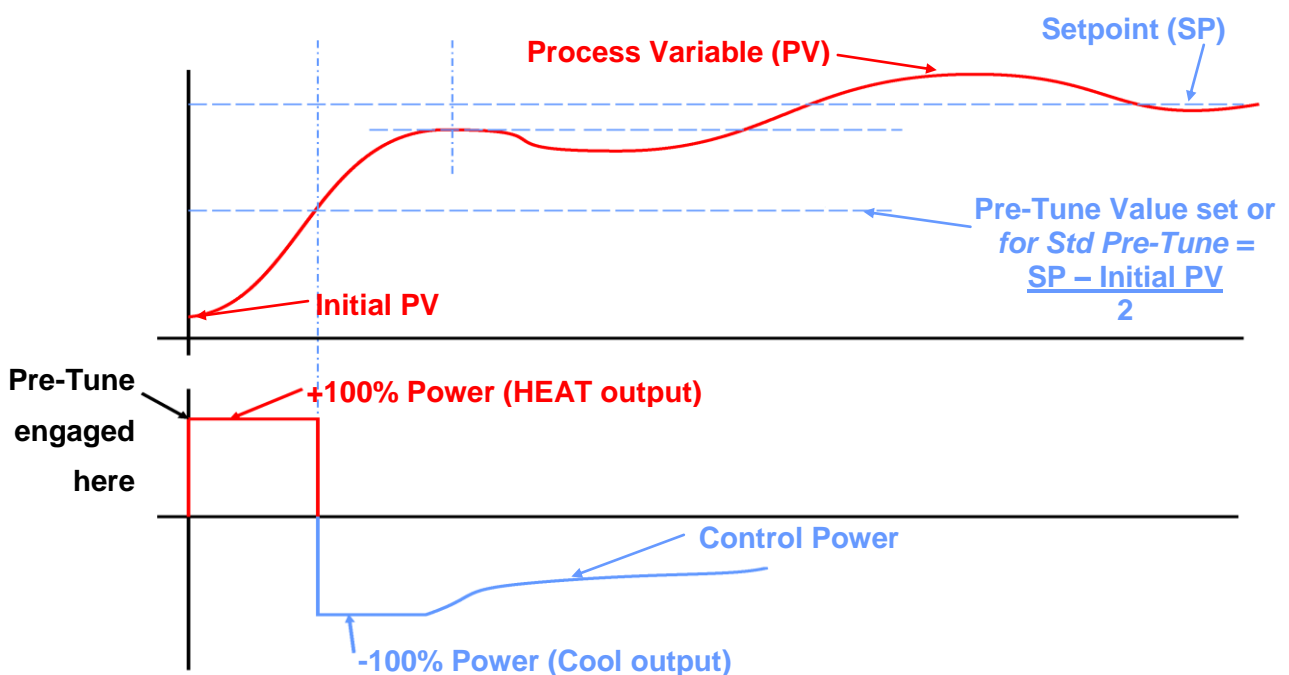

Figure 58. Pre-Tune Operation

Pre-tune is selected from the automatic tuning menu. It will not engage if either primary or secondary outputs on a controller are set for On-Off control, during setpoint/profile ramping or if the process variable is less than 5% of the input span from the setpoint.



Note: To pre-tune a cascade, first select “Cascade-Open” to tune the PID set(s) on the slave. After the slave has successfully tuned, remember to pre-tune the master/slave combination (this time select “Cascade-Closed”). The cascade remains open until you do this.

Auto Pre-Tune

As a single-shot operation, pre-tune will automatically disengage once complete, but can be configured to run at every power up using the auto pre-tune function. If auto pre-tune is selected, a Standard Pre-tune will attempt to run at every power up, applying new tuning terms to the current Active PID set. Auto pre-tune will not be able to test the process if at the time the controller is powered up, either primary or secondary outputs are set for On-Off control, during setpoint/profile ramping or if the process variable is less than 5% of the input span from the setpoint. Auto pre-tune is not possible with cascade control mode.

Self-Tune

If engaged, self-tune uses a pattern recognition algorithm to continuously monitor and adjust for control deviation. It optimises the tuning by applying new PID terms to the current Active PID set while the controller is operating. In VMD control mode, derivative is not applied by self-tune, and the controller is optimised for PI control.

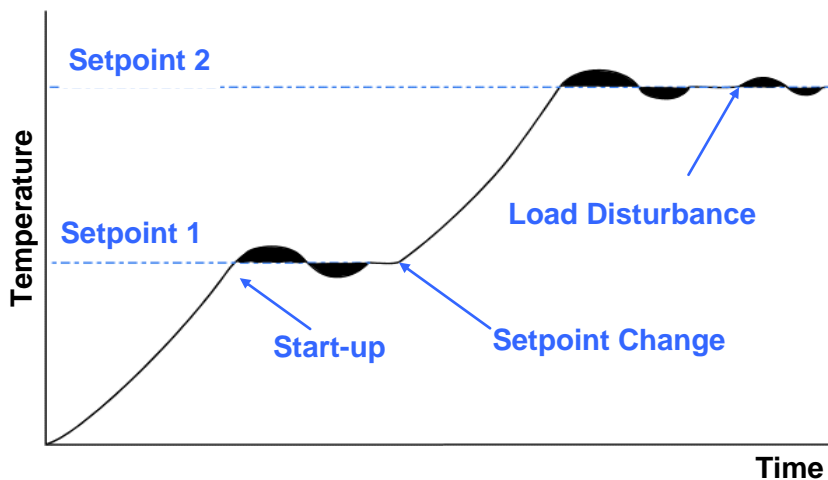

Figure 59. Self-Tune Operation

The diagram shows a typical application involving a process start up, setpoint change and load disturbance. In each case, self-tune observes one complete oscillation before calculating new terms. Successive deviations cause the values to be recalculated converging towards optimal control. When the controller is switched off, these terms are stored and used as starting values at switch on. The stored values may not always be ideal, if for instance the controller is new or the application has changed. In this case the user can use pre-tune to establish new initial values for self-tune to fine-tune.

Use of continuous self-tuning is not always appropriate. For example frequent artificial load disturbances, such as where an oven door is often left open for extended periods, might lead to calculation errors. In standard control mode, PI & D are all calculated, which may not suit all processes. Self-Tune cannot be engaged if the instrument is set for on-off control or with cascade control mode.

Manually Tuning

Tuning Control Loops - PID with Primary Output only

This technique balances the need to reach setpoint quickly, with the desire to limit setpoint overshoot at start-up or during process changes. It determines values for the primary proportional band and the integral and derivative time constants that allow the controller to give acceptable results in most applications that use a single control device.



CAUTION: This technique is suitable only for processes that are not harmed by large fluctuations in the process variable.

1. Check that the scaled input limits and the setpoint limits are set to safe and appropriate levels for your process. Adjust if required.
2. Set the setpoint to the normal operating value for the process (or to a lower value if an overshoot beyond this value might cause damage).
3. Select On-Off control (i.e. set the primary proportional band to zero).
4. Switch on the process. The process variable will rise above and then oscillate about the setpoint. Record the peak-to-peak variation (**P**) of the first cycle (i.e. the difference between the highest value of the first overshoot and the lowest value of the first undershoot), and the time period of the oscillation (**T**) in minutes. See the diagram below.
5. Calculate the PID control parameters (primary proportional band, integral time and derivative time) using the formulas shown.
6. Repeat steps 1-5 for the second control loop if required

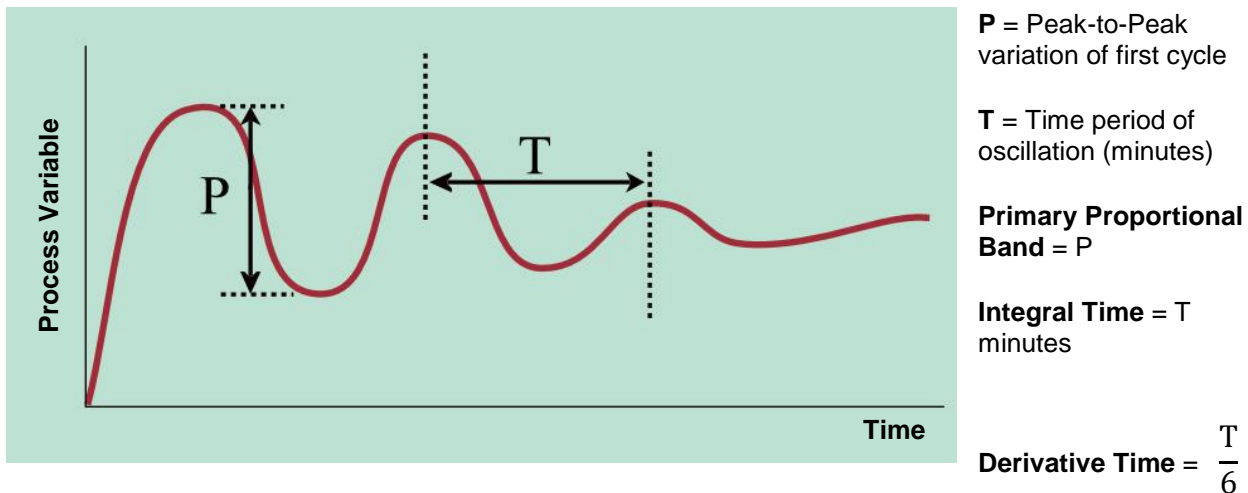

Figure 60. Manually Tuning - PID with Primary Output

Tuning Control Loops - PID with Primary & Secondary Outputs

This tuning technique balances the need to reach setpoint quickly, with the desire to limit setpoint overshoot at start-up and during process changes. It determines values for the primary & secondary proportional bands, and the integral and derivative time constants that allow the controller to give acceptable results in most applications using dual control (e.g. Heat & Cool).



CAUTION: These techniques are suitable only for processes that are not harmed by large fluctuations in the process variable.

Method 1 – For Simple Processes

Use this method if the process is simple/easily controlled and the relative power available from the primary and secondary actuators is approximately symmetrical (e.g. if the maximum heating and cooling power is equal)

1. Tune the controller using only the Primary Control output as described in steps 1 to 5 of Manually Tuning - PID with Primary Output, above.
2. Set the Secondary Proportional Band to the same value as the Primary Proportional Band and monitor the operation of the controller in dual control mode.
3. If there is a tendency to oscillate as the control passes into the Secondary Proportional Band, increase its value. If the process appears to be over-damped (slow to respond) in the region of the secondary proportional band, decrease its value.
4. When the PID tuning values have been determined, if there is a disturbance to the process variable as control passes from one proportional band to the other, set the Overlap/Deadband parameter to a positive value to introduce some overlap. Adjust this value by trial and error until satisfactory results are obtained.

Method 2 – For Asymmetrical Processes

Use this method if the relative power available from the primary and secondary actuators is not symmetrical (e.g. if the maximum cooling power is less than the maximum heating power)

1. Check that the scaled input limits and the setpoint limits of the loop in question are set to safe and appropriate levels for your process. Adjust if required.
2. Set the setpoint to the normal operating value for the process (or to a lower value if overshoots beyond this value might cause damage).
3. Select On-Off control by setting the primary proportional band to zero (the secondary proportional band will automatically be set on-off control when you do this).
4. Switch on the process. The process variable will oscillate about the setpoint. Record the peak-to-peak variation (**V**) of the oscillation (i.e. the difference between the on-going overshoot and undershoot), the time period of the oscillation (**T**) in minutes and the maximum rate of rise (**dP**) and fall (**dS**) as the oscillation continues.

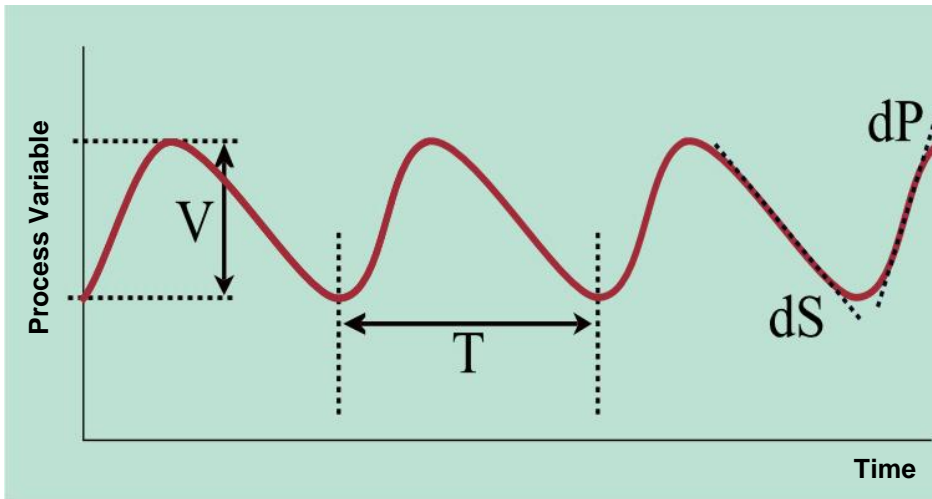

V = On-going Peak-to-Peak variation

T = Time period of oscillation (minutes)

dS = Maximum rate of rise

dP = Maximum rate of fall

R = Ratio $\frac{dS}{dP}$

Primary proportional band = $Pb.P = \frac{V}{R}$

Secondary proportional band = $R \times Pb.P$

Integral Time = T minutes **Derivative Time** = $\frac{T}{6}$

5. Calculate and enter the PID control parameters (primary proportional band, integral time and derivative time) using the formulas shown, and observe the process.
6. If symmetrical oscillation occurs, increase the proportional bands together, maintaining the same ratio. If the asymmetrical oscillation occurs, adjust the ratio between the bands until it becomes symmetrical, then increase the bands together, maintaining the new ratio.
7. When the PID tuning values have been determined, if there is a disturbance to the process variable as control passes from one proportional band to the other, set the Overlap/Deadband parameter to a small positive value to introduce some overlap. Adjust this value by trial and error to find the minimum value that gives satisfactory results.

Valve, Damper & Speed Controller Tuning

This tuning method is used when controlling devices such as dampers, modulating valves or motor speed controllers. It applies equally to modulating valves with their own valve positioning circuitry, or in VMD mode where the instrument directly controls the valve motor—see *Valve Motor Drive / 3-Point Stepping Control on page 14*. It determines values for the primary proportional band, and integral time constant. The derivative time is normally set to **OFF**. This type of PI Control minimises valve/motor wear whilst giving optimal process control.

In VMD mode the Motor Travel Time and Minimum On Time must be correctly set to match the valve specifications before attempting to tune the controller.



CAUTION: This technique is suitable only for processes that are not harmed by large fluctuations in the process variable.

1. Set the setpoint to the normal operating process value (or to a lower value if overshoot beyond this value is likely to cause damage).
2. Set the Primary Proportional Band a value approximately equal to 0.5% of the input span for the loop to be tuned. (*Span is the difference between the scaled input limits*).
3. Set the Integral & Derivative time constants both to OFF.
4. Switch on the process. The process variable should oscillate about the setpoint.

5. Follow the instructions in the diagram below. At each stage, allow sufficient settling time before moving on to the next stage. **P.Pb** is the Primary Proportional Band, **Int.T** is the Integral Time Constant.

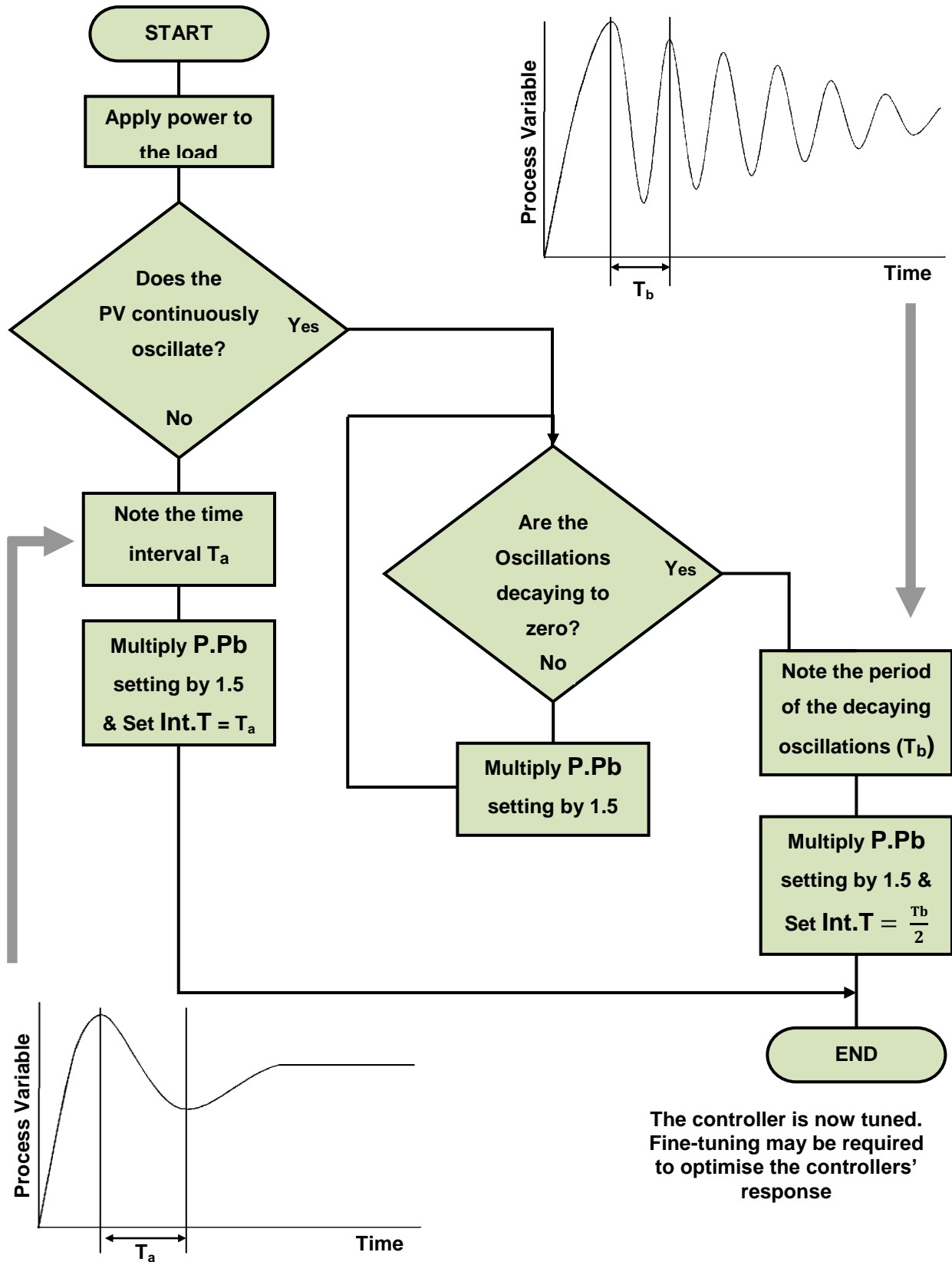

This method can also be used to tune PID loops. Set Derivative to approx. $T_a / 4$

Figure 61. Manually Tuning – PI Control

Fine Tuning

Small adjustments can be made to correct minor control problems. These examples assume reverse acting control (e.g. heating). Adjust accordingly for direct action. If they do not help solve the problem, re-tune the controller as detailed on the preceding sections.



Note: *When fine tuning the settings, only adjust one parameter at a time, and allow enough time for the process to settle into its new state each time you change a value.*

Cycle Times

A separate cycle time adjustment parameter is provided for the Primary and Secondary control when using time-proportioning control outputs.

If the process oscillates at the same frequency as the cycle time, it indicates it may be too long for the process. Decrease the cycle time and re-check the period of oscillation, if it has changed to match the new cycle time this confirms that the time is too long.

If the control actuators will accept it, continue reducing the cycle time until the process stabilises, or no further improvement is seen.

Recommended times. Relays ≥ 10 seconds. SSR Driver 1 second.

Proportional Cycle Times

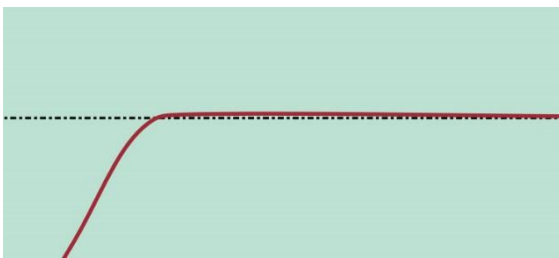

Ideal: Stable Process

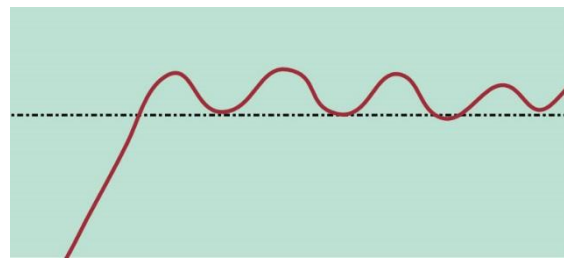

Too Long: Oscillation period = cycle time.



Note: *Adjusting the cycle time affects the controllers operation; a shorter cycle time gives more accurate control, but mechanical control actuators such as relays will have a reduced life span.*

Proportional Bands

Increase the width of the proportional bands if the process overshoots or oscillates excessively. Decrease the width of the proportional band if the process responds slowly or fails to reach setpoint.

Proportional Bands

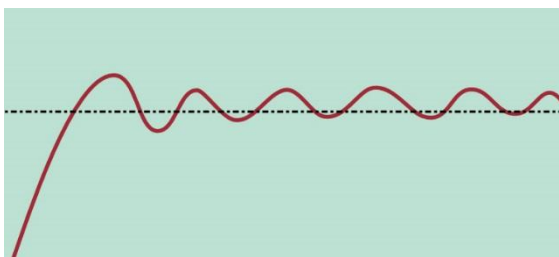

Too Narrow: Process Oscillates

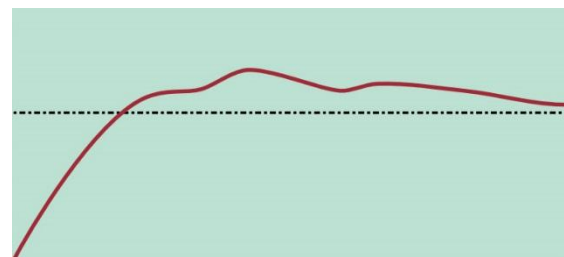

Too Wide: Slow warm up and response

Integral Time Constant

To find the optimum integral time, decrease its value until the process becomes unstable, then increase it a little at a time, until stability has been restored. Induce a load disturbance or make a setpoint change to verify that the process stabilises. If not increase the value some more and re-test. If the response is too slow, decrease the integral time, but avoid instability.

Integral Time

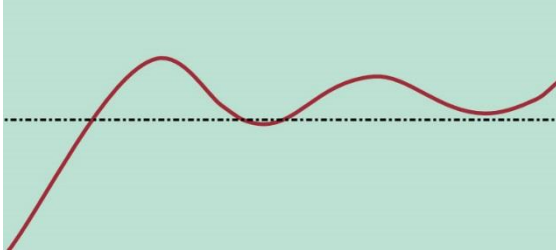

Too Short: Overshoots and oscillates

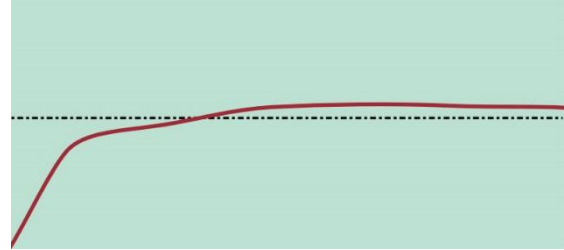

Too Long: Slow warm up and response

Derivative Time Constant

Initially set the derivative to between 1/4th and 1/10th of the Integral time value. Increase the derivative time if the process overshoots/undershoots. Increase it a little at a time, but if the process becomes unstable, decrease it until the oscillation stops. Induce a load disturbance or make a setpoint change to verify that the process stabilises. If not decrease the value some more and re-test.

Derivative Time

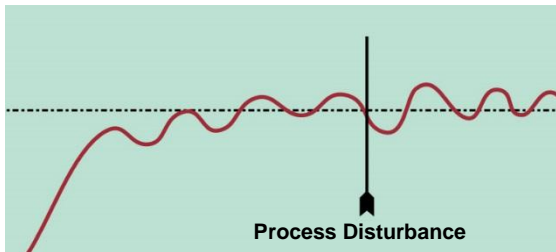

Too Long: Oscillates and over corrects when process disturbed

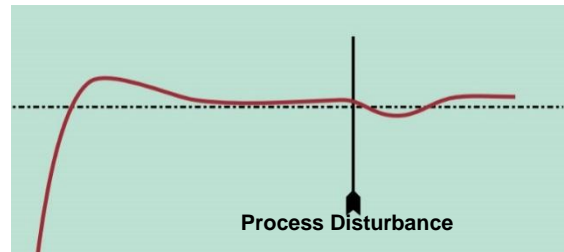

Too Short: Slow warm up and disturbance response under-corrects



Note: *When controlling a modulating valve, it is usually recommended that derivative is set to OFF to avoid excessive valve activity. Derivative can cause process instability in these processes.*

Anti Wind-up

If after fully optimising the tuning, there is an overshoot of the setpoint at start-up or in response to large setpoint changes, the reset wind-up inhibit point can be reduced to suspend integral action until the process is closer to setpoint. If set too low control deviation can occur (the process settles, but is offset above or below the setpoint). If this is observed, increase the value until the deviation error is removed.

Anti Wind-up



Too Small: Overshoots setpoint before settling

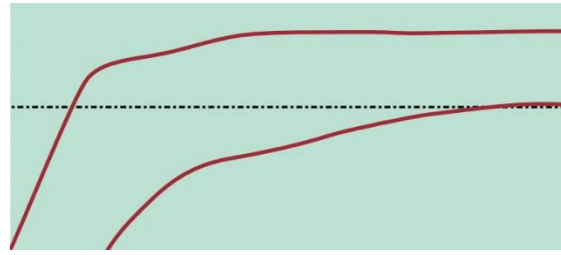

Too Short: Slow to setpoint or offset above/below setpoint

Manual Reset

For proportional only control, after making all other adjustments, if a positive control deviation error exists (process is offset above the setpoint) reduce the manual reset until the error is eliminated. If there is a negative error (process is offset below the setpoint) increase manual reset until the error is eliminated.

For PID or PI control, typically set manual reset to approximately 80% of power needed to maintain setpoint, but lower values can be used to inhibit start-up overshoot if required.

Manual Reset



Too High: Overshoots setpoint at start-up

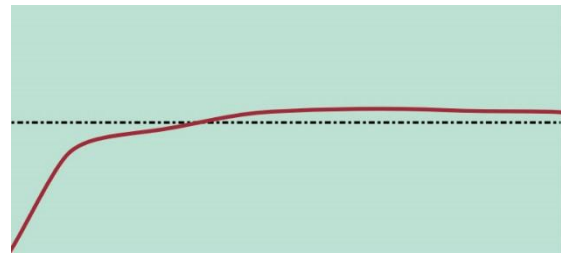

Too Low: Slow to setpoint

20 Serial Communications

Supported Protocols

Communication with a Modbus RTU or Modbus TCP master device is possible if the appropriate communications module is fitted in option slot A. An RS485 Module is required for Modbus RTU. An Ethernet Module is required for Modbus TCP. The instrument can also act as “setpoint master” over RS485 for multi-zone applications. In this mode the unit continuously sends its setpoint value using Modbus broadcast messages. Master mode is not available with Ethernet module.

To protect the EEPROM from excessive write operations, the 6 most recent parameter write requests are held in standard RAM. All data is written to EEPROM at power-down or if another parameter is changed. Avoid continuously changing more than 6 parameters.

All models also have a configuration socket for bench setup via the PC configuration software prior to installation. An RS232 to TTL lead (*available from your supplier*) is required in order to use this socket. A front mounted USB port is available on some models; this can also be used to configure the instrument or to transfer recorder or profile files via a USB memory stick.

RS485 Configuration

The RS485 address, bit rate and character format are configured via the front panel from the Comms Configuration sub-menu or by using the PC Configurator software.

Data rate:	4800, 9600, 19200, 38400, 57600 or 115200 bps
Parity:	None (default), Even, Odd
Character format:	Always 8 bits per character.
Device Address:	<i>See below.</i>

RS485 Device Addressing

The instrument must be assigned a unique device address in the range 1 to 255. This address is used to recognise Modbus queries intended for this instrument. With the exception of globally addressed broadcast messages, the instrument ignores Modbus queries that do not match the address that has been assigned to it.

The instrument will accept broadcast messages (global queries) using device address 0 no matter what device address is assigned to it. No response messages are returned for globally addressed queries.

Ethernet Configuration

For Modbus TCP communications (Modbus over Ethernet), the Ethernet IP address can either be assigned by a Dynamic Host Configuration Protocol (DHCP), BootP or AutoIP server on the network, or manually assigned using the IP address allocation software tool. Refer to the PC Software section of this manual on page 235 for more information about setting the IP address.

The supported data rates 10/100BASE-T (10 or 100 Mbps) are automatically detected.

Link Layer

A query (data request or command) is transmitted from the Modbus Master to the Modbus Slave. The slave instrument assembles the reply to the master. This instrument is normally a slave device. It can only act as a master when being use as setpoint master controller to broadcast its setpoint to other controllers in a multi-zone application.

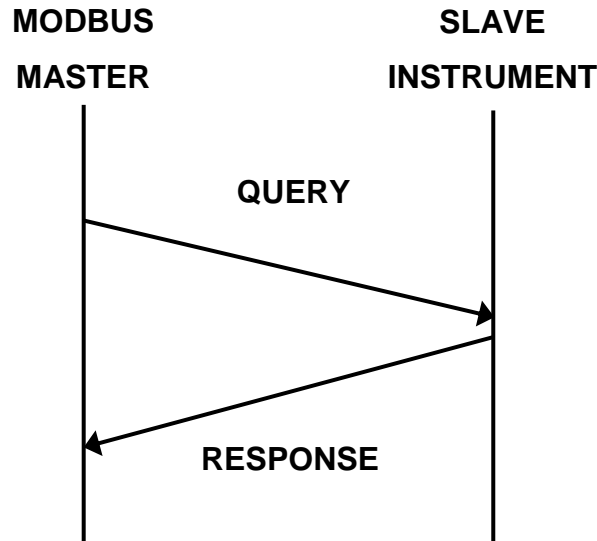

Figure 62. Modbus Link Layer

A message for either a QUERY or RESPONSE is made up of an inter-message gap followed by a sequence of data characters. The inter-message gap is at least 3.5 data character times - the transmitter must not start transmission until 3 character times have elapsed since reception of the last character in a message, and must release the transmission line within 3 character times of the last character in a message.



Note: *Three character times is approximately 0.25ms at 115200 bps, 0.51ms at 57600 bps, 0.75ms at 38400 bps, 1.5ms at 19200 bps, 3ms at 9600 bps and 6ms at 4800bps.*

Data is encoded for each character as binary data, transmitted LSB first.

For a QUERY the address field contains the address of the slave destination. The slave address is given together with the Function and Data fields by the Application layer. The CRC is generated from the address, function and data characters.

For a RESPONSE the address field contains the address of the responding slave. The Function and Data fields are generated by the slave application. The CRC is generated from the address, function and data characters.

The standard MODBUS RTU CRC-16 calculation employing the polynomial $2^{16}+2^{15}+2^2+1$ is used.

Inter-message gap	Address 1 character	Function 1 character	Data <i>n</i> characters	CRC Check 2 characters
-------------------	------------------------	-------------------------	-----------------------------	---------------------------

Supported Modbus Functions

The following Modbus function types are supported by this instrument:

Function Code	Modbus Meaning	Description
03 / 04	Read Holding/Input registers	Read current binary value of specified number of parameters at given address. Up to 64 parameters can be accessed with one query.
06	Write Single Register	Writes two bytes to a specified word address.
08	Diagnostics	Used for loopback test only.
16 (0x10 hex)	Write Multiple Registers	Writes up to 253 bytes of data to the specified address range.
23 (0x17 hex)	Read/Write Multiple Registers	Reads and Writes 253 bytes of data to the specified address ranges.

Function Descriptions

The following is interpreted from the Modbus protocol description obtainable from www.modbus.org. Refer to that document if clarification is required. In the function descriptions below, the preceding device address value is assumed, as is the correctly formed two-byte CRC value at the end of the QUERY and RESPONSE frames.

Function 03 / 04 - Read Holding/Input Registers

Reads current binary value of data at the specified word addresses.

QUERY: Function 03 / 04 - Read Holding/Input Registers				
Func Code	Address of 1 st Word		Number of Words	
03/04	LO	LO	HI	LO

RESPONSE: Function 03 / 04 - Read Holding/Input Registers						
Func Code	Byte Count	1 st Word		etc	Last Word	
03/04	xx	HI	LO	→	HI	LO



Note: In the response the "Number of Bytes" indicates the number of data bytes read from the instrument. E.g. if 5 words are read, the count will be 10 (0xA hex). The maximum number of words that can be read is 64. If a parameter does not exist at one of the addresses read, a value of 0000h is returned for that word.

Function 06 - Write Single Register

Writes two bytes to a specified word address.

QUERY: Function 06 - Write Single Register				
Func Code	Address of Word		Value to write	
06	HI	LO	HI	LO

RESPONSE: Function 06 - Write Single Register				
Func Code	Address of Word		Value Written	
06	HI	LO	HI	LO



Note: The Response normally returns the same data as the query.

Function 08 - Loopback Diagnostic Test

QUERY: Function 08 - Loopback Diagnostic Test				
Func Code	Diagnostic Code		Value	
08	00	00	HI	LO

RESPONSE: Function 08 - Loopback Diagnostic Test				
Func Code	Sub-function		Value	
08	00	00	HI	LO



Note: The Response normally returns the same data as the loopback query. Other diagnostic codes are not supported.

Function 16 - Write Multiple Registers (0x10 Hex)

Writes consecutive word (two-byte) values starting at the specified address.

QUERY: Function 16 - Write Multiple Registers (0x10 Hex)										
Func Code	1 st Write Address		Number of Words		Byte Count	1st Word		etc	Last Word	
10	HI	LO	HI	LO	xx	HI	LO	→	HI	LO

RESPONSE: Function 16 - Write Multiple Registers (0x10 Hex)				
Func Code	1st Word Address		Number of Words	
10	HI	LO	HI	LO



Note: The maximum number of data bytes that can be written in one message is 253 bytes.

Function 23 Hex - Read / Write Multiple Registers (0x17 hex)

Reads and writes the requested number of consecutive words (two-bytes) starting at the specified addresses.

QUERY: Function 23 Hex - Read / Write Multiple Registers (0x17 hex)														
Func Code	1 st Read Address		Number of Words		1 st Write Address		Number of Write Words		Byte Count	Values to Write				
	HI	LO	HI	LO	HI	LO	HI	LO		1st Word	etc	Last Word		
17	HI	LO	HI	LO	HI	LO	HI	LO	xx	HI	LO	→	HI	LO

RESPONSE: Function 23 Hex - Read / Write Multiple Registers (0x17 hex)						
Func Code	Byte Count	Read Data				
		1st Word	etc	Last Word		
17	xx	HI	LO	→	HI	LO



Note: The maximum number of data bytes that can be read and written in one message is 253 bytes.

Exception Responses

If a QUERY is sent without a communication error, but the instrument cannot interpret it, an Exception RESPONSE is returned. The exception response consists of a modified version of the original function code and an exception code that explains what was wrong with the message. Possible exception responses and their reasons are:

Function Code	Exception Code	Modbus Meaning	Description
The original function code with its most significant bit (MSB) set. <i>This offsets it by 0x80, so for example 0x06 becomes 0x86.</i>	00	Unused	None.
	01	Illegal function	Function number is out of range.
	02	Illegal Data Address	Write functions: Parameter number is out of range or not supported. <i>(for write functions only).</i> Read Functions: Start parameter does not exist or the end parameter greater than 65536.
	03	Illegal Data Value	Attempt to write invalid data / required action not executed.



Note: *In the case of multiple exception codes for a single query, the Exception code returned is the one corresponding to the first parameter in error.*

Modbus Parameters

The register addresses for the Modbus parameters are detailed in the tables below. The Access column indicates if a parameter is read only (RO) or if it can also be written to (RW). Communications writes will not be implemented if the Writing Via Serial Comms



Note: *Read only parameters will return an exception if an attempt is made to write values to them.*

Some parameters that do not apply for a particular configuration will still accept read / writes (e.g. attempting to scale a linear output which has not been fitted).

parameter in the Communications Configuration sub-menu is set to Disabled.

Data Formats

Data can be accessed in three formats: **Integer Only** (decimal places are not included), **Integer with 1 Decimal Place** (only the first decimal place value is included) or an IEEE / Motorola (big endian) **Floating Point Number**. Where possible use floating point numbers especially if the values have more than one decimal place.

Parameter Register Address Listings

Calculating Parameter Register Addresses				
		Integer Only	Integer+1	Floating Point
Register Address Calculation	(hex)	Address	Address + 0x4000	Address x 2 + 0x8000
	(dec)	Address	Address + 16384	Address x 2 + 32768
Address Example: (For Loop 1 Process Variable)	(hex)	0x0407	0x4407	0x880E
	(dec)	1031	17415	34830
Data Value Returned: If actual Value = 23.9 decimal	(hex)	0x00, 0x17	0x00, 0xEF	0x41, 0xBF, 0x33, 0x33
	(dec)	23	239	23.9 as floating decimal

The register address offset calculations are shown above.

For your convenience, the parameter tables on the following pages show each parameter's Modbus register address as a decimal and hexadecimal number for all three formats. The tables also show if the parameter has read-only (RO) or read-write (RW) access.

Analogue parameter values and their limits are expressed as decimals.

Bit parameters list the bit positions and their meaning (bit 0 = LSB). Only bits that have a function are listed, unused bits are omitted.

Calibration Reminder Parameters

Parameter Name & Register Address						
	Integer	Int +1	Float	Access	Values	& Descriptions
Calibration Reminder Enable					Value	Calibration Reminder Status
Dec	1048	17432	34864	RW	0	Disabled
Hex	0418	4418	8830		1	Enabled
Calibration Reminder Date					Value	Calibration Status
Dec	n/a	n/a	34866	RW	This can be entered only as a floating point number. When converted to binary the least significant 19 bits represents the date in this format:	
Hex	n/a	n/a	8832		<p style="text-align: center;"> www DDDDD MMMM YYYYYY YYYYYYY = YEAR MMMM = MONTH DDDDD = DAY OF MONTH (1-31 but must be valid) www = Day of the week The day of week portion is calculated from the date (<i>Read Only</i>). </p> <p>Example with date set to 31/07/2012</p> <p>Day (31) = 11111</p> <p>Month (7) = 0111</p> <p>Year (12) = 0001100</p> <p>Bits 17 and higher are ignored when writing so 11111 0111 0001100 (64396 decimal) is just one of many possible numbers to write as 31/07/2012, and when reading the date back, the number returned is 10 11111 0111 0001100 (195468 decimal) because bits 17-19 are 010 (to represent "Tuesday").</p>	

Universal Process Input 1 Parameters

Parameter Name & Register Address						
	Integer	Int +1	Float	Access	Values	& Descriptions
Universal Process Input 1 Type					Value	Process Input Type
Dec	1024	17408	34816	RW	0	B Type Thermocouple
Hex	0400	4400	8800		2	C Type Thermocouple
					4	D Type Thermocouple
					6	E Type Thermocouple
					8	J Type Thermocouple
					10	K Type Thermocouple
					12	L Type Thermocouple
					14	N Type Thermocouple
					16	R Type Thermocouple
					18	S Type Thermocouple
					20	T Type Thermocouple
					22	PtRh 20%: 40% Thermocouple
					24	PT100 RTD
				26	NI120 RTD	
				28	0 to 20mA DC	
				29	4 to 20mA DC	
				30	0 to 50mV DC	

					31	10 to 50mV DC
					32	0 to 5V DC
					33	1 to 5V DC
					34	0 to 10V DC
					35	2 to 10V DC
					36	Potentiometer
Input 1 Engineering Units				Value	Engineering Units For Display	
Dec	1025	17409	34818	RW	0	= None
Hex	0401	4401	8802		1	= °C (Default for Europe)
					2	= °F (Default for USA)
					3	= °K
					4	= Bar
					5	= pH
					6	= %
					7	= %RH
					8	= PSI
Input 1 Maximum Display Decimal Places				Value	Maximum Number Of Decimal Places In Display	
Dec	1026	17410	34820	RW	0	None (e.g. 1234)
Hex	0402	4402	8804		1	One (e.g. 123.4)
					2	Two (e.g. 12.34)
					3	Three (e.g. 1.234)
Input 1 Scaled Input Lower Limit				Scaling Value Low Limit		
Dec	1027	17411	34822	RW	Valid between input 1 range maximum and minimum (see <i>Specifications section for input details</i>)	
Hex	0403	4403	8806			
Input 1 Scaled Input Upper Limit				Scaling Value High Limit		
Dec	1028	17412	34824	RW	Valid between input 1 range maximum and minimum (see <i>Specifications section for input details</i>)	
Hex	0404	4404	8808			
Input 1 Process Variable Offset				Single Point Calibration PV Offset		
Dec	1029	17413	34826	RW	Used for Single Point Calibration of input 1 Valid between the scaled input lower & upper limits	
Hex	0405	4405	880A			
Input 1 Filter Time Constant				Input 1 Process Input Filter Time		
Dec	1030	17414	34828	RW	Valid between 0.0 and 512.0	
Hex	0406	4406	880C			
Input 1 Process Variable				Process Input 1 Value		
Dec	1031	17415	34830	RO	The current input 1 process value	
Hex	0407	4407	880E			
Input 1 Signal /Sensor Break Flag				Value	Process Input Break Status	
Dec	1032	17416	34832	RO	0	Inactive
Hex	0408	4408	8810		1	Active (<i>break detected</i>)
Input 1 Signal Under Range Flag				Value	Process Input Under Range Status	
Dec	1033	17417	34834	RO	0	Inactive
Hex	0409	4409	8812		1	Active (<i>under-range detected</i>)
Input Signal Over Range Flag				Value	Process Input Over Range Status	
Dec	1034	17418	34836	RO	0	Inactive
Hex	040A	440A	8814		1	Active (<i>over-range detected</i>)
Input 1 Cold Junction Compensation				Value	CJC Status	
Dec	1035	17419	34838	RW	0	Disabled
Hex	040B	440B	8816		1	Enabled (<i>default</i>)

Input 1 Multi-point Scaling Enable				Value	Multi-point Scaling Status
Dec	1053	17437	34874	RW	0 Disabled
Hex	041D	441D	883A		1 Enabled (<i>valid only if the input type is linear</i>)
Input 1 Scale Point 1				Multi-Point Scaling Point 1	
Dec	1054	17438	34876	RW	Percentage of the scaled input where multi-point scaling value 1 is applied. 0.1 to 100.0% *set to 100% ends scaling sequence at that point.
Hex	041E	441E	883C		
Input 1 Display Point 1				Multi-Point Scaling Display Value For Point 1	
Dec	1055	17439	34878	RW	Value to display at multi-point scaling point 1 Valid between the scaled input lower & upper limits
Hex	041F	441F	883E		
Input 1 Scale Point 2				Multi-Point Scaling Point 2	
Dec	1056	17440	34880	RW	Percentage of the scaled input where multi-point scaling value 2 is applied. 0.1 to 100.0% *set to 100% ends scaling sequence at that point.
Hex	0420	4420	8840		
Input 1 Display Point 2				Multi-Point Scaling Display Value For Point 2	
Dec	1057	17441	34882	RW	Value to display at multi-point scaling point 2 Valid between the scaled input lower & upper limits
Hex	0421	4421	8842		
Input 1 Scale Point 3				Multi-Point Scaling Point 3	
Dec	1058	17442	34884	RW	Percentage of the scaled input where multi-point scaling value 3 is applied. 0.1 to 100.0% *set to 100% ends scaling sequence at that point.
Hex	0422	4422	8844		
Input 1 Display Point 3				Multi-Point Scaling Display Value For Point 3	
Dec	1059	17443	34886	RW	Value to display at multi-point scaling point 3 Valid between the scaled input lower & upper limits
Hex	0423	4423	8846		
Input 1 Scale Point 4				Multi-Point Scaling Point 4	
Dec	1060	17444	34888	RW	Percentage of the scaled input where multi-point scaling value 4 is applied. 0.1 to 100.0% *set to 100% ends scaling sequence at that point.
Hex	0424	4424	8848		
Input 1 Display Point 4				Multi-Point Scaling Display Value For Point 4	
Dec	1061	17445	34890	RW	Value to display at multi-point scaling point 4 Valid between the scaled input lower & upper limits
Hex	0425	4425	884A		
Input 1 Scale Point 5				Multi-Point Scaling Point 5	
Dec	1062	17446	34892	RW	Percentage of the scaled input where multi-point scaling value 5 is applied. 0.1 to 100.0% *set to 100% ends scaling sequence at that point.
Hex	0426	4426	884C		
Input 1 Display Point 5				Multi-Point Scaling Display Value For Point 5	
Dec	1063	17447	34894	RW	Value to display at multi-point scaling point 5 Valid between the scaled input lower & upper limits
Hex	0427	4427	884E		
Input 1 Scale Point 6				Multi-Point Scaling Point 6	
Dec	1064	17448	34896	RW	Percentage of the scaled input where multi-point scaling value 6 is applied. 0.1 to 100.0% *set to 100% ends scaling sequence at that point.
Hex	0428	4428	8850		
Input 1 Display Point 6				Multi-Point Scaling Display Value For Point 6	
Dec	1065	17449	34898	RW	Value to display at multi-point scaling point 6 Valid between the scaled input lower & upper limits
Hex	0429	4429	8852		
Input 1 Scale Point 7				Multi-Point Scaling Point 7	
Dec	1066	17450	34900	RW	Percentage of the scaled input where multi-point scaling value 7 is applied. 0.1 to 100.0% *set to 100% ends scaling sequence at that point.
Hex	042A	442A	8854		
Input 1 Display Point 7				Multi-Point Scaling Display Value For Point 7	
Dec	1067	17451	34902	RW	Value to display at multi-point scaling point 7 Valid between the scaled input lower & upper limits
Hex	042B	442B	8856		

Input 1 Scale Point 8				RW	Multi-Point Scaling Point 8
Dec	1068	17452	34904		Percentage of the scaled input where multi-point scaling value 8 is applied.
Hex	042C	442C	8858		0.1 to 100.0% *set to 100% ends scaling sequence at that point.
Input 1 Display Point 8				RW	Multi-Point Scaling Display Value For Point 8
Dec	1069	17453	34906		Value to display at multi-point scaling point 8
Hex	042D	442D	885A		Valid between the scaled input lower & upper limits
Input 1 Scale Point 9				RW	Multi-Point Scaling Point 9
Dec	1070	17454	34908		Percentage of the scaled input where multi-point scaling value 9 is applied.
Hex	042E	442E	885C		0.1 to 100.0% *set to 100% ends scaling sequence at that point.
Input 1 Display Point 9				RW	Multi-Point Scaling Display Value For Point 9
Dec	1071	17455	34910		Value to display at multi-point scaling point 9
Hex	042F	442F	885E		Valid between the scaled input lower & upper limits
Input 1 Scale Point 10				RW	Multi-Point Scaling Point 10
Dec	1072	17456	34912		Percentage of the scaled input where multi-point scaling value 10 is applied.
Hex	0430	4430	8860		0.1 to 100.0% *set to 100% ends scaling sequence at that point.
Input 1 Display Point 10				RW	Multi-Point Scaling Display Value For Point 10
Dec	1073	17457	34914		Value to display at multi-point scaling point 10
Hex	0431	4431	8862		Valid between the scaled input lower & upper limits
Input 1 Scale Point 11				RW	Multi-Point Scaling Point 11
Dec	1074	17458	34916		Percentage of the scaled input where multi-point scaling value 11 is applied.
Hex	0432	4432	8864		0.1 to 100.0% *set to 100% ends scaling sequence at that point.
Input 1 Display Point 11				RW	Multi-Point Scaling Display Value For Point 11
Dec	1075	17459	34918		Value to display at multi-point scaling point 11
Hex	0433	4433	8866		Valid between the scaled input lower & upper limits
Input 1 Scale Point 12				RW	Multi-Point Scaling Point 12
Dec	1076	17460	34920		Percentage of the scaled input where multi-point scaling value 12 is applied.
Hex	0434	4434	8868		0.1 to 100.0% *set to 100% ends scaling sequence at that point.
Input 1 Display Point 12				RW	Multi-Point Scaling Display Value For Point 12
Dec	1077	17461	34922		Value to display at multi-point scaling point 12
Hex	0435	4435	886A		Valid between the scaled input lower & upper limits
Input 1 Scale Point 13				RW	Multi-Point Scaling Point 13
Dec	1078	17462	34924		Percentage of the scaled input where multi-point scaling value 13 is applied.
Hex	0436	4436	886C		0.1 to 100.0% *set to 100% ends scaling sequence at that point.
Input 1 Display Point 13				RW	Multi-Point Scaling Display Value For Point 13
Dec	1079	17463	34926		Value to display at multi-point scaling point 13
Hex	0437	4437	886E		Valid between the scaled input lower & upper limits
Input 1 Scale Point 14				RW	Multi-Point Scaling Point 14
Dec	1080	17464	34928		Percentage of the scaled input where multi-point scaling value 14 is applied.
Hex	0438	4438	8870		0.1 to 100.0% *set to 100% ends scaling sequence at that point.
Input 1 Display Point 14				RW	Multi-Point Scaling Display Value For Point 14
Dec	1081	17465	34930		Value to display at multi-point scaling point 14
Hex	0439	4439	8872		Valid between the scaled input lower & upper limits

Input 1 Scale Point 15				Multi-Point Scaling Point 15	
Dec	1082	17466	34932	RW	Percentage of the scaled input where multi-point scaling value 15 is applied. 0.1 to 100.0% *set to 100% ends scaling sequence at that point.
Hex	043A	443A	8874		
Input 1 Display Point 15				Multi-Point Scaling Display Value For Point 15	
Dec	1083	17467	34934	RW	Value to display at multi-point scaling point 15 Valid between the scaled input lower & upper limits
Hex	043B	443B	8876		
User Calibration Type				Value	Calibration Type
Dec	1085	17469	34938	RW	0 None (input 1 base calibration used)
Hex	043D	443D	887A		1 Single Point Calibration
					2 Two Point Calibration
User Calibration Point - Low Value				Two Point Calibration Low Point	
Dec	1086	17470	34940	RW	The input value at which the Low Offset will be applied Valid between input 1 scaled input lower & upper limits
Hex	043E	443E	887C		
User Calibration Low Offset				Two Point Calibration Low Offset Value	
Dec	1087	17471	34942	RW	The Low Offset value applied to the reading at the Low Calibration Point 0.0 to 100.0%
Hex	043F	443F	887E		
User Calibration Point - High Value				Two Point Calibration High Point	
Dec	1088	17472	34944	RW	The input value at which the High Offset will be applied Valid between input 1 scaled input lower & upper limits
Hex	0440	4440	8880		
User Calibration High Offset				Two Point Calibration High Offset Value	
Dec	1089	17473	34946	RW	The High Offset value applied to the reading at the High Calibration Point 0.0 to 100.0%
Hex	0441	4441	8882		

Universal Process Input 2 Parameters

Parameter Name & Register Address							
	Integer	Int +1	Float	Access	Values	& Descriptions	
Universal Input 2 Usage					Value	Process Input Type	
Dec	1166	17550	35100	RW	0	Standard	
Hex	048E	448E	891C		1	Feedback signal for Input 1	
					2	Redundant Sensor (<i>backup for Input 1 Thermocouple or RTD</i>)	
					3	Not Used (<i>or Indication only</i>)	
Universal Process Input 2 Type					Value	Process Input Type	
Dec	1100	17484	34968	RW	0	B Type Thermocouple	
Hex	044C	444C	8898		2	C Type Thermocouple	
					4	D Type Thermocouple	
					6	E Type Thermocouple	
					8	J Type Thermocouple	
					10	K Type Thermocouple	
					12	L Type Thermocouple	
					14	N Type Thermocouple	
					16	R Type Thermocouple	
					18	S Type Thermocouple	
					20	T Type Thermocouple	
					22	PtRh 20%: 40% Thermocouple	
					24	PT100 RTD	

					26	NI120 RTD
					28	0 to 20mA DC
					29	4 to 20mA DC
					30	0 to 50mV DC
					31	10 to 50mV DC
					32	0 to 5V DC
					33	1 to 5V DC
					34	0 to 10V DC
					35	2 to 10V DC
					36	Potentiometer
Input 2 Engineering Units					Value	Engineering Units For Display
Dec	1101	17485	34970	RW	0	= None
Hex	044D	444D	889A		1	= °C (Default for Europe)
					2	= °F (Default for USA)
					3	= °K
					4	= Bar
					5	= pH
					6	= %
					7	= %RH
					8	= PSI
Input 2 Maximum Display Decimal Places					Value	Maximum Number Of Decimal Places In Display
Dec	1102	17486	34972	RW	0	None (e.g. 1234)
Hex	044E	444E	889C		1	One (e.g. 123.4)
					2	Two (e.g. 12.34)
					3	Three (e.g. 1.234)
Input 2 Scaled Input Lower Limit					Scaling Value Low Limit	
Dec	1103	17487	34974	RW	Valid between input 2 range maximum and minimum (see <i>Specifications section for input details</i>)	
Hex	044F	444F	889E			
Input 2 Scaled Input Upper Limit					Scaling Value High Limit	
Dec	1104	17488	34976	RW	Valid between input 2 range maximum and minimum (see <i>Specifications section for input details</i>)	
Hex	0450	4450	88A0			
Input 2 Process Variable Offset					Single Point Calibration PV Offset	
Dec	1105	17489	34978	RW	Used for Single Point Calibration of input 2 Valid between the scaled input lower & upper limits	
Hex	0451	4451	88A2			
Input 2 Filter Time Constant					Input 2 Process Input Filter Time	
Dec	1106	17490	34980	RW	Valid between 0.0 and 512.0	
Hex	0452	4452	88A4			
Input 2 Process Variable					Process Input 2 Value	
Dec	1107	17491	34982	RO	The current input 2 process value	
Hex	0453	4453	88A6			
Input 2 Signal /Sensor Break Flag					Value	Process Input Break Status
Dec	1108	17492	34984	RO	0	Inactive
Hex	0454	4454	88A8		1	Active (<i>break detected</i>)
Input 2 Signal Under Range Flag					Value	Process Input Under Range Status
Dec	1109	17493	34986	RO	0	Inactive
Hex	0455	4455	88AA		1	Active (<i>under-range detected</i>)

Input 2 Signal Over Range Flag				Value	Process Input Over Range Status
Dec	1110	17494	34988	RO	0 Inactive
Hex	0456	4456	88AC		1 Active (<i>over-range detected</i>)
Input 2 Cold Junction Compensation				Value	CJC Status
Dec	1111	17495	34990	RW	0 Disabled
Hex	0457	4457	88AE		1 Enabled (<i>default</i>)
Input 2 Multi-point Scaling Enable				Value	Multi-point Scaling Status
Dec	1129	17513	35026	RW	0 Disabled
Hex	0469	4469	88D2		1 Enabled (<i>only if the input type is linear</i>)
Input 2 Scale Point 1				Multi-Point Scaling Point 1	
Dec	1130	17514	35028	RW	Percentage of the scaled input where multi-point scaling value 1 is applied. 0.1 to 100.0% *set to 100% ends scaling sequence at that point.
Hex	046A	446A	88D4		
Input 2 Display Point 1				Multi-Point Scaling Display Value For Point 1	
Dec	1131	17515	35030	RW	Value to display at multi-point scaling point 1 Valid between the scaled input lower & upper limits
Hex	046B	446B	88D6		
Input 2 Scale Point 2				Multi-Point Scaling Point 2	
Dec	1132	17516	35032	RW	Percentage of the scaled input where multi-point scaling value 2 is applied. 0.1 to 100.0% *set to 100% ends scaling sequence at that point.
Hex	046C	446C	88D8		
Input 2 Display Point 2				Multi-Point Scaling Display Value For Point 2	
Dec	1133	17517	35034	RW	Value to display at multi-point scaling point 2 Valid between the scaled input lower & upper limits
Hex	046D	446D	88DA		
Input 2 Scale Point 3				Multi-Point Scaling Point 3	
Dec	1134	17518	35036	RW	Percentage of the scaled input where multi-point scaling value 3 is applied. 0.1 to 100.0% *set to 100% ends scaling sequence at that point.
Hex	046E	446E	88DC		
Input 2 Display Point 3				Multi-Point Scaling Display Value For Point 3	
Dec	1135	17519	35038	RW	Value to display at multi-point scaling point 3 Valid between the scaled input lower & upper limits
Hex	046F	446F	88DE		
Input 2 Scale Point 4				Multi-Point Scaling Point 4	
Dec	1136	17520	35040	RW	Percentage of the scaled input where multi-point scaling value 4 is applied. 0.1 to 100.0% *set to 100% ends scaling sequence at that point.
Hex	0470	4470	88E0		
Input 2 Display Point 4				Multi-Point Scaling Display Value For Point 4	
Dec	1137	17521	35042	RW	Value to display at multi-point scaling point 4 Valid between the scaled input lower & upper limits
Hex	0471	4471	88E2		
Input 2 Scale Point 5				Multi-Point Scaling Point 5	
Dec	1138	17522	35044	RW	Percentage of the scaled input where multi-point scaling value 5 is applied. 0.1 to 100.0% *set to 100% ends scaling sequence at that point.
Hex	0472	4472	88E4		
Input 2 Display Point 5				Multi-Point Scaling Display Value For Point 5	
Dec	1139	17523	35046	RW	Value to display at multi-point scaling point 5 Valid between the scaled input lower & upper limits
Hex	0473	4473	88E6		
Input 2 Scale Point 6				Multi-Point Scaling Point 6	
Dec	1140	17524	35048	RW	Percentage of the scaled input where multi-point scaling value 6 is applied. 0.1 to 100.0% *set to 100% ends scaling sequence at that point.
Hex	0474	4474	88E8		
Input 2 Display Point 6				Multi-Point Scaling Display Value For Point 6	
Dec	1141	17525	35050	RW	Value to display at multi-point scaling point 6 Valid between the scaled input lower & upper limits
Hex	0475	4475	88EA		

Input 2 Scale Point 7				RW	Multi-Point Scaling Point 7
Dec	1142	17526	35052		Percentage of the scaled input where multi-point scaling value 7 is applied.
Hex	0476	4476	88EC		0.1 to 100.0% *set to 100% ends scaling sequence at that point.
Input 2 Display Point 7				RW	Multi-Point Scaling Display Value For Point 7
Dec	1143	17527	35054		Value to display at multi-point scaling point 7
Hex	0477	4477	88EE		Valid between the scaled input lower & upper limits
Input 2 Scale Point 8				RW	Multi-Point Scaling Point 8
Dec	1144	17528	35056		Percentage of the scaled input where multi-point scaling value 8 is applied.
Hex	0478	4478	88F0		0.1 to 100.0% *set to 100% ends scaling sequence at that point.
Input 2 Display Point 8				RW	Multi-Point Scaling Display Value For Point 8
Dec	1145	17529	35058		Value to display at multi-point scaling point 8
Hex	0479	4479	88F2		Valid between the scaled input lower & upper limits
Input 2 Scale Point 9				RW	Multi-Point Scaling Point 9
Dec	1146	17530	35060		Percentage of the scaled input where multi-point scaling value 9 is applied.
Hex	047A	447A	88F4		0.1 to 100.0% *set to 100% ends scaling sequence at that point.
Input 2 Display Point 9				RW	Multi-Point Scaling Display Value For Point 9
Dec	1147	17531	35062		Value to display at multi-point scaling point 9
Hex	047B	447B	88F6		Valid between the scaled input lower & upper limits
Input 2 Scale Point 10				RW	Multi-Point Scaling Point 10
Dec	1148	17532	35064		Percentage of the scaled input where multi-point scaling value 10 is applied.
Hex	047C	447C	88F8		0.1 to 100.0% *set to 100% ends scaling sequence at that point.
Input 2 Display Point 10				RW	Multi-Point Scaling Display Value For Point 10
Dec	1149	17533	35066		Value to display at multi-point scaling point 10
Hex	047D	447D	88FA		Valid between the scaled input lower & upper limits
Input 2 Scale Point 11				RW	Multi-Point Scaling Point 11
Dec	1150	17534	35068		Percentage of the scaled input where multi-point scaling value 11 is applied.
Hex	047E	447E	88FC		0.1 to 100.0% *set to 100% ends scaling sequence at that point.
Input 2 Display Point 11				RW	Multi-Point Scaling Display Value For Point 11
Dec	1151	17535	35070		Value to display at multi-point scaling point 11
Hex	047F	447F	88FE		Valid between the scaled input lower & upper limits
Input 2 Scale Point 12				RW	Multi-Point Scaling Point 12
Dec	1152	17536	35072		Percentage of the scaled input where multi-point scaling value 12 is applied.
Hex	0480	4480	8900		0.1 to 100.0% *set to 100% ends scaling sequence at that point.
Input 2 Display Point 12				RW	Multi-Point Scaling Display Value For Point 12
Dec	1153	17537	35074		Value to display at multi-point scaling point 12
Hex	0481	4481	8902		Valid between the scaled input lower & upper limits
Input 2 Scale Point 13				RW	Multi-Point Scaling Point 13
Dec	1154	17538	35076		Percentage of the scaled input where multi-point scaling value 13 is applied.
Hex	0482	4482	8904		0.1 to 100.0% *set to 100% ends scaling sequence at that point.
Input 2 Display Point 13				RW	Multi-Point Scaling Display Value For Point 13
Dec	1155	17539	35078		Value to display at multi-point scaling point 13
Hex	0483	4483	8906		Valid between the scaled input lower & upper limits
Input 2 Scale Point 14				RW	Multi-Point Scaling Point 14
Dec	1156	17540	35080		Percentage of the scaled input where multi-point scaling value 14 is applied.
Hex	0484	4484	8908		0.1 to 100.0% *set to 100% ends scaling sequence at that point.

Input 2 Display Point 14				Multi-Point Scaling Display Value For Point 14	
Dec	1157	17541	35082	RW	Value to display at multi-point scaling point 14 Valid between the scaled input lower & upper limits
Hex	0485	4485	890A		
Input 2 Scale Point 15				Multi-Point Scaling Point 15	
Dec	1158	17542	35084	RW	Percentage of the scaled input where multi-point scaling value 15 is applied. 0.1 to 100.0% *set to 100% ends scaling sequence at that point.
Hex	0486	4486	890C		
Input 2 Display Point 15				Multi-Point Scaling Display Value For Point 15	
Dec	1159	17543	35086	RW	Value to display at multi-point scaling point 15 Valid between the scaled input lower & upper limits
Hex	0487	4487	890E		
User Calibration Type				Value	Calibration Type
Dec	1161	17545	35090	RW	0 None (input 2 base calibration used)
Hex	0489	4489	8912		1 Single Point Calibration
					2 Two Point Calibration
User Calibration Point - Low Value				Two Point Calibration Low Point	
Dec	1162	17546	35092	RW	The input value at which the Low Offset will be applied Valid between input 2 scaled input lower & upper limits
Hex	048A	448A	8914		
User Calibration Low Offset				Two Point Calibration Low Offset Value	
Dec	1163	17547	35094	RW	The Low Offset value applied to the reading at the Low Calibration Point 0.0 to 100.0%
Hex	048B	448B	8916		
User Calibration Point - High Value				Two Point Calibration High Point	
Dec	1164	17548	35096	RW	The input value at which the High Offset will be applied Valid between input 2 scaled input lower & upper limits
Hex	048C	448C	8918		
User Calibration High Offset				Two Point Calibration High Offset Value	
Dec	1165	17549	35098	RW	The High Offset value applied to the reading at the High Calibration Point 0.0 to 100.0%
Hex	048D	448D	891A		

Digital Input Setup Parameters

Parameter Name & Register Address						
	Integer	Int +1	Float	Access	Values	& Descriptions
Invert Digital Inputs					Bit	If Bit = 1, Input <i>n</i> is Inverted (ON becomes OFF etc)
Dec	10059	26443	52886	RW	0	Digital Input A
Hex	274B	674B	CE96		1	Digital Input C1
					2	Digital Input C2
					3	Digital Input C3
					4	Digital Input C4
					5	Digital Input C5
					6	Digital Input C6
					7	Digital Input C7
					8	Digital Input C8
Profile Selection Type					Value	Profile Selection & Bit Pattern Format
Dec	10029	26413	52826	RW	0	None
Hex	272D	672D	CE5A		1	Binary
					2	BCD

Digital input Profile Select				Value	Inputs Assigned Exclusively to Profile Selection	
Dec	10030	26414	52828	RW	0	Digital Input C1
Hex	272E	672E	CE5C		1	Digital Input C1 to C2
					2	Digital Input C1 to C3
					3	Digital Input C1 to C4
					4	Digital Input C1 to C5
					5	Digital Input C1 to C6
					6	Digital Input C1 to C7
Digital Input A Usage				Value	Usage for Digital Input A	
Dec	10020	26404	52808	RW	0	Unused
Hex	2724	6724	CE48		1	Control 1 Enable Disable
					2	Control 2 Enable Disable
					3	Control 1 Auto/Manual
					4	Control 2 Auto/Manual
					5	Control 1 Setpoint Selection
					6	Control 2 Setpoint Selection
					7	Control 1 Pretune Enable/Disable
					8	Control 2 Pretune Enable/Disable
					9	Control 1 Selftune Enable/Disable
					10	Control 2 Selftune Enable/Disable
					11	Clear All Latched Outputs
					12	Recorder Digital Start/Stop Trigger
					13	Profile Run/Hold
					14	Profile Abort
					15	Profile Hold Release
					16	Force Output 1 on/off
					17	Force Output 2 on/off
					18	Force Output 2B on/off
					19	Force Output 3 on/off
					20	Force Output 3B on/off
					21	Force Output 4 on/off
					22	Force Output 5 on/off
					23	Output 1 Clear Latch
					24	Output 2 Clear Latch
					25	Output 2B Clear Latch
					26	Output 3 Clear Latch
					27	Output 3B Clear Latch
					28	Output 4 Clear Latch
					29	Output 5 Clear Latch
					30	Up Key Press Mimic
					31	Down Key Press Mimic
					32	Back Key Press Mimic
					33	Right Key Press Mimic
Digital Input C1 Usage				Value	Usage for Digital Input C1	
Dec	10021	26405	52810	RW	0	Unused
Hex	2725	6725	CE4A		1	Control 1 Enable Disable
					2	Control 2 Enable Disable
					3	Control 1 Auto/Manual
					4	Control 2 Auto/Manual

- 5 Control 1 Setpoint Selection
- 6 Control 2 Setpoint Selection
- 7 Control 1 Pretune Enable/Disable
- 8 Control 2 Pretune Enable/Disable
- 9 Control 1 Selftune Enable/Disable
- 10 Control 2 Selftune Enable/Disable
- 11 Clear All Latched Outputs
- 12 Recorder Start/Stop
- 13 Profile Run/Hold
- 14 Profile Abort
- 15 Profile Hold Release
- 16 Force Output 1 on/off
- 17 Force Output 2 on/off
- 18 Force Output 2B on/off
- 19 Force Output 3 on/off
- 20 Force Output 3B on/off
- 21 Force Output 4 on/off
- 22 Force Output 5 on/off
- 23 Output 1 Clear Latch
- 24 Output 2 Clear Latch
- 25 Output 2B Clear Latch
- 26 Output 3 Clear Latch
- 27 Output 3B Clear Latch
- 28 Output 4 Clear Latch
- 29 Output 5 Clear Latch
- 30 Up Key Press Mimic
- 31 Down Key Press Mimic
- 32 Back Key Press Mimic
- 33 Right Key Press Mimic

Digital Input C2 Usage				Value	Usage for Digital Input C2
Dec	10022	26406	52812	RW	0 Unused
Hex	2726	6726	CE4C		1 Control 1 Enable Disable
					2 Control 2 Enable Disable
					3 Control 1 Auto/Manual
					4 Control 2 Auto/Manual
					5 Control 1 Setpoint Selection
					6 Control 2 Setpoint Selection
					7 Control 1 Pretune Enable/Disable
					8 Control 2 Pretune Enable/Disable
					9 Control 1 Selftune Enable/Disable
					10 Control 2 Selftune Enable/Disable
					11 Clear All Latched Outputs
					12 Recorder Digital Start/Stop Trigger
					13 Profile Run/Hold
					14 Profile Abort
					15 Profile Hold Release
					16 Force Output 1 on/off
					17 Force Output 2 on/off
					18 Force Output 2B on/off

19	Force Output 3 on/off					
20	Force Output 3B on/off					
21	Force Output 4 on/off					
22	Force Output 5 on/off					
23	Output 1 Clear Latch					
24	Output 2 Clear Latch					
25	Output 2B Clear Latch					
26	Output 3 Clear Latch					
27	Output 3B Clear Latch					
28	Output 4 Clear Latch					
29	Output 5 Clear Latch					
30	Up Key Press Mimic					
31	Down Key Press Mimic					
32	Back Key Press Mimic					
33	Right Key Press Mimic					
Digital Input C3 Usage				Value	Usage for Digital Input C3	
Dec	10023	26407	52814	RW	0	Unused
Hex	2727	6727	CE4E		1	Control 1 Enable Disable
				2	Control 2 Enable Disable	
				3	Control 1 Auto/Manual	
				4	Control 2 Auto/Manual	
				5	Control 1 Setpoint Selection	
				6	Control 2 Setpoint Selection	
				7	Control 1 Pretune Enable/Disable	
				8	Control 2 Pretune Enable/Disable	
				9	Control 1 Selftune Enable/Disable	
				10	Control 2 Selftune Enable/Disable	
				11	Clear All Latched Outputs	
				12	Recorder Digital Start/Stop Trigger	
				13	Profile Run/Hold	
				14	Profile Abort	
				15	Profile Hold Release	
				16	Force Output 1 on/off	
				17	Force Output 2 on/off	
				18	Force Output 2B on/off	
				19	Force Output 3 on/off	
				20	Force Output 3B on/off	
				21	Force Output 4 on/off	
				22	Force Output 5 on/off	
				23	Output 1 Clear Latch	
				24	Output 2 Clear Latch	
				25	Output 2B Clear Latch	
				26	Output 3 Clear Latch	
				27	Output 3B Clear Latch	
				28	Output 4 Clear Latch	
				29	Output 5 Clear Latch	
				30	Up Key Press Mimic	
				31	Down Key Press Mimic	
				32	Back Key Press Mimic	
				33	Right Key Press Mimic	

Digital Input C4 Usage				Value	Usage for Digital Input C4	
Dec	10024	26408	52816	RW	0	Unused
Hex	2728	6728	CE50		1	Control 1 Enable Disable
					2	Control 2 Enable Disable
					3	Control 1 Auto/Manual
					4	Control 2 Auto/Manual
					5	Control 1 Setpoint Selection
					6	Control 2 Setpoint Selection
					7	Control 1 Pretune Enable/Disable
					8	Control 2 Pretune Enable/Disable
					9	Control 1 Selftune Enable/Disable
					10	Control 2 Selftune Enable/Disable
					11	Clear All Latched Outputs
					12	Recorder Digital Start/Stop Trigger
					13	Profile Run/Hold
					14	Profile Abort
					15	Profile Hold Release
					16	Force Output 1 on/off
					17	Force Output 2 on/off
					18	Force Output 2B on/off
					19	Force Output 3 on/off
					20	Force Output 3B on/off
					21	Force Output 4 on/off
					22	Force Output 5 on/off
					23	Output 1 Clear Latch
					24	Output 2 Clear Latch
					25	Output 2B Clear Latch
					26	Output 3 Clear Latch
					27	Output 3B Clear Latch
					28	Output 4 Clear Latch
					29	Output 5 Clear Latch
					30	Up Key Press Mimic
					31	Down Key Press Mimic
					32	Back Key Press Mimic
					33	Right Key Press Mimic
Digital Input C5 Usage				Value	Usage for Digital Input C5	
Dec	10025	26409	52818	RW	0	Unused
Hex	2729	6729	CE52		1	Control 1 Enable Disable
					2	Control 2 Enable Disable
					3	Control 1 Auto/Manual
					4	Control 2 Auto/Manual
					5	Control 1 Setpoint Selection
					6	Control 2 Setpoint Selection
					7	Control 1 Pretune Enable/Disable
					8	Control 2 Pretune Enable/Disable
					9	Control 1 Selftune Enable/Disable
					10	Control 2 Selftune Enable/Disable
					11	Clear All Latched Outputs
					12	Recorder Digital Start/Stop Trigger

13	Profile Run/Hold					
14	Profile Abort					
15	Profile Hold Release					
16	Force Output 1 on/off					
17	Force Output 2 on/off					
18	Force Output 2B on/off					
19	Force Output 3 on/off					
20	Force Output 3B on/off					
21	Force Output 4 on/off					
22	Force Output 5 on/off					
23	Output 1 Clear Latch					
24	Output 2 Clear Latch					
25	Output 2B Clear Latch					
26	Output 3 Clear Latch					
27	Output 3B Clear Latch					
28	Output 4 Clear Latch					
29	Output 5 Clear Latch					
30	Up Key Press Mimic					
31	Down Key Press Mimic					
32	Back Key Press Mimic					
33	Right Key Press Mimic					
Digital Input C6 Usage				Value	Usage for Digital Input C6	
Dec	10026	26410	52820	RW	0	Unused
Hex	272A	672A	CE54		1	Control 1 Enable Disable
				2	Control 2 Enable Disable	
				3	Control 1 Auto/Manual	
				4	Control 2 Auto/Manual	
				5	Control 1 Setpoint Selection	
				6	Control 2 Setpoint Selection	
				7	Control 1 Pretune Enable/Disable	
				8	Control 2 Pretune Enable/Disable	
				9	Control 1 Selftune Enable/Disable	
				10	Control 2 Selftune Enable/Disable	
				11	Clear All Latched Outputs	
				12	Recorder Digital Start/Stop Trigger	
				13	Profile Run/Hold	
				14	Profile Abort	
				15	Profile Hold Release	
				16	Force Output 1 on/off	
				17	Force Output 2 on/off	
				18	Force Output 2B on/off	
				19	Force Output 3 on/off	
				20	Force Output 3B on/off	
				21	Force Output 4 on/off	
				22	Force Output 5 on/off	
				23	Output 1 Clear Latch	
				24	Output 2 Clear Latch	
				25	Output 2B Clear Latch	
				26	Output 3 Clear Latch	

					27	Output 3B Clear Latch
					28	Output 4 Clear Latch
					29	Output 5 Clear Latch
					30	Up Key Press Mimic
					31	Down Key Press Mimic
					32	Back Key Press Mimic
					33	Right Key Press Mimic
Digital Input C7 Usage					Value	Usage for Digital Input C7
Dec	10027	26411	52822	RW	0	Unused
Hex	272B	672B	CE56		1	Control 1 Enable Disable
					2	Control 2 Enable Disable
					3	Control 1 Auto/Manual
					4	Control 2 Auto/Manual
					5	Control 1 Setpoint Selection
					6	Control 2 Setpoint Selection
					7	Control 1 Pretune Enable/Disable
					8	Control 2 Pretune Enable/Disable
					9	Control 1 Selftune Enable/Disable
					10	Control 2 Selftune Enable/Disable
					11	Clear All Latched Outputs
					12	Recorder Digital Start/Stop Trigger
					13	Profile Run/Hold
					14	Profile Abort
					15	Profile Hold Release
					16	Force Output 1 on/off
					17	Force Output 2 on/off
					18	Force Output 2B on/off
					19	Force Output 3 on/off
					20	Force Output 3B on/off
					21	Force Output 4 on/off
					22	Force Output 5 on/off
					23	Output 1 Clear Latch
					24	Output 2 Clear Latch
					25	Output 2B Clear Latch
					26	Output 3 Clear Latch
					27	Output 3B Clear Latch
					28	Output 4 Clear Latch
					29	Output 5 Clear Latch
					30	Up Key Press Mimic
					31	Down Key Press Mimic
					32	Back Key Press Mimic
					33	Right Key Press Mimic
Digital Input C8 Usage					Value	Usage for Digital Input C8
Dec	10028	26412	52824	RW	0	Unused
Hex	272C	672C	CE58		1	Control 1 Enable Disable
					2	Control 2 Enable Disable
					3	Control 1 Auto/Manual
					4	Control 2 Auto/Manual
					5	Control 1 Setpoint Selection

6	Control 2 Setpoint Selection					
7	Control 1 Pretune Enable/Disable					
8	Control 2 Pretune Enable/Disable					
9	Control 1 Selftune Enable/Disable					
10	Control 2 Selftune Enable/Disable					
11	Clear All Latched Outputs					
12	Recorder Digital Start/Stop Trigger					
13	Profile Run/Hold					
14	Profile Abort					
15	Profile Hold Release					
16	Force Output 1 on/off					
17	Force Output 2 on/off					
18	Force Output 2B on/off					
19	Force Output 3 on/off					
20	Force Output 3B on/off					
21	Force Output 4 on/off					
22	Force Output 5 on/off					
23	Output 1 Clear Latch					
24	Output 2 Clear Latch					
25	Output 2B Clear Latch					
26	Output 3 Clear Latch					
27	Output 3B Clear Latch					
28	Output 4 Clear Latch					
29	Output 5 Clear Latch					
30	Up Key Press Mimic					
31	Down Key Press Mimic					
32	Back Key Press Mimic					
33	Right Key Press Mimic					
Soft Digital 1 Usage				Value	Usage for "Soft" Digital Input S1	
Dec	10036	26420	52840	RW	0	Unused
Hex	2734	6734	CE68		1	Control 1 Enable Disable
				2	Control 2 Enable Disable	
				3	Control 1 Auto/Manual	
				4	Control 2 Auto/Manual	
				5	Control 1 Setpoint Selection	
				6	Control 2 Setpoint Selection	
				7	Control 1 Pretune Enable/Disable	
				8	Control 2 Pretune Enable/Disable	
				9	Control 1 Selftune Enable/Disable	
				10	Control 2 Selftune Enable/Disable	
				11	Clear All Latched Outputs	
				12	Recorder Digital Start/Stop Trigger	
				13	Profile Run/Hold	
				14	Profile Abort	
				15	Profile Hold Release	
				16	Force Output 1 on/off	
				17	Force Output 2 on/off	
				18	Force Output 2B on/off	
				19	Force Output 3 on/off	
				20	Force Output 3B on/off	

21	Force Output 4 on/off					
22	Force Output 5 on/off					
23	Output 1 Clear Latch					
24	Output 2 Clear Latch					
25	Output 2B Clear Latch					
26	Output 3 Clear Latch					
27	Output 3B Clear Latch					
28	Output 4 Clear Latch					
29	Output 5 Clear Latch					
30	Up Key Press Mimic					
31	Down Key Press Mimic					
32	Back Key Press Mimic					
33	Right Key Press Mimic					
Soft Digital 1 OR Digital Inputs				Bit	If Bit value = 1 Input <i>n</i> Is Included in OR Selection	
Dec	10040	26424	52848	RW	0	Digital Input A
Hex	2738	6738	CE70		1	Digital Input C1
					2	Digital Input C2
					3	Digital Input C3
					4	Digital Input C4
					5	Digital Input C5
					6	Digital Input C6
					7	Digital Input C7
					8	Digital Input C8
Soft Digital 1 AND Digital Inputs				Bit	If Bit value = 1 Input <i>n</i> Is Included in AND Selection	
Dec	10041	26425	52850	RW	0	Digital Input A
Hex	2739	6739	CE72		1	Digital Input C1
					2	Digital Input C2
					3	Digital Input C3
					4	Digital Input C4
					5	Digital Input C5
					6	Digital Input C6
					7	Digital Input C7
					8	Digital Input C8
Soft Digital 1 OR Alarms				Bit	If Bit value = 1 Alarm <i>n</i> Is Included in OR Selection	
Dec	10050	26434	52868	RW	0	Alarm 1
Hex	2742	6742	CE84		1	Alarm 2
					2	Alarm 3
					3	Alarm 4
					4	Alarm 5
					5	Alarm 6
					6	Alarm 7
Soft Digital 1 OR Events				Bit	If Bit value = 1 Event <i>n</i> Is Included in OR Selection	
Dec	10051	26435	52870	RW	0	Event 1
Hex	2743	6743	CE86		1	Event 2
					2	Event 3
					3	Event 4
					4	Event 5
					5	Profile Running
					6	Profile End

Soft Digital 2 Usage				Value	Usage for "Soft" Digital Input S2	
Dec	10037	26421	52842	RW	0	Unused
Hex	2735	6735	CE6A		1	Control 1 Enable Disable
				2	Control 2 Enable Disable	
				3	Control 1 Auto/Manual	
				4	Control 2 Auto/Manual	
				5	Control 1 Setpoint Selection	
				6	Control 2 Setpoint Selection	
				7	Control 1 Pretune Enable/Disable	
				8	Control 2 Pretune Enable/Disable	
				9	Control 1 Selftune Enable/Disable	
				10	Control 2 Selftune Enable/Disable	
				11	Clear All Latched Outputs	
				12	Recorder Digital Start/Stop Trigger	
				13	Profile Run/Hold	
				14	Profile Abort	
				15	Profile Hold Release	
				16	Force Output 1 on/off	
				17	Force Output 2 on/off	
				18	Force Output 2B on/off	
				19	Force Output 3 on/off	
				20	Force Output 3B on/off	
				21	Force Output 4 on/off	
				22	Force Output 5 on/off	
				23	Output 1 Clear Latch	
				24	Output 2 Clear Latch	
				25	Output 2B Clear Latch	
				26	Output 3 Clear Latch	
				27	Output 3B Clear Latch	
				28	Output 4 Clear Latch	
				29	Output 5 Clear Latch	
				30	Up Key Press Mimic	
				31	Down Key Press Mimic	
				32	Back Key Press Mimic	
				33	Right Key Press Mimic	
Soft Digital 2 OR Digital Inputs				Bit	If Bit value = 1 Input <i>n</i> Is Included in OR Selection	
Dec	10042	26426	52852	RW	0	Digital Input A
Hex	273A	673A	CE74		1	Digital Input C1
				2	Digital Input C2	
				3	Digital Input C3	
				4	Digital Input C4	
				5	Digital Input C5	
				6	Digital Input C6	
				7	Digital Input C7	
				8	Digital Input C8	

Soft Digital 2 AND Digital Inputs				Bit	If Bit value = 1 Input <i>n</i> Is Included in AND Selection	
Dec	10043	26427	52854	RW	0	Digital Input A
Hex	273B	673B	CE76		1	Digital Input C1
					2	Digital Input C2
					3	Digital Input C3
					4	Digital Input C4
					5	Digital Input C5
					6	Digital Input C6
					7	Digital Input C7
					8	Digital Input C8
Soft Digital 2 OR Alarms				Bit	If Bit value = 1 Alarm <i>n</i> Is Included in OR Selection	
Dec	10052	26436	52872	RW	0	Alarm 1
Hex	2744	6744	CE88		1	Alarm 2
					2	Alarm 3
					3	Alarm 4
					4	Alarm 5
					5	Alarm 6
					6	Alarm 7
Soft Digital 1 OR Events				Bit	If Bit value = 1 Event <i>n</i> Is Included in OR Selection	
Dec	10053	26437	52874	RW	0	Event 1
Hex	2745	6745	CE8A		1	Event 2
					2	Event 3
					3	Event 4
					4	Event 5
					5	Profile Running
					6	Profile End
Soft Digital 3 Usage				Value	Usage for "Soft" Digital Input S3	
Dec	10038	26422	52844	RW	0	Unused
Hex	2736	6736	CE6C		1	Control 1 Enable Disable
					2	Control 2 Enable Disable
					3	Control 1 Auto/Manual
					4	Control 2 Auto/Manual
					5	Control 1 Setpoint Selection
					6	Control 2 Setpoint Selection
					7	Control 1 Pretune Enable/Disable
					8	Control 2 Pretune Enable/Disable
					9	Control 1 Selftune Enable/Disable
					10	Control 2 Selftune Enable/Disable
					11	Clear All Latched Outputs
					12	Recorder Digital Start/Stop Trigger
					13	Profile Run/Hold
					14	Profile Abort
					15	Profile Hold Release
					16	Force Output 1 on/off
					17	Force Output 2 on/off
					18	Force Output 2B on/off
					19	Force Output 3 on/off
					20	Force Output 3B on/off
				21	Force Output 4 on/off	

				22	Force Output 5 on/off	
				23	Output 1 Clear Latch	
				24	Output 2 Clear Latch	
				25	Output 2B Clear Latch	
				26	Output 3 Clear Latch	
				27	Output 3B Clear Latch	
				28	Output 4 Clear Latch	
				29	Output 5 Clear Latch	
				30	Up Key Press Mimic	
				31	Down Key Press Mimic	
				32	Back Key Press Mimic	
				33	Right Key Press Mimic	
Soft Digital 3 OR Digital Inputs				Bit	If Bit value = 1 Input <i>n</i> Is Included in OR Selection	
Dec	10044	26428	52856	RW	0	Digital Input A
Hex	273C	673C	CE78		1	Digital Input C1
					2	Digital Input C2
					3	Digital Input C3
					4	Digital Input C4
					5	Digital Input C5
					6	Digital Input C6
					7	Digital Input C7
					8	Digital Input C8
Soft Digital 3 AND Digital Inputs				Bit	If Bit value = 1 Input <i>n</i> Is Included in AND Selection	
Dec	10045	26429	52858	RW	0	Digital Input A
Hex	273D	673D	CE7A		1	Digital Input C1
					2	Digital Input C2
					3	Digital Input C3
					4	Digital Input C4
					5	Digital Input C5
					6	Digital Input C6
					7	Digital Input C7
					8	Digital Input C8
Soft Digital 3 OR Alarms				Bit	If Bit value = 1 Alarm <i>n</i> Is Included in OR Selection	
Dec	10054	26438	52876	RW	0	Alarm 1
Hex	2746	6746	CE8C		1	Alarm 2
					2	Alarm 3
					3	Alarm 4
					4	Alarm 5
					5	Alarm 6
					6	Alarm 7
Soft Digital 3 OR Events				Bit	If Bit value = 1 Event <i>n</i> Is Included in OR Selection	
Dec	10055	26439	52878	RW	0	Event 1
Hex	2747	6747	CE8E		1	Event 2
					2	Event 3
					3	Event 4
					4	Event 5
					5	Profile Running
					6	Profile End

Soft Digital 4 Usage				Value	Usage for "Soft" Digital Input S4	
Dec	10039	26423	52846	RW	0	Unused
Hex	2737	6737	CE6E		1	Control 1 Enable Disable
					2	Control 2 Enable Disable
					3	Control 1 Auto/Manual
					4	Control 2 Auto/Manual
					5	Control 1 Setpoint Selection
					6	Control 2 Setpoint Selection
					7	Control 1 Pretune Enable/Disable
					8	Control 2 Pretune Enable/Disable
					9	Control 1 Selftune Enable/Disable
					10	Control 2 Selftune Enable/Disable
					11	Clear All Latched Outputs
					12	Recorder Digital Start/Stop Trigger
					13	Profile Run/Hold
					14	Profile Abort
					15	Profile Hold Release
					16	Force Output 1 on/off
					17	Force Output 2 on/off
					18	Force Output 2B on/off
					19	Force Output 3 on/off
					20	Force Output 3B on/off
					21	Force Output 4 on/off
					22	Force Output 5 on/off
					23	Output 1 Clear Latch
					24	Output 2 Clear Latch
					25	Output 2B Clear Latch
					26	Output 3 Clear Latch
					27	Output 3B Clear Latch
					28	Output 4 Clear Latch
					29	Output 5 Clear Latch
					30	Up Key Press Mimic
					31	Down Key Press Mimic
					32	Back Key Press Mimic
					33	Right Key Press Mimic
Soft Digital 4 OR Digital Inputs				Bit	If Bit value = 1 Input <i>n</i> Is Included in OR Selection	
Dec	10046	26430	52860	RW	0	Digital Input A
Hex	273E	673E	CE7C		1	Digital Input C1
					2	Digital Input C2
					3	Digital Input C3
					4	Digital Input C4
					5	Digital Input C5
					6	Digital Input C6
					7	Digital Input C7
					8	Digital Input C8

Soft Digital 4 AND Digital Inputs				Bit	If Bit value = 1 Input <i>n</i> Is Included in AND Selection	
Dec	10047	26431	52862	RW	0	Digital Input A
Hex	273F	673F	CE7E		1	Digital Input C1
					2	Digital Input C2
					3	Digital Input C3
					4	Digital Input C4
					5	Digital Input C5
					6	Digital Input C6
					7	Digital Input C7
					8	Digital Input C8
Soft Digital 4 OR Alarms				Bit	If Bit value = 1 Alarm <i>n</i> Is Included in OR Selection	
Dec	10056	26440	52880	RW	0	Alarm 1
Hex	2748	6748	CE90		1	Alarm 2
					2	Alarm 3
					3	Alarm 4
					4	Alarm 5
					5	Alarm 6
					6	Alarm 7
Soft Digital 4 OR Events				Bit	If Bit value = 1 Event <i>n</i> Is Included in OR Selection	
Dec	10057	26441	52882	RW	0	Event 1
Hex	2749	6749	CE92		1	Event 2
					2	Event 3
					3	Event 4
					4	Event 5
					5	Profile Running
					6	Profile End

Plug-in Module Slot A Parameters

Parameter Name & Register Address						
	Integer	Int +1	Float	Access	Values	& Descriptions
Digital Input A Status					Value	Digital Input A Status
Dec	2115	18499	36998	RO	0	Inactive
Hex	0843	4843	9086		1	Active
Option Slot A Module Type					Value	Module Fitted In Slot A
Dec	2116	18500	37000	RO	0	None Fitted
Hex	0844	4844	9088		1	RS485 Communications
					3	Digital Input A
					4	Auxiliary Input A
					5	Ethernet Communications
					255	Error (<i>unrecognised module</i>)
RS485 Address					Value	RS485 Communications Address
Dec	2117	18501	37002	RW	0	Modbus Master mode
Hex	0845	4845	908A		1 to 255	Modbus Slave Address

RS485 Data Rate				Value	RS485 Communications Baud Rate	
Dec	2118	18502	37004	RW	0	4800
Hex	0846	4846	908C		1	9600
					2	19200 (<i>Default</i>)
					3	38400
					4	57600
					5	115200
RS485 Parity				Value	Parity Used For RS485 Communications	
Dec	2119	18503	37006	RW	0	None
Hex	0847	4847	908E		1	Even
					2	Odd
Auxiliary Input A Type				Value	Auxiliary Analogue A Input Type	
Dec	2120	18504	37008	RW	0	0 to 20mA DC
Hex	0848	4848	9090		1	4 to 20mA DC
					2	0 to 10V DC
					3	2 to 10V DC
					4	0 to 5V DC
					5	1 to 5V DC
Target Setpoint Address				Slave Controller's Setpoint Register Address		
Dec	2121	18505	37010	RW	Target setpoint parameter address for master mode (<i>as required by slave controller</i>)	
Hex	0849	4849	9092			
Master Transmit Format				Value	Data Format For Setpoint Broadcast	
Dec	2123	18507	37014	RW	0	Integer
Hex	084B	484B	9096		1	Integer with 1 decimal place
					2	Floating point number
Master Transmit Setpoint Selection				Value	Source Loop Of Setpoint For Broadcast	
Dec	2110	18494	36988	RW	0	Loop 1 Setpoint
Hex	083E	483E	907C		1	Loop 2 Setpoint
Comms Write Enable/Disable				Value	Communications Status	
Dec	2124	18508	37016	RW	0	Writing via serial communications disabled
Hex	084C	484C	9098		1	Writing via serial communications enabled
Auxiliary Input A Signal Break				Value	Auxiliary Input A Break Status	
Dec	2127	18511	37022	RO	0	Inactive
Hex	084F	484F	909E		1	Active (<i>break detected</i>)
Auxiliary Input A Signal Under Range				Value	Auxiliary Input A Under Range Status	
Dec	2128	18512	37024	RO	0	Inactive
Hex	0850	4850	90A0		1	Active (<i>under-range detected</i>)
Auxiliary Input A Signal Over Range				Value	Auxiliary Input A Over Range Status	
Dec	2129	18513	37026	RO	0	Inactive
Hex	0851	4851	90A2		1	Active (<i>over-range detected</i>)

Plug-in Module Slot 1 Parameters

Parameter Name & Register Address						
	Integer	Int +1	Float	Access	Values	& Descriptions
Plug-in Module 1 Type					Value	Module Fitted In Slot 1
Dec	2130	18514	37028	RO	0	None Fitted
Hex	0852	4852	90A4		1	Single Relay
					2	Single SSR Driver
					3	Linear mA/V DC
					8	Triac
					255	Error (<i>unrecognised module</i>)
Linear mA/V DC Output 1 Type					Value	Linear Output 1 Type
Dec	2131	18515	37030	RW	0	0 to 5V DC
Hex	0853	4853	90A6		1	0 to 10V DC
					2	2 to 10V DC
					3	0 to 20mA DC
					4	4 to 20mA DC
					5	Variable 0 to 10VDC Transmitter PSU
Digital Output 1 Status					Value	Output 1 Status (Relay, SSR Driver or Triac only)
Dec	2132	18516	37032	RO	0	Inactive
Hex	0854	4854	90A8		1	Active
Digital Output 1 Latch Enable					Value	Enable / Disable Latching Of Output
Dec	2135	18519	37038	RW	0	Disable
Hex	0857	4857	90AE		1	Enable
Digital Output 1 Clear Latch					Value	Latch Clear
Dec	2136	18520	37040	RW	0	Do Nothing
Hex	0858	4858	90B0		1	Clear Latch
Digital Output 1 Latch State					Value	Latch State
Dec	2137	18521	37042	RO	0	Unlatched
Hex	0859	4859	90B2		1	Latched
Linear Output 1 Level Status					Linear Output % Value	
Dec	2134	18518	37036	RO		-2.0% to 102.0% of output nominal range (<i>control output will over/under drive by 2%</i>).
Hex	0856	4856	90AC			
Linear Output 1 Function					Value	Linear Output 1 Function
Dec	2144	18528	37056	RW	0	Disabled
Hex	0860	4860	90C0		1	Loop 1 Primary Output Power
					2	Loop 1 Secondary Output Power
					3	Retransmit Loop 1 Actual Setpoint Value
					4	Retransmit Input 1 Process Variable Value
					5	Loop 2 Primary Output Power
					6	Loop 2 Secondary Output Power
					7	Retransmit Loop 2 Actual Setpoint Value
					8	Retransmit Input 2 Process Variable Value
Digital Output 1 Function					Value	Digital Output 1 Function
Dec	10100	26484	52968	RW	0	Disabled
Hex	2774	6774	CEE8		1	Loop 1 Primary Output Power
					2	Loop 1 Secondary Output Power
					3	Loop 1 VMD Open
					4	Loop 1 VMD Close

					5	Loop 2 Primary Output Power
					6	Loop 2 Secondary Output Power
					7	Loop 2 VMD Open
					8	Loop 2 VMD Close
					9	OR Alarm Event Direct
					10	OR Alarm Event Reverse
					11	AND Alarm Event Direct
					12	AND Alarm Event Reverse
Output 1 OR Alarm Selection					Bit	If Bit = 1, Alarm <i>n</i> Is Included in OR Selection
Dec	10107	26491	52982	RW	2	Alarm 1
Hex	277B	677B	CEF6		3	Alarm 2
					4	Alarm 3
					5	Alarm 4
					6	Alarm 5
					7	Alarm 6
					8	Alarm 7
Output 1 OR Event Selection					Bit	If Bit = 1, Event <i>n</i> Is Included in OR Selection
Dec	10108	26492	52984	RW	2	Event 1
Hex	277C	677C	CEF8		3	Event 2
					4	Event 3
					5	Event 4
					6	Event 5
					7	Profile Running
					8	Profile End
Output 1 AND Alarm Selection					Bit	If Bit = 1, Alarm <i>n</i> Is Included in AND Selection
Dec	10109	26493	52986	RW	2	Alarm 1
Hex	277D	677D	CEFA		3	Alarm 2
					4	Alarm 3
					5	Alarm 4
					6	Alarm 5
					7	Alarm 6
					8	Alarm 7
Output 1 AND Event Selection					Bit	If Bit = 1, Event <i>n</i> Is Included in AND Selection
Dec	10110	26494	52988	RW	2	Event 1
Hex	277E	677E	CEFC		3	Event 2
					4	Event 3
					5	Event 4
					6	Event 5
					7	Profile Running
					8	Profile End
Output 1 Retransmit Input 1 Minimum					Value For Loop 1 Retransmit Minimum	
Dec	2152	18536	37072	RW	Displayed value at which the retransmission output reaches its minimum level (e.g. 4mA if type is 4-20mA). Adjustable from -9999 to 9999.9	
Hex	0868	4868	90D0			
Output 1 Retransmit Input 1 Maximum					Value For Loop 1 Retransmit Maximum	
Dec	2153	18537	37074	RW	Displayed value at which the retransmission output reaches its maximum level (e.g. 2mA if type is 4-20mA). Adjustable from -9999 to 9999.9	
Hex	0869	4869	90D2			

Output 1 Retransmit Input 2 Minimum				Value For Loop 2 Retransmit Minimum	
Dec	2400	18784	37568	RW	Displayed value at which the retransmission output reaches its minimum level (e.g. 4mA if type is 4-20mA). Adjustable from -9999 to 9999.9
Hex	0960	4960	92C0		
Output 1 Retransmit Input 2 Maximum				Value For Loop 2 Retransmit Maximum	
Dec	2410	18794	37588	RW	Displayed value at which the retransmission output reaches its maximum level (e.g. 2mA if type is 4-20mA). Adjustable from -9999 to 9999.9
Hex	096A	496A	92D4		

Plug-in Module Slot 2 Parameters

Parameter Name & Register Address						
	Integer	Int +1	Float	Access	Values	& Descriptions
Plug-in Module 2 Type					Value	Module Fitted In Slot 2
Dec	2160	18544	37088	RO	0	None Fitted
Hex	0870	4870	90E0		1	Single Relay
					2	Single SSR Driver
					3	Error (<i>invalid module for this slot</i>)
					8	Triac
					9	Dual Relay
					10	Dual SSR Driver
					11	24VDC Transmitter PSU
					255	Error (<i>unrecognised module</i>)
Output 2 or 2A Status					Value	Output 2 or 2A Status
Dec	2162	18546	37092	RO	0	Inactive
Hex	0872	4872	90E4		1	Active
Output 2B Status					Value	Output 2B Status
Dec	2163	18547	37094	RO	0	Inactive
Hex	0873	4873	90E6		1	Active
Digital Output 2 Latch Enable					Value	Output 2 or 2A Enable / Disable Latching
Dec	2165	18549	37098	RW	0	Disable
Hex	0875	4875	90EA		1	Enable
Digital Output 2 Clear Latch					Value	Output 2 or 2A Latch Clear
Dec	2166	18550	37100	RW	0	Do Nothing
Hex	0876	4876	90EC		1	Clear Latch
Digital Output 2 Latch State					Value	Output 2 or 2A Latch State
Dec	2167	18551	37102	RO	0	Unlatched
Hex	0877	4877	90EE		1	Latched
Digital Output 2B Latch Enable					Value	Output 2B Enable / Disable Latching
Dec	2168	18552	37104	RW	0	Disable
Hex	0878	4878	90F0		1	Enable
Digital Output 2B Clear Latch					Value	Output 2B Latch Clear
Dec	2169	18553	37106	RW	0	Do Nothing
Hex	0879	4879	90F2		1	Clear Latch
Digital Output 2B Latch State					Value	Output 2B Latch State
Dec	2170	18554	37108	RO	0	Unlatched
Hex	087A	487A	90F4		1	Latched

Output 2 or 2A Function				Value	Output 2 or 2A Function	
Dec	10101	26485	52970	RW	0	Disabled
Hex	2775	6775	CEEA		1	Loop 1 Primary Output Power
					2	Loop 1 Secondary Output Power
					3	Loop 1 VMD Open
					4	Loop 1 VMD Close
					5	Loop 2 Primary Output Power
					6	Loop 2 Secondary Output Power
					7	Loop 2 VMD Open
					8	Loop 2 VMD Close
					9	OR Alarm Event Direct
					10	OR Alarm Event Reverse
					11	AND Alarm Event Direct
					12	AND Alarm Event Reverse

Output 2B Function				Value	Output 2B Function	
Dec	10102	26486	52972	RW	0	Disabled
Hex	2776	6776	CEEC		1	Loop 1 Primary Output Power
					2	Loop 1 Secondary Output Power
					3	Loop 1 VMD Open
					4	Loop 1 VMD Close
					5	Loop 2 Primary Output Power
					6	Loop 2 Secondary Output Power
					7	Loop 2 VMD Open
					8	Loop 2 VMD Close
					9	OR Alarm Event Direct
					10	OR Alarm Event Reverse
					11	AND Alarm Event Direct
					12	AND Alarm Event Reverse

Output 2 OR Alarm Selection				Bit	If Bit = 1, Alarm <i>n</i> Is Included in OR Selection	
Dec	10111	26495	52990	RW	2	Alarm 1
Hex	277F	677F	CEFE		3	Alarm 2
					4	Alarm 3
					5	Alarm 4
					6	Alarm 5
					7	Alarm 6
					8	Alarm 7

Output 2 OR Event Selection				Bit	If Bit = 1, Event <i>n</i> Is Included in OR Selection	
Dec	10112	26496	52992	RW	2	Event 1
Hex	2780	6780	CF00		3	Event 2
					4	Event 3
					5	Event 4
					6	Event 5
					7	Profile Running
					8	Profile End

Output 2 AND Alarm Selection				Bit	If Bit = 1, Alarm <i>n</i> Is Included in AND Selection
Dec	10113	26497	52994	RW	2 Alarm 1
Hex	2781	6781	CF02		3 Alarm 2
					4 Alarm 3
					5 Alarm 4
					6 Alarm 5
					7 Alarm 6
					8 Alarm 7
Output 2 AND Event Selection				Bit	If Bit = 1, Event <i>n</i> Is Included in AND Selection
Dec	10114	26498	52996	RW	2 Event 1
Hex	2782	6782	CF04		3 Event 2
					4 Event 3
					5 Event 4
					6 Event 5
					7 Profile Running
					8 Profile End
Output 2B OR Alarm Selection				Bit	If Bit = 1, Alarm <i>n</i> Is Included in OR Selection
Dec	10115	26499	52998	RW	2 Alarm 1
Hex	2783	6783	CF06		3 Alarm 2
					4 Alarm 3
					5 Alarm 4
					6 Alarm 5
					7 Alarm 6
					8 Alarm 7
Output 2B OR Event Selection				Bit	If Bit = 1, Event <i>n</i> Is Included in OR Selection
Dec	10116	26500	53000	RW	2 Event 1
Hex	2784	6784	CF08		3 Event 2
					4 Event 3
					5 Event 4
					6 Event 5
					7 Profile Running
					8 Profile End
Output 2B AND Alarm Selection				Bit	If Bit = 1, Alarm <i>n</i> Is Included in AND Selection
Dec	10117	26501	53002	RW	2 Alarm 1
Hex	2785	6785	CF0A		3 Alarm 2
					4 Alarm 3
					5 Alarm 4
					6 Alarm 5
					7 Alarm 6
					8 Alarm 7
Output 2B AND Event Selection				Bit	If Bit = 1, Event <i>n</i> Is Included in AND Selection
Dec	10118	26502	53004	RW	2 Event 1
Hex	2786	6786	CF0C		3 Event 2
					4 Event 3
					5 Event 4
					6 Event 5
					7 Profile Running
					8 Profile End

Plug-in Module Slot 3 Parameters

Parameter Name & Register Address							
	Integer	Int +1	Float	Access	Values	& Descriptions	
Plug-in Module 3 Type					Value	Module Fitted In Slot 3	
Dec	2192	18576	37152	RO	0	None Fitted	
Hex	0890	4890	9120		1	Single Relay	
					2	Single SSR Driver	
					3	Error (<i>invalid module for this slot</i>)	
					8	Triac	
					9	Dual Relay	
					10	Dual SSR Driver	
					11	24VDC Transmitter PSU	
					255	Error (<i>unrecognised module</i>)	
Output 3 or 3A Status					Value	Output 3 or 3A Status	
Dec	2194	18578	37156		RO	0	Inactive
Hex	0892	4892	9124			1	Active
Output 3B Status					Value	Output 3B Status	
Dec	2195	18579	37158	RO	0	Inactive	
Hex	0893	4893	9126		1	Active	
Digital Output 3 Latch Enable					Value	Output 3 or 3A Enable / Disable Latching	
Dec	2197	18581	37162	RW	0	Disabled	
Hex	0895	4895	912A		1	Enabled	
Digital Output 3 Clear Latch					Value	Output 3 or 3A Latch Clear	
Dec	2198	18582	37164	RW	0	Do Nothing	
Hex	0896	4896	912C		1	Clear Latch	
Digital Output 3 Latch State					Value	Output 3 or 3A Latch State	
Dec	2199	18583	37166	RO	0	Unlatched	
Hex	0897	4897	912E		1	Latched	
Digital Output 3B Latch Enable					Value	Output 3B Enable / Disable Latching	
Dec	2200	18584	37168	RW	0	Disabled	
Hex	0898	4898	9130		1	Enabled	
Digital Output 3B Clear Latch					Value	Output 3B Latch Clear	
Dec	2201	18585	37170	RW	0	Do Nothing	
Hex	0899	4899	9132		1	Clear Latch	
Digital Output 3B Latch State					Value	Output 3B Latch State	
Dec	2202	18586	37172	RO	0	Unlatched	
Hex	089A	489A	9134		1	Latched	
Output 3 Function					Value	Output 3 or 3A Function	
Dec	10103	26487	52974	RW	0	Disabled	
Hex	2777	6777	CEEE		1	Loop 1 Primary Output Power	
					2	Loop 1 Secondary Output Power	
					3	Loop 1 VMD Open	
					4	Loop 1 VMD Close	
					5	Loop 2 Primary Output Power	
					6	Loop 2 Secondary Output Power	
					7	Loop 2 VMD Open	
					8	Loop 2 VMD Close	
					9	OR Alarm Event Direct	

					10	OR Alarm Event Reverse
					11	AND Alarm Event Direct
					12	AND Alarm Event Reverse
Output 3B Function				Value	Output 3B Function	
Dec	10104	26488	52976	RW	0	Disabled
Hex	2778	6778	CEF0		1	Loop 1 Primary Output Power
					2	Loop 1 Secondary Output Power
					3	Loop 1 VMD Open
					4	Loop 1 VMD Close
					5	Loop 2 Primary Output Power
					6	Loop 2 Secondary Output Power
					7	Loop 2 VMD Open
					8	Loop 2 VMD Close
					9	OR Alarm Event Direct
					10	OR Alarm Event Reverse
					11	AND Alarm Event Direct
					12	AND Alarm Event Reverse
Output 3 OR Alarm Selection				Bit	If Bit = 1, Alarm <i>n</i> Is Included in OR Selection	
Dec	10119	26503	53006	RW	2	Alarm 1
Hex	2787	6787	CF0E		3	Alarm 2
					4	Alarm 3
					5	Alarm 4
					6	Alarm 5
					7	Alarm 6
					8	Alarm 7
Output 3 OR Event Selection				Bit	If Bit = 1, Event <i>n</i> Is Included in OR Selection	
Dec	10120	26504	53008	RW	2	Event 1
Hex	2788	6788	CF10		3	Event 2
					4	Event 3
					5	Event 4
					6	Event 5
					7	Profile Running
					8	Profile End
Output 3 AND Alarm Selection				Bit	If Bit = 1, Alarm <i>n</i> Is Included in AND Selection	
Dec	10121	26505	53010	RW	2	Alarm 1
Hex	2789	6789	CF12		3	Alarm 2
					4	Alarm 3
					5	Alarm 4
					6	Alarm 5
					7	Alarm 6
					8	Alarm 7
Output 3 AND Event Selection				Bit	If Bit = 1, Event <i>n</i> Is Included in AND Selection	
Dec	10122	26506	53012	RW	2	Event 1
Hex	278A	678A	CF14		3	Event 2
					4	Event 3
					5	Event 4
					6	Event 5
					7	Profile Running
					8	Profile End

Output 3B OR Alarm Selection				Bit	If Bit = 1, Alarm <i>n</i> Is Included in OR Selection	
Dec	10123	26507	53014	RW	2	Alarm 1
Hex	278B	678B	CF16		3	Alarm 2
					4	Alarm 3
					5	Alarm 4
					6	Alarm 5
					7	Alarm 6
					8	Alarm 7
Output 3B OR Event Selection				Bit	If Bit = 1, Event <i>n</i> Is Included in OR Selection	
Dec	10124	26508	53016	RW	2	Event 1
Hex	278C	678C	CF18		3	Event 2
					4	Event 3
					5	Event 4
					6	Event 5
					7	Profile Running
					8	Profile End
Output 3B AND Alarm Selection				Bit	If Bit = 1, Alarm <i>n</i> Is Included in AND Selection	
Dec	10125	26509	53018	RW	2	Alarm 1
Hex	278D	678D	CF1A		3	Alarm 2
					4	Alarm 3
					5	Alarm 4
					6	Alarm 5
					7	Alarm 6
					8	Alarm 7
Output 3B AND Event Selection				Bit	If Bit = 1, Event <i>n</i> Is Included in AND Selection	
Dec	10126	26510	53020	RW	2	Event 1
Hex	278E	678E	CF1C		3	Event 2
					4	Event 3
					5	Event 4
					6	Event 5
					7	Profile Running
					8	Profile End

Output 4 Parameters

Parameter Name & Register Address						
Integer	Int +1	Float	Access	Values	& Descriptions	
Linear Output 4 Fitted				Value	Linear Output 4 Fitted	
Dec	3000	19384	38768	RO	0	Not fitted
Hex	0BB8	4BB8	9770		1	Fitted
Output 4 Usage				Value	Output 4 Function	
Dec	10105	26489	52978	RW	0	Disabled
Hex	2779	6779	CEF2		1	Loop 1 Primary Output Power
					2	Loop 1 Secondary Output Power
					3	Loop 1 VMD Open
					4	Loop 1 VMD Close
					5	Loop 2 Primary Output Power
					6	Loop 2 Secondary Output Power
					7	Loop 2 VMD Open

				8	Loop 2 VMD Close	
				9	OR Alarm Event Direct	
				10	OR Alarm Event Reverse	
				11	AND Alarm Event Direct	
				12	AND Alarm Event Reverse	
Output 4 Status				Value	Output 4 Status	
Dec	3001	19385	38770	RO	0	Inactive
Hex	0BB9	4BB9	9772		1	Active
Digital Output 4 Latch Enable				Value	Output 4 Latch Enable / Disable	
Dec	3002	19386	38772	RW	0	Disable
Hex	0BBA	4BBA	9774		1	Enable
Digital Output 4 Clear Latch				Value	Output 4 Latch Clear	
Dec	3004	19388	38776	RW	0	Do Nothing
Hex	0BBC	4BBC	9778		1	Clear Latch
Digital Output 4 Latch State				Value	Output 4 Latch State	
Dec	3003	19387	38774	RO	0	Unlatched
Hex	0BBB	4BBB	9776		1	Latched
Output 4 OR Alarm Selection				Bit	If Bit = 1, Alarm <i>n</i> Is Included in OR Selection	
Dec	10127	26511	53022	RW	2	Alarm 1
Hex	278F	678F	CF1E		3	Alarm 2
					4	Alarm 3
					5	Alarm 4
					6	Alarm 5
					7	Alarm 6
					8	Alarm 7
Output 4 OR Event Selection					Bit	If Bit = 1, Event <i>n</i> Is Included in OR Selection
Dec	10128	26512	53024	RW	2	Event 1
Hex	2790	6790	CF20		3	Event 2
					4	Event 3
					5	Event 4
					6	Event 5
					7	Profile Running
					8	Profile End
Output 4 AND Alarm Selection					Bit	If Bit = 1, Alarm <i>n</i> Is Included in AND Selection
Dec	10129	26513	53026	RW	2	Alarm 1
Hex	2791	6791	CF22		3	Alarm 2
					4	Alarm 3
					5	Alarm 4
					6	Alarm 5
					7	Alarm 6
					8	Alarm 7
Output 4 AND Event Selection					Bit	If Bit = 1, Event <i>n</i> Is Included in AND Selection
Dec	10130	26514	53028	RW	2	Event 1
Hex	2792	6792	CF24		3	Event 2
					4	Event 3
					5	Event 4
					6	Event 5
					7	Profile Running
					8	Profile End

Output 5 Parameters

Parameter Name & Register Address							
	Integer	Int +1	Float	Access	Values	& Descriptions	
Linear Output 5 Fitted					Value	Linear Output 5 Fitted	
Dec	3005	19389	38778	RO	0	Not fitted	
Hex	0BBD	4BBD	977A		1	Fitted	
Output 5 Usage					Value	Output 5 Function	
Dec	10106	26490	52980	RW	0	Disabled	
Hex	277A	677A	CEF4		1	Loop 1 Primary Output Power	
					2	Loop 1 Secondary Output Power	
					3	Loop 1 VMD Open	
					4	Loop 1 VMD Close	
					5	Loop 2 Primary Output Power	
					6	Loop 2 Secondary Output Power	
					7	Loop 2 VMD Open	
					8	Loop 2 VMD Close	
					9	OR Alarm Event Direct	
					10	OR Alarm Event Reverse	
					11	AND Alarm Event Direct	
					12	AND Alarm Event Reverse	
Output 5 Status					Value	Output 5 Status	
Dec	3006	19390	38780	RO	0	Inactive	
Hex	0BBE	4BBE	977C		1	Active	
Digital Output 5 Latch Enable					Value	Latch Enable	
Dec	3007	19391	38782	RW	0	Disable	
Hex	0BBF	4BBF	977E		1	Enable	
Digital Output 5 Clear Latch					Value	Latch Clear	
Dec	3009	19393	38786	RW	0	Do Nothing	
Hex	0BC1	4BC1	9782		1	Clear Latch	
Digital Output 5 Latch State					Value	Latch State	
Dec	3008	19392	38784	RO	0	Unlatched	
Hex	0BC0	4BC0	9780		1	Latched	
Output 5 OR Alarm Selection					Bit	If Bit = 1, Alarm <i>n</i> Is Included in OR Selection	
Dec	10131	26515	53030	RW	2	Alarm 1	
Hex	2793	6793	CF26		3	Alarm 2	
					4	Alarm 3	
					5	Alarm 4	
					6	Alarm 5	
					7	Alarm 6	
					8	Alarm 7	
Output 5 OR Event Selection					Bit	If Bit = 1, Event <i>n</i> Is Included in OR Selection	
Dec	10132	26516	53032		RW	2	Event 1
Hex	2794	6794	CF28	3		Event 2	
				4		Event 3	
				5		Event 4	
				6		Event 5	
				7		Profile Running	
				8		Profile End	

Output 5 AND Alarm Selection				Bit	If Bit = 1, Alarm <i>n</i> Is Included in AND Selection	
Dec	10133	26517	53034	RW	2	Alarm 1
Hex	2795	6795	CF2A		3	Alarm 2
					4	Alarm 3
					5	Alarm 4
					6	Alarm 5
					7	Alarm 6
					8	Alarm 7
Output 5 AND Event Selection					Bit	If Bit = 1, Event <i>n</i> Is Included in AND Selection
Dec	10134	26518	53036	RW	2	Event 1
Hex	2796	6796	CF2C		3	Event 2
					4	Event 3
					5	Event 4
					6	Event 5
					7	Profile Running
					8	Profile End

Linear Output 6 Parameters

Parameter Name & Register Address						
	Integer	Int +1	Float	Access	Values	& Descriptions
Linear Output 6 Fitted					Value	Linear Output 6 Fitted
Dec	3016	19400	38800	RO	0	Not fitted
Hex	0BC8	4BC8	9790		1	Fitted
Linear Output 6 Usage					Value	Output 6 Function
Dec	2174	18558	37116	RW	0	Disabled
Hex	087E	487E	90FC		1	Loop 1 Primary Output Power
					2	Loop 1 Secondary Output Power
					3	Retransmit Loop 1 Actual Setpoint Value
					4	Retransmit Input 1 Process Variable Value
					5	Loop 2 Primary Output Power
					6	Loop 2 Secondary Output Power
					7	Retransmit Loop 2 Actual Setpoint Value
				8	Retransmit Input 2 Process Variable Value	
Linear mA/V DC Output 6 Type					Value	Linear Output 6 Type
Dec	3011	19395	38790	RW	0	0 to 5V DC
Hex	0BC3	4BC3	9786		1	0 to 10V DC
					2	2 to 10V DC
					3	0 to 20mA DC
					4	4 to 20mA DC
					5	Variable 0 to 10VDC Transmitter PSU
Linear Output 6 Level Status					Linear Output % Value	
Dec	3014	19398	38796	RO		-2.0% to 102.0% of output nominal range (<i>control output will over/under drive by 2%</i>).
Hex	0BC6	4BC6	978C			
Output 6 Retransmit Input 1 Minimum					Value For Loop 1 Retransmit Minimum	
Dec	2182	18566	37132	RW		Displayed value at which the retransmission output reaches its minimum level (e.g. 4mA if type is 4-20mA).
Hex	0886	4886	910C			Adjustable from -9999 to 9999.9

Output 6 Retransmit Input 1 Maximum				Value For Loop 1 Retransmit Maximum	
Dec	2183	18567	37134	RW	Displayed value at which the retransmission output reaches its maximum level (e.g. 2mA if type is 4-20mA). Adjustable from -9999 to 9999.9
Hex	0887	4887	910E		
Output 6 Retransmit Input 2 Minimum				Value For Loop 2 Retransmit Minimum	
Dec	2430	18814	37628	RW	Displayed value at which the retransmission output reaches its minimum level (e.g. 4mA if type is 4-20mA). Adjustable from -9999 to 9999.9
Hex	097E	497E	92FC		
Output 6 Retransmit Input 2 Maximum				Value For Loop 2 Retransmit Maximum	
Dec	2431	18815	37630	RW	Displayed value at which the retransmission output reaches its maximum level (e.g. 2mA if type is 4-20mA). Adjustable from -9999 to 9999.9
Hex	097F	497F	92FE		

Linear Output 7 Parameters

Parameter Name & Register Address						
	Integer	Int +1	Float	Access	Values	& Descriptions
Linear Output 7 Fitted					Value	Linear Output 7 Fitted
Dec	3026	19410	38820	RO	0	Not fitted
Hex	0BD2	4BD2	97A4		1	Fitted
Linear Output 7 Usage					Value	Output 6 Function
Dec	2203	18587	37174	RW	0	Disabled
Hex	089B	489B	9136		1	Loop 1 Primary Output Power
					2	Loop 1 Secondary Output Power
					3	Retransmit Loop 1 Actual Setpoint Value
					4	Retransmit Input 1 Process Variable Value
					5	Loop 2 Primary Output Power
					6	Loop 2 Secondary Output Power
					7	Retransmit Loop 2 Actual Setpoint Value
					8	Retransmit Input 2 Process Variable Value
Linear mA/V DC Output 7 Type					Value	Linear Output 6 Type
Dec	3021	19405	38810	RW	0	0 to 5V DC
Hex	0BCD	4BCD	979A		1	0 to 10V DC
					2	2 to 10V DC
					3	0 to 20mA DC
					4	4 to 20mA DC
					5	Variable 0 to 10VDC Transmitter PSU
Linear Output 7 Level Status					Linear Output % Value	
Dec	3024	19408	38816	RO	-2.0% to 102.0% of output nominal range (control output will over/under drive by 2%).	
Hex	0BD0	4BD0	97A0			
Output 7 Retransmit Input 1 Minimum					Value For Loop 1 Retransmit Minimum	
Dec	2211	18595	37190	RW	Displayed value at which the retransmission output reaches its minimum level (e.g. 4mA if type is 4-20mA). Adjustable from -9999 to 9999.9	
Hex	08A3	48A3	9146			
Output 7 Retransmit Input 1 Maximum					Value For Loop 1 Retransmit Maximum	
Dec	2212	18596	37192	RW	Displayed value at which the retransmission output reaches its maximum level (e.g. 2mA if type is 4-20mA). Adjustable from -9999 to 9999.9	
Hex	08A4	48A4	9148			
Output 7 Retransmit Input 2 Minimum					Value For Loop 2 Retransmit Minimum	
Dec	2460	18844	37688	RW	Displayed value at which the retransmission output reaches its minimum level (e.g. 4mA if type is 4-20mA). Adjustable from -9999 to 9999.9	
Hex	099C	499C	9338			

Output 7 Retransmit Input 2 Maximum				Value For Loop 2 Retransmit Maximum	
Dec	2461	18845	37690	RW	Displayed value at which the retransmission output reaches its maximum level (e.g. 2mA if type is 4-20mA). Adjustable from -9999 to 9999.9
Hex	099D	499D	933A		

Loop 1 Setpoint Parameters

Parameter Name & Register Address					
	Integer	Int +1	Float	Access	Values & Descriptions
Loop 1 Setpoint Minimum			Minimum Allowed Setpoint For Loop 1		
Dec	3944	20328	40656	RW	Valid between the scaled input lower & upper limits
Hex	0F68	4F68	9ED0		
Loop 1 Setpoint Maximum			Maximum Allowed Setpoint For Loop 1		
Dec	3945	20329	40658	RW	Valid between the scaled input lower & upper limits
Hex	0F69	4F69	9ED2		
Loop 1 Main Local Setpoint Value			Main Setpoint Value For Loop 1		
Dec	3960	20344	40688	RW	Valid between Setpoint Maximum and Minimum
Hex	0F78	4F78	9EF0		
Loop 1 Main Local Setpoint Offset			Offset Of Main Setpoint Of Loop 1		
Dec	3961	20345	40690	RW	Changes effective setpoint (for multi-zone slaves. +ve values added -ve values subtracted. Setpoint always limited by Setpoint Max and Min.
Hex	0F79	4F79	9EF2		
Loop 1 Alternate Local Setpoint Value			Alternate Setpoint Value For Loop 1		
Dec	3962	20346	40692	RW	Valid between Setpoint Maximum and Minimum
Hex	0F7A	4F7A	9EF4		
Loop 1 Alternate Local Setpoint Offset			Offset Of Alternate setpoint Of Loop 1		
Dec	3963	20347	40694	RW	Changes effective setpoint (for multi-zone slaves. +ve values added -ve values subtracted. Setpoint always limited by Setpoint Max and Min.
Hex	0F7B	4F7B	9EF6		
Loop 1 Main Setpoint Source			Value	Main Setpoint Source For Loop 1	
Dec	4050	20434	40868	RW	0 Local Setpoint 1
Hex	0FD2	4FD2	9FA4		1 Not Used
Loop 1 Alternate Setpoint Source			Value	Alternate Setpoint Source For Loop 1	
Dec	4051	20435	40870	RW	0 Not Used
Hex	0FD3	4FD3	9FA6		1 Local Setpoint 2
					2 Input 2 Remote Setpoint
					3 Input A Remote Setpoint
Loop 1 Setpoint Select			Value	Setpoint Select For Loop 1	
Dec	4122	20506	41012	RW	0 Main Setpoint
Hex	101A	501A	A034		1 Alternate setpoint
Loop 1 Setpoint Ramp Rate			Setpoint Ramp Rate For Loop 1		
Dec	4123	20507	41014	RW	0 to 10000 display units per hour (1 to 9999 is ramp rate per hour, either 0 or >10000 = Off)
Hex	101B	501B	A036		
Loop 1 Target Setpoint			Actual Setpoint Value Of Selected Loop 1 Setpoint		
Dec	4125	20509	41018	RO	The Loop 1 target setpoint value when ramping
Hex	101D	501D	A03A		
Operator Access Setpoint Ramp Rate			Value	Operator Access To Loop 1 Setpoint Ramp Rate	
Dec	4126	20510	41020	RW	0 No
Hex	101E	501E	A03C		1 Yes

Operator Access To Setpoint Edit				Value	Operator Access To Edit Loop 1 Setpoint	
Dec	4128	20512	41024	RW	0	No
Hex	1020	5020	A040		1	Yes
Loop 1 Selected Setpoint				Value	Selected Setpoint For Loop 1	
Dec	4127	20511	41022	RO	0	Main Setpoint
Hex	101F	501F	A03E		1	Alternate setpoint
Loop 1 Actual Setpoint				Effective Setpoint Value Of Selected Loop 1 Setpoint		
Dec	8256	24640	49280	RO	The effective setpoint for loop 1 (current instantaneous value of the active setpoint source)	
Hex	2040	6040	C080			

Loop 2 Setpoint Parameters

Parameter Name & Register Address						
	Integer	Int +1	Float	Access	Values	& Descriptions
Loop 2 Setpoint Minimum					Minimum Allowed Setpoint For Loop 2	
Dec	3950	20334	40668	RW	Valid between the scaled input lower & upper limits	
Hex	0F6E	4F6E	9EDC			
Loop 2 Setpoint Maximum					Maximum Allowed Setpoint For Loop 2	
Dec	3951	20335	40670	RW	Valid between the scaled input lower & upper limits	
Hex	0F6F	4F6F	9EDE			
Loop 2 Main Local Setpoint Value					Main Setpoint Value For Loop 2	
Dec	3964	20348	40696	RW	Valid between Setpoint Maximum and Minimum	
Hex	0F7C	4F7C	9EF8			
Loop 2 Main Local Setpoint Offset					Offset Of Main Setpoint Of Loop 2	
Dec	3965	20349	40698	RW	Changes effective setpoint (for multi-zone slaves. +ve values added -ve values subtracted. Setpoint always limited by Setpoint Max and Min.	
Hex	0F7D	4F7D	9EFA			
Loop 2 Alternate Local Setpoint Value					Alternate Setpoint Value For Loop 2	
Dec	3966	20350	40700	RW	Valid between Setpoint Maximum and Minimum	
Hex	0F7E	4F7E	9EFC			
Loop 2 Alternate Local Setpoint Offset					Offset Of Alternate setpoint Of Loop 2	
Dec	3967	20351	40702	RW	Changes effective setpoint (for multi-zone slaves. +ve values added -ve values subtracted. Setpoint always limited by Setpoint Max and Min.	
Hex	0F7F	4F7F	9EFE			
Loop 2 Main Setpoint Source					Value	Main Setpoint Source For Loop 2
Dec	4052	20436	40872	RW	0	Local Setpoint 1
Hex	0FD4	4FD4	9FA8		1	Not Used
Loop 2 Alternate Setpoint Source					Value	Alternate Setpoint Source For Loop 2
Dec	4053	20437	40874	RW	0	Not Used
Hex	0FD5	4FD5	9FAA		1	Local Setpoint 2
					3	Input A Remote Setpoint
Loop 2 Setpoint Select					Value	Setpoint Select For Loop 2
Dec	4200	20584	41168	RW	0	Local Setpoint 1
Hex	1068	5068	A0D0		1	Alternate setpoint
Loop 2 Setpoint Ramp Rate					Setpoint Ramp Rate For Loop 2	
Dec	4201	20585	41170	RW	0 to 10000 display units per hour	
Hex	1069	5069	A0D2		(1 to 9999 is ramp rate per hour, either 0 or >10000 = Off)	

Loop 2 Target Setpoint				Actual Setpoint Value Of Selected Loop 2 Setpoint		
Dec	4203	20587	41174	RO	The Loop 1 target setpoint value when ramping	
Hex	106B	506B	A0D6			
Operator Access To Setpoint Ramp Rate				Value	Operator Access To Loop 2 Setpoint Ramp Rate	
Dec	4204	20588	41176	RW	0	No
Hex	106C	506C	A0D8		1	Yes
Operator Access To Setpoint Edit				Value	Operator Access To Edit Loop 2 Setpoint	
Dec	4206	20590	41180	RW	0	No
Hex	106E	506E	A0DC		1	Yes
Loop 2 Selected Setpoint				Value	Selected Setpoint For Loop 2	
Dec	4205	20589	41178	RO	0	Main Setpoint
Hex	106D	506D	A0DA		1	Alternate setpoint
Loop 2 Actual Setpoint				Effective Setpoint Value Of Selected Loop 2 Setpoint		
Dec	8269	24653	49306	RO	The effective setpoint for loop 1 (current instantaneous value of the active setpoint source)	
Hex	204D	604D	C09A			

Aux A Input Parameters

Parameter Name & Register Address						
	Integer	Int +1	Float	Access	Values & Descriptions	
Auxiliary Input A Scale Minimum				Minimum Input Scaling Value		
Dec	2111	18495	36990	RW	Scale value (between ±0.001 & ±10000) when input A is at minimum value. When used for RSP, setpoint is still constrained by setpoint limits.	
Hex	083F	483F	907E			
Auxiliary Input A Scale Maximum				Maximum Input Scaling Value		
Dec	2112	18496	36992	RW	Scale value (between ±0.001 & ±10000) when input A is at maximum value. When used for RSP, setpoint is still constrained by setpoint limits.	
Hex	0840	4840	9080			
Auxiliary Input A Offset				Offset Applied To Scaled Aux A Value		
Dec	2113	18497	36994	RW	Changes effective setpoint (for multi-zone slaves. +ve values added -ve values subtracted. from +/-0.001 to 20000 units or OFF	
Hex	0841	4841	9082			
Auxiliary Input A Value				Auxiliary Input A Measured Value		
Dec	2114	18498	36996	RO	The current input A value (scaled).	
Hex	0842	4842	9084			

Loop 1 Control Parameters

Parameter Name & Register Address						
	Integer	Int +1	Float	Access	Values & Descriptions	
Loop 1 Manual Control Select				Value Auto/Manual Mode Selection		
Dec	4308	20692	41384	RW	0	Automatic Mode
Hex	10D4	50D4	A1A8		1	Manual Mode
Loop 1 Control Enable Select				Value Loop Control Enable/Disable		
Dec	4309	20693	41386	RW	0	Disable
Hex	10D5	50D5	A1AA		1	Enable
Loop 1 Auto/Manual Operator Access				Value Operator Access To Auto/Manual Control		
Dec	4394	20778	41556	RW	0	Off
Hex	112A	512A	A254		1	On

Loop 1 Control Enable Access				Value	Operator Access To Control Enable/Disable
Dec	4395	20779	41558	RW	0 Off
Hex	112B	512B	A256		1 On
Loop 1 Primary Cycle Time				Cycle Time For Primary Control Outputs	
Dec	4301	20685	41370	RW	0.5 to 512.0 Seconds
Hex	10CD	50CD	A19A		
Loop 1 Secondary Cycle Time				Cycle Time For Secondary Control Outputs	
Dec	4302	20686	41372	RW	0.5 to 512.0 Seconds
Hex	10CE	50CE	A19C		
Loop 1 Control Mode				Value	Control Mode For Loop 1
Dec	4390	20774	41548	RW	0 Standard
Hex	1126	5126	A24C		1 Cascade Mode
					2 Ratio Mode
Loop 1 Control Selection				Value	Control Actuator Type Selection
Dec	4307	20691	41382	RW	0 Standard (<i>Time Proportioned or Continuous Linear PID</i>)
Hex	10D3	50D3	A1A6		1 VMD (<i>3-Point Stepping For Valve Motor Drive</i>)
Loop 1 Control type				Value	Primary Only or Primary & Secondary
Dec	4310	20694	41388	RW	0 Single (<i>Primary Only Control</i>)
Hex	10D6	50D6	A1AC		1 Dual Control (<i>Primary & Secondary Control</i>)
Loop 1 Control Action				Value	Direction Of Control Action
Dec	4311	20695	41390	RW	0 Direct Acting
Hex	10D7	50D7	A1AE		1 Reverse Acting
PID Set 1 - Primary Prop Band				PID Set 1 Primary Proportional Band For Loop 1	
Dec	4312	20696	41392	RW	Primary Proportional Band for Gain Set 1. 1 display unit to 9999 units, but limited to 10 x scaled input span. 0 = On-Off control
Hex	10D8	50D8	A1B0		
PID Set 1 - Secondary Prop Band				PID Set 1 Secondary Proportional Band For Loop 1	
Dec	4313	20697	41394	RW	Secondary Proportional Band for Gain Set 1. 1 display unit to 9999 units, but limited to 10 x scaled input span. 0 = On-Off control
Hex	10D9	50D9	A1B2		
PID Set 1 - Integral Time				PID Set 1 Integral Time For Loop 1	
Dec	4314	20698	41396	RW	Gain Set 1 integral time constant for loop 1 0.1 to 5999 Seconds. 0 or 6000 = OFF
Hex	10DA	50DA	A1B4		
PID Set 1 - Derivative Time				PID Set 1 Derivative Time For Loop 1	
Dec	4315	20699	41398	RW	Gain Set 1 derivative time constant for loop 1 0.1 to 5999 Seconds. 0 or 6000 = OFF
Hex	10DB	50DB	A1B6		
Loop 1 Manual Reset				PID Set 1 Manual Reset (Bias) For Loop 1	
Dec	4316	20700	41400	RW	Working point from 0 to 100 for single control or -100 to 100 for dual control (primary & secondary)
Hex	10DC	50DC	A1B8		
PID Set 1 - Overlap/Deadband				PID Set 1 - Overlap or Deadband For Loop 1	
Dec	4317	20701	41402	RW	PID Set 1 overlap (+ve) or deadband (-ve) between primary & secondary prop bands. In display units - limited to 20% of the combined band width.
Hex	10DD	50DD	A1BA		
PID Set 1 - On/Off Differential				PID Set 1 - On/Off Control Differential For Loop 1	
Dec	4320	20704	41408	RW	The on-off control hysteresis (deadband) for PID Set 1. 1 to 300 display units, centred about the setpoint.
Hex	10E0	50E0	A1C0		

Loop 1 Primary Power Upper limit				Loop 1 Primary Power Upper limit	
Dec	4321	20705	41410	RW	10 to 100%
Hex	10E1	50E1	A1C2		but must be at least 10% above the primary power lower limit.
Loop 1 Primary Power Lower Limit				Loop 1 Primary Power Lower Limit	
Dec	4322	20706	41412	RW	0 to 90%
Hex	10E2	50E2	A1C4		but must be at least 10% below the primary power upper limit.
Loop 1 Secondary Upper Power limit				Loop 1 Secondary Upper Power limit	
Dec	4323	20707	41414	RW	10 to 100%
Hex	10E3	50E3	A1C6		but must be at least 10% above the secondary power lower limit.
Loop 1 Secondary Power Lower limit				Loop 1 Secondary Power Lower limit	
Dec	4324	20708	41416	RW	0 to 90%
Hex	10E4	50E4	A1C8		but must be at least 10% below the primary power upper limit.
Loop 1 Pre-Tune Method				Value	Pre-tune type
Dec	4396	20780	41560	RW	0 Standard
Hex	112C	512C	A258		1 Pretune at Value
Loop 1 Pretune at Value				Value To Pre-tune Loop 1	
Dec	4399	20783	41566	RW	Valid between the scaled input lower & upper limits <i>(applies if Pre-Tune Type = Pre-tune at Value)</i>
Hex	112F	512F	A25E		
Loop 1 Pretune Set				Value	PID Set Pre-tune Will Optimize
Dec	4397	20781	41562	RW	0 PID Set 1
Hex	112D	512D	A25A		1 PID Set 2
					2 PID Set 3
					3 PID Set 4
					4 PID Set 5
Loop 1 Pretune Cascade Loop				Value	Cascade Loop To Be Pre-Tuned
Dec	4398	20782	41564	RW	0 Slave (<i>opens cascade - close when finished</i>)
Hex	112E	512E	A25C		1 Master (<i>tunes master/slave combination</i>)
Loop 1 Pre-Tune Engage/disengage				Value	Pre-Tune Engage/Disengage For Loop 1
Dec	4325	20709	41418	RW	0 Pre-Tune OFF
Hex	10E5	50E5	A1CA		1 Run Pre-Tune
Loop 1 Self-Tune Engage/disengage				Value	Self-Tune Engage/Disengage For Loop 1
Dec	4326	20710	41420	RW	0 Self-Tune OFF
Hex	10E6	50E6	A1CC		1 Self-Tune ON
Loop 1 Loop Alarm Type				Value	Loop Alarm Type For Loop 1
Dec	4327	20711	41422	RW	1 User Defined Time
Hex	10E7	50E7	A1CE		2 Automatic (<i>2x Integral Time</i>)
Loop Alarm Time				Loop Alarm Activation Time	
Dec	4328	20712	41424	RW	1 to 5999 Seconds after output loop 1 power reaches saturation
Hex	10E8	50E8	A1D0		
Loop 1 Primary Power				Loop 1 Primary Power Level	
Dec	4329	20713	41426	RO	The current loop 1 primary power level (0 to 100%)
Hex	10E9	50E9	A1D2		
Loop 1 Secondary Power				Loop 1 Secondary Power Level	
Dec	4330	20714	41428	RO	The current loop 1 secondary power level (0 to 100%)
Hex	10EA	50EA	A1D4		

Loop 1 Combined Power				Loop 1 Combined Primary & Secondary Power Level	
Dec	4331	20715	41430	RO	The current loop 1 combined PID power level (-100 to 100%)
Hex	10EB	50EB	A1D6		
Loop 1 Pre-Tune Status				Value	Pre-Tune Status For Loop 1
Dec	4332	20716	41432	RO	0 Inactive
Hex	10EC	50EC	A1D8		1 Active
Loop 1 Self-Tune Status				Value	Self-Tune Status For Loop 1
Dec	4333	20717	41434	RO	0 Inactive
Hex	10ED	50ED	A1DA		1 Active
Loop 1 Loop Alarm status				Value	Loop Alarm Status For Loop 1
Dec	4334	20718	41436	RO	0 Inactive
Hex	10EE	50EE	A1DC		1 Active
Loop 1 Input Failure Pre-set Power				Loop 1 Input Sensor Break Pre-set Power	
Dec	4335	20719	41438	RW	The pre-defined power output applied if input signal is lost 0 to 100% (-100% to 100% for dual control).
Hex	10EF	50EF	A1DE		
Loop 1 Auto Pre-tune				Value	Auto Pre-Tune At Every Power-up For Loop 1
Dec	4336	20720	41440	RW	0 Disabled
Hex	10F0	50F0	A1E0		1 Enabled
Pre-tune Secondary Status				Value	Pre-tune Secondary Status
Dec	4341	20725	41450	RO	0 No Additional Information
Hex	10F5	50F5	A1EA		1 PV within 5% (<i>Pre-Tune cannot run</i>)
					2 Manual Control Enabled (<i>Pre-Tune cannot run</i>)
					3 Control has On/Off element (<i>Pre-Tune cannot run</i>)
					4 Input not valid (<i>Pre-Tune cannot run</i>)
					5 Control Disabled (<i>Pre-Tune cannot run</i>)
					6 Profile Running (<i>Pre-Tune cannot run</i>)
					7 Setpoint Ramping (<i>Pre-Tune cannot run</i>)
Self-tune Secondary Status				Value	Self-tune Secondary Status
Dec	4342	20726	41452	RO	0 No Additional Information
Hex	10F6	50F6	A1EC		2 Manual Control Enabled (<i>Self-Tune cannot run</i>)
					3 Control has On/Off element (<i>Self-Tune cannot run</i>)
					4 Input not valid (<i>Self-Tune cannot run</i>)
					5 Control Disabled (<i>Self-Tune cannot run</i>)
Loop 1 Anti Wind-up Limit				Loop 1 Anti Wind-up Limit	
Dec	4391	20775	41550	RW	Power level where integral action is suspended. Adjustable from 10.0 to 100.0% of PID power.
Hex	1127	5127	A24E		
Loop 1 Motor Travel Time				Loop 1 Motor Travel Time	
Dec	4343	20727	41454	RW	The motor travel time (from fully open to fully closed) for 3-point stepping VMD control. Adjustable from 5 to 300 seconds.
Hex	10F7	50F7	A1EE		
Loop 1 Minimum Motor On Time				Loop 1 Minimum Motor On Time	
Dec	4344	20728	41456	RW	Minimum drive effort to begin moving valve for 3-point stepping VMD control. In seconds, from 0.02 to 1/10 of Motor Travel Time
Hex	10F8	50F8	A1F0		
Loop 1 VMD Break Action				Value	Loop 1 Sensor Break Action For VMD Control
Dec	4401	20785	41570	RW	0 Close Valve Output On
Hex	1131	5131	A262		1 Open Valve Output On
Loop 1 Valve Close Limit				Loop 1 Minimum Valve Position	
Dec	4376	20760	41520	RW	Minimum position to drive valve in VMD Mode from the valve close limit+1% to 100.0%
Hex	1118	5118	A230		

Loop 1 Valve Open Limit				Loop 1 Maximum Valve Position	
Dec	4377	20761	41522	RW	Maximum position to drive valve in VMD Mode. From 0.0% to the valve open limit-1%
Hex	1119	5119	A232		
Loop 1 PID Set Select				Value	Loop 1 PID Set Selection
Dec	4367	20751	41502	RW	0 PID Set 1
Hex	110F	510F	A21E		1 Gain Schedule Selected by SP
					2 Gain Schedule Selected by PV
					3 PID Set 2
					4 PID Set 3
					5 PID Set 4
					6 PID Set 5
PID Set 2 - Primary Prop Band				PID Set 2 Primary Proportional Band For Loop 1	
Dec	4347	20731	41462	RW	Primary Proportional Band for Gain Set 2. 1 display unit to 9999 units, but limited to 10 x scaled input span. 0 = On-Off control
Hex	10FB	50FB	A1F6		
PID Set 2 - Secondary Prop Band				PID Set 2 Secondary Proportional Band For Loop 1	
Dec	4348	20732	41464	RW	Secondary Proportional Band for Gain Set 2. 1 display unit to 9999 units, but limited to 10 x scaled input span. 0 = On-Off control
Hex	10FC	50FC	A1F8		
PID Set 2 - Integral Time				PID Set 2 - Integral Time For Loop 1	
Dec	4349	20733	41466	RW	Gain Set 2 integral time constant for loop 1 0.1 to 5999 Seconds. 0 or 6000 = OFF
Hex	10FD	50FD	A1FA		
PID Set 2 - Derivative Time				PID Set 2 - Derivative Time For Loop 1	
Dec	4350	20734	41468	RW	Gain Set 2 derivative time constant for loop 1 0.1 to 5999 Seconds. 0 or 6000 = OFF
Hex	10FE	50FE	A1FC		
PID Set 2 - Overlap/Deadband				PID Set 2 - Overlap/Deadband For Loop 1	
Dec	4351	20735	41470	RW	PID Set 2 overlap (+ve) or deadband (-ve) between primary & secondary prop bands. In display units - limited to 20% of the combined band width.
Hex	10FF	50FF	A1FE		
PID Set 2 - On/Off Differential				PID Set 2 - On/Off Differential For Loop 1	
Dec	4378	20762	41524	RW	The on-off control hysteresis (deadband) for PID Set 2. 1 to 300 display units, centred about the setpoint.
Hex	111A	511A	A234		
PID Set 3 - Primary Prop Band				PID Set 3 Primary Proportional Band For Loop 1	
Dec	4352	20736	41472	RW	Primary Proportional Band for Gain Set 3. 1 display unit to 9999 units, but limited to 10 x scaled input span. 0 = On-Off control
Hex	1100	5100	A200		
PID Set 3 - Secondary Prop Band				PID Set 3 Secondary Proportional Band For Loop 1	
Dec	4353	20737	41474	RW	Secondary Proportional Band for Gain Set 3. 1 display unit to 9999 units, but limited to 10 x scaled input span. 0 = On-Off control
Hex	1101	5101	A202		
PID Set 3 - Integral Time				PID Set 3 - Integral Time For Loop 1	
Dec	4354	20738	41476	RW	Gain Set 3 integral time constant for loop 1 0.1 to 5999 Seconds. 0 or 6000 = OFF
Hex	1102	5102	A204		
PID Set 3 - Derivative Time				PID Set 3 - Derivative Time For Loop 1	
Dec	4355	20739	41478	RW	Gain Set 3 derivative time constant for loop 1 0.1 to 5999 Seconds. 0 or 6000 = OFF
Hex	1103	5103	A206		
PID Set 3 - Overlap/Deadband				PID Set 3 - Overlap/Deadband For Loop 1	
Dec	4356	20740	41480	RW	PID Set 3 overlap (+ve) or deadband (-ve) between primary & secondary prop bands. In display units - limited to 20% of the combined band width.
Hex	1104	5104	A208		

PID Set 3 - On/Off Differential				PID Set 3 - On/Off Differential For Loop 1	
Dec	4379	20763	41526	RW	The on-off control hysteresis (deadband) for PID Set 3. 1 to 300 display units, centred about the setpoint.
Hex	111B	511B	A236		
PID Set 4 - Primary Prop Band				PID Set 4 Primary Proportional Band For Loop 1	
Dec	4357	20741	41482	RW	Primary Proportional Band for Gain Set 4. 1 display unit to 9999 units, but limited to 10 x scaled input span. 0 = On-Off control
Hex	1105	5105	A20A		
PID Set 4 - Secondary Prop Band				PID Set 4 Secondary Proportional Band For Loop 1	
Dec	4358	20742	41484	RW	Secondary Proportional Band for Gain Set 4. 1 display unit to 9999 units, but limited to 10 x scaled input span. 0 = On-Off control
Hex	1106	5106	A20C		
PID Set 4 - Integral Time				PID Set 4 - Integral Time For Loop 1	
Dec	4359	20743	41486	RW	Gain Set 4 integral time constant for loop 1 0.1 to 5999 Seconds. 0 or 6000 = OFF
Hex	1107	5107	A20E		
PID Set 4 - Derivative Time				PID Set 4 - Derivative Time For Loop 1	
Dec	4360	20744	41488	RW	Gain Set 4 derivative time constant for loop 1 0.1 to 5999 Seconds. 0 or 6000 = OFF
Hex	1108	5108	A210		
PID Set 4 - Overlap/Deadband				PID Set 4 - Overlap/Deadband For Loop 1	
Dec	4361	20745	41490	RW	PID Set 4 overlap (+ve) or deadband (-ve) between primary & secondary prop bands. In display units - limited to 20% of the combined band width.
Hex	1109	5109	A212		
PID Set 4 - On/Off Differential				PID Set 4 - On/Off Differential For Loop 1	
Dec	4380	20764	41528	RW	The on-off control hysteresis (deadband) for PID Set 4. 1 to 300 display units, centred about the setpoint.
Hex	111C	511C	A238		
PID Set 5 - Primary Prop Band				PID Set 5 Primary Proportional Band For Loop 1	
Dec	4362	20746	41492	RW	Primary Proportional Band for Gain Set 5. 1 display unit to 9999 units, but limited to 10 x scaled input span. 0 = On-Off control
Hex	110A	510A	A214		
PID Set 5 - Secondary Prop Band				PID Set 5 Secondary Proportional Band For Loop 1	
Dec	4363	20747	41494	RW	Secondary Proportional Band for Gain Set 5. 1 display unit to 9999 units, but limited to 10 x scaled input span. 0 = On-Off control
Hex	110B	510B	A216		
PID Set 5 - Integral Time				PID Set 5 - Integral Time For Loop 1	
Dec	4364	20748	41496	RW	Gain Set 5 integral time constant for loop 1 0.1 to 5999 Seconds. 0 or 6000 = OFF
Hex	110C	510C	A218		
PID Set 5 - Derivative Time				PID Set 5 - Derivative Time For Loop 1	
Dec	4365	20749	41498	RW	Gain Set 5 derivative time constant for loop 1 0.1 to 5999 Seconds. 0 or 6000 = OFF
Hex	110D	510D	A21A		
PID Set 5 - Overlap/Deadband				PID Set 5 - Overlap/Deadband For Loop 1	
Dec	4366	20750	41500	RW	PID Set 5 overlap (+ve) or deadband (-ve) between primary & secondary prop bands. In display units - limited to 20% of the combined band width.
Hex	110E	510E	A21C		
PID Set 5 - Overlap/Deadband				PID Set 5 - On/Off Differential For Loop 1	
Dec	4381	20765	41530	RW	The on-off control hysteresis (deadband) for PID Set 5. 1 to 300 display units, centred about the setpoint.
Hex	111D	511D	A23A		
Loop 1 Gain Set 2 Breakpoint				Gain Scheduling PID Set 1 To 2 Switch Point	
Dec	4369	20753	41506	RW	Value (SP or PV) gain scheduling switches from PID Set 1 To 2. Value between Scaled Input 1 Lower & Upper Limits
Hex	1111	5111	A222		
Loop 1 Gain Set 3 Breakpoint				Gain Scheduling PID Set 2 To 3 Switch Point	
Dec	4370	20754	41508	RW	Value (SP or PV) gain scheduling switches from PID Set 2 To 3. Value between Set 2 Breakpoint & Scaled Input 1 Upper Limit.
Hex	1112	5112	A224		

Loop 1 Gain Set 4 Breakpoint				Gain Scheduling PID Set 3 To 4 Switch Point	
Dec	4371	20755	41510	RW	Value (SP or PV) gain scheduling switches from PID Set 3 To 4. Value between Set 3 Breakpoint & Scaled Input 1 Upper Limit.
Hex	1113	5113	A226		
Loop 1 Gain Set 5 Breakpoint				Gain Scheduling PID Set 4 To 5 Switch Point	
Dec	4372	20756	41512	RW	Value (SP or PV) gain scheduling switches from PID Set 4 To 5. Value between Set 4 Breakpoint & Scaled Input 1 Upper Limit.
Hex	1114	5114	A228		
Loop 1 Cascade Mode				Value	Cascade Master/Slave Link Status
Dec	4393	20777	41554	RW	0 Cascade Closed
Hex	1129	5129	A252		1 Cascade Open
Loop 1 Ratio NO Constant				Ratio NO Constant For Atomizing Air	
Dec	4387	20771	41542	RW	0 to 9999 atomizing air value, Added to the x1 value in ratio mode (air flow is x1 + NO).
Hex	1123	5123	A246		
Loop 1 Ratio Sfac Constant				Ratio Sfac Constant	
Dec	4388	20772	41544	RW	Ratio control mode scaling factor. Adjustable from 0.010 to 99.999
Hex	1124	5124	A248		

Loop 2 Control Parameters

Parameter Name & Register Address						
	Integer	Int +1	Float	Access	Values	& Descriptions
Loop 2 Manual Control Select					Value	Selection
Dec	4408	20792	41584	RW	0	Automatic Mode
Hex	1138	5138	A270		1	Manual Mode
Loop 2 Control Enable Select					Value	Control Enable Selection
Dec	4409	20793	41586	RW	0	Disabled
Hex	1139	5139	A272		1	Enabled
Loop 2 Auto/Manual Access					Value	Operator Access To Auto/Manual Control
Dec	4494	20878	41756	RW	0	Off
Hex	118E	518E	A31C		1	On
Loop 2 Control Enable Access					Value	Operator Access To Control Enable/Disable
Dec	4495	20879	41758	RW	0	Off
Hex	118F	518F	A31E		1	On
Loop 2 Primary Cycle Time					Cycle Time For Primary Control Outputs	
Dec	4303	20687	41374	RW	0.5 to 512.0 Seconds	
Hex	10CF	50CF	A19E			
Loop 2 Secondary Cycle Time					Cycle Time For Secondary Control Outputs	
Dec	4304	20688	41376	RW	0.5 to 512.0 Seconds	
Hex	10D0	50D0	A1A0			
Loop 2 Control Selection					Value	Control Actuator Type Selection
Dec	4407	20791	41582	RW	0	Standard (<i>Time Proportioned or Continuous PID</i>)
Hex	1137	5137	A26E		1	VMD (<i>3-Point Stepping for Valve Motor Drive</i>)
Loop 2 Control type					Value	Primary Only or Primary & Secondary
Dec	4410	20794	41588	RW	0	Single (<i>Primary Only Control</i>)
Hex	113A	513A	A274		1	Dual Control (<i>Primary & Secondary Control</i>)

Loop 2 Control Action				Value	Direction Of Control Action	
Dec	4411	20795	41590	RW	0	Direct Acting
Hex	113B	513B	A276		1	Reverse Acting
PID Set 1 - Primary Prop Band				PID Set 1 Primary Proportional Band For Loop 2		
Dec	4412	20796	41592	RW	Primary Proportional Band for Gain Set 1. 1 display unit to 9999 units, but limited to 10 x scaled input span. 0 = On-Off control	
Hex	113C	513C	A278			
PID Set 1 - Secondary Prop Band				PID Set 1 Secondary Proportional Band For Loop 2		
Dec	4413	20797	41594	RW	Secondary Proportional Band for Gain Set 1. 1 display unit to 9999 units, but limited to 10 x scaled input span. 0 = On-Off control	
Hex	113D	513D	A27A			
PID Set 1 - Integral Time				PID Set 1 Integral Time For Loop 2		
Dec	4414	20798	41596	RW	Gain Set 1 integral time constant for loop 2 0.1 to 5999 Seconds. 0 or 6000 = OFF	
Hex	113E	513E	A27C			
PID Set 1 - Derivative Time				PID Set 1 Derivative Time For Loop 2		
Dec	4415	20799	41598	RW	Gain Set 1 derivative time constant for loop 2 0.1 to 5999 Seconds. 0 or 6000 = OFF	
Hex	113F	513F	A27E			
Loop 2 Manual Reset (Bias)				PID Set 1 Manual Reset (Bias) For Loop 2		
Dec	4416	20800	41600	RW	Working point from 0 to 100 for single control or -100 to 100 for dual control (primary & secondary)	
Hex	1140	5140	A280			
PID Set 1 - Overlap/Deadband				PID Set 1 - Overlap or Deadband For Loop 2		
Dec	4417	20801	41602	RW	PID Set 1 overlap (+ve) or deadband (-ve) between primary & secondary prop bands. In display units - limited to 20% of the combined band width.	
Hex	1141	5141	A282			
PID Set 1 - On/Off Differential				PID Set 1 - On/Off Control Differential For Loop 2		
Dec	4420	20804	41608	RW	The on-off control hysteresis (deadband) for PID Set 1. 1 to 300 display units, centred about the setpoint.	
Hex	1144	5144	A288			
Loop 2 Primary Power Upper limit				Loop 2 Primary Power Upper limit		
Dec	4421	20805	41610	RW	10 to 100% but must be at least 10% above the primary power lower limit.	
Hex	1145	5145	A28A			
Loop 2 Primary Power Lower Limit				Loop 2 Primary Power Lower Limit		
Dec	4422	20806	41612	RW	0 to 90% but must be at least 10% below the primary power upper limit.	
Hex	1146	5146	A28C			
Loop 2 Secondary Upper Power limit				Loop 2 Secondary Upper Power limit		
Dec	4423	20807	41614	RW	10 to 100% but must be at least 10% above the secondary power lower limit.	
Hex	1147	5147	A28E			
Loop 2 Secondary Power Lower limit				Loop 2 Secondary Power Lower limit		
Dec	4424	20808	41616	RW	0 to 90% but must be at least 10% below the primary power upper limit.	
Hex	1148	5148	A290			
Loop 2 Pre-Tune Method				Value	Pre-Tune type	
Dec	4496	20880	41760	RW	0	Standard
Hex	1190	5190	A320		1	Pre-tune at Value
Loop 2 Pre-Tune at Value				Value To Pre-Tune Loop 2		
Dec	4499	20883	41766	RW	Valid between the scaled input lower & upper limits (applies if Pre-Tune Type = Pre-Tune at Value)	
Hex	1193	5193	A326			

Loop 2 Pre-Tune Set				Value	PID Set Pre-tune Will Optimize	
Dec	4497	20881	41762	RW	0	PID Set 1
Hex	1191	5191	A322		1	PID Set 2
					2	PID Set 3
					3	PID Set 4
					4	PID Set 5
Loop 2 Pre-Tune Engage/disengage				Value	Pre-Tune Engage/disengage For Loop 2	
Dec	4425	20809	41618	RW	0	Pre-Tune OFF
Hex	1149	5149	A292		1	Run Pre-Tune
Loop 2 Self-Tune Engage/disengage				Value	Self-Tune Engage/disengage For Loop 2	
Dec	4426	20810	41620	RW	0	Self-Tune OFF
Hex	114A	514A	A294		1	Self-Tune ON
Loop 2 Loop Alarm Type				Value	Loop Alarm Type For Loop 2	
Dec	4427	20811	41622	RW	1	User Defined Time
Hex	114B	514B	A296		2	Automatic (2x Integral Time)
Loop Alarm Time				Loop Alarm Activation Time		
Dec	4428	20812	41624	RW	1 to 5999 Seconds after output loop 2 power reaches saturation	
Hex	114C	514C	A298			
Loop 2 Primary Power				Loop 2 Primary Power Level		
Dec	4429	20813	41626	RO	The current loop 2 primary power level (0 to 100%)	
Hex	114D	514D	A29A			
Loop 2 Secondary Power				Loop 2 Secondary Power Level		
Dec	4430	20814	41628	RO	The current loop 2 secondary power level (0 to 100%)	
Hex	114E	514E	A29C			
Loop 2 Combined Power				Loop 2 Combined Primary & Secondary Power Level		
Dec	4431	20815	41630	RO	The current loop 2 combined PID power level (-100 to 100%)	
Hex	114F	514F	A29E			
Loop 2 Pre-Tune Status				Value	Pre-Tune Status For Loop 2	
Dec	4432	20816	41632	RO	0	Inactive
Hex	1150	5150	A2A0		1	Active
Loop 2 Self-Tune Status				Value	Self-Tune Status For Loop 2	
Dec	4433	20817	41634	RO	0	Inactive
Hex	1151	5151	A2A2		1	Active
Loop 2 Loop Alarm status				Value	Loop Alarm Status For Loop 2	
Dec	4434	20818	41636	RO	0	Inactive
Hex	1152	5152	A2A4		1	Active
Loop 2 Input Failure Pre-set Power				Loop 2 Input Sensor Break Pre-set Power		
Dec	4435	20819	41638	RW	The pre-defined power output applied if input signal is lost	
Hex	1153	5153	A2A6		0 to 100% (-100% to 100% for dual control).	
Loop 2 Auto Pre-tune				Value	Auto Pre-Tune At Every Power-up For Loop 2	
Dec	4436	20820	41640	RW	0	Disabled
Hex	1154	5154	A2A8		1	Enabled

Pre-Tune Secondary Status				Value	Loop 2 Pre-Tune Secondary Status	
Dec	4441	20825	41650	RW	0	No Additional Information
Hex	1159	5159	A2B2		1	PV within 5% (<i>Pre-Tune cannot run</i>)
					2	Manual Control Enabled (<i>Pre-Tune cannot run</i>)
					3	Control has On/Off element (<i>Pre-Tune cannot run</i>)
					4	Input not valid (<i>Pre-Tune cannot run</i>)
					5	Control Disabled (<i>Pre-Tune cannot run</i>)
					6	Profile Running (<i>Pre-Tune cannot run</i>)
					7	Setpoint Ramping (<i>Pre-Tune cannot run</i>)
Self-Tune Secondary Status				Value	Loop 2 Self-Tune Secondary Status	
Dec	4442	20826	41652	RW	0	No Additional Information
Hex	115A	515A	A2B4		2	Manual Control Enabled (<i>Self-Tune cannot run</i>)
					3	Control has On/Off element (<i>Self-Tune cannot run</i>)
					4	Input not valid (<i>Self-Tune cannot run</i>)
					5	Control Disabled (<i>Self-Tune cannot run</i>)
Loop 2 Anti Wind-up Limit				Loop 2 Anti Wind-up Limit		
Dec	4491	20875	41750	RW	Power level where integral action is suspended. Adjustable from 10.0 to 100.0% of PID power.	
Hex	118B	518B	A316			
Loop 2 Motor Travel Time				Loop 2 Motor Travel Time		
Dec	4443	20827	41654	RW	The motor travel time (from fully open to fully closed) for 3-point stepping VMD control. Adjustable from 5 to 300 seconds.	
Hex	115B	515B	A2B6			
Loop 2 Minimum Motor On Time				Loop 2 Minimum Motor On Time		
Dec	4444	20828	41656	RW	Minimum drive effort to begin moving valve for 3-point stepping VMD control. In seconds, from 0.02 to 1/10 of Motor Travel Time	
Hex	115C	515C	A2B8			
Loop 2 Valve Break Action				Value	Loop 2 Sensor Break Action For VMD Control	
Dec	4501	20885	41770	RW	0	Close Valve Output On
Hex	1195	5195	A32A		1	Open Valve Output On
Loop 2 Minimum Valve Position				Loop 2 Minimum Valve Position		
Dec	4476	20860	41720	RW	Minimum position to drive valve in VMD Mode from the valve close limit+1% to 100.0%	
Hex	117C	517C	A2F8			
Loop 2 Maximum Valve Position				Loop 2 Maximum Valve Position		
Dec	4477	20861	41722	RW	Maximum position to drive valve in VMD Mode. From 0.0% to the valve open limit-1%	
Hex	117D	517D	A2FA			
Loop 2 PID Set Select				Value	Loop 2 PID Set Selection	
Dec	4467	20851	41702	RW	0	PID Set 1
Hex	1173	5173	A2E6		1	Gain Schedule Selected by SP
					2	Gain Schedule Selected by PV
					3	PID Set 2
					4	PID Set 3
					5	PID Set 4
				6	PID Set 5	
PID Set 2 - Primary Prop Band				PID Set 2 Primary Proportional Band For Loop 2		
Dec	4447	20831	41662	RW	Primary Proportional Band for Gain Set 2. 1 display unit to 9999 units, but limited to 10 x scaled input span. 0 = On-Off control	
Hex	115F	515F	A2BE			
PID Set 2 - Secondary Prop Band				PID Set 2 Secondary Proportional Band For Loop1		
Dec	4448	20832	41664	RW	Secondary Proportional Band for Gain Set 2. 1 display unit to 9999 units, but limited to 10 x scaled input span. 0 = On-Off control	
Hex	1160	5160	A2C0			

PID Set 2 - Integral Time				PID Set 2 - Integral Time For Loop 2	
Dec	4449	20833	41666	RW	Gain Set 2 integral time constant for Loop 2 0.1 to 5999 Seconds. 0 or 6000 = OFF
Hex	1161	5161	A2C2		
PID Set 2 - Derivative Time				PID Set 2 - Derivative Time For Loop 2	
Dec	4450	20834	41668	RW	Gain Set 2 derivative time constant for Loop 2 0.1 to 5999 Seconds. 0 or 6000 = OFF
Hex	1162	5162	A2C4		
PID Set 2 - Overlap/Deadband				PID Set 2 - Overlap/Deadband For Loop 2	
Dec	4451	20835	41670	RW	PID Set 2 overlap (+ve) or deadband (-ve) between primary & secondary prop bands. In display units - limited to 20% of the combined band width.
Hex	1163	5163	A2C6		
PID Set 2 - On/Off Differential				PID Set 2 - On/Off Differential For Loop 2	
Dec	4478	20862	41724	RW	The on-off control hysteresis (deadband) for PID Set 2. 1 to 300 display units, centred about the setpoint.
Hex	117E	517E	A2FC		
PID Set 3 - Primary Prop Band				PID Set 3 Primary Proportional Band For Loop 2	
Dec	4452	20836	41672	RW	Primary Proportional Band for Gain Set 3. 1 display unit to 9999 units, but limited to 10 x scaled input span. 0 = On-Off control
Hex	1164	5164	A2C8		
PID Set 3 - Secondary Prop Band				PID Set 3 Secondary Proportional Band For Loop 2	
Dec	4453	20837	41674	RW	Secondary Proportional Band for Gain Set 3. 1 display unit to 9999 units, but limited to 10 x scaled input span. 0 = On-Off control
Hex	1165	5165	A2CA		
PID Set 3 - Integral Time				PID Set 3 - Integral Time For Loop 2	
Dec	4454	20838	41676	RW	Gain Set 3 integral time constant for Loop 2 0.1 to 5999 Seconds. 0 or 6000 = OFF
Hex	1166	5166	A2CC		
PID Set 3 - Derivative Time				PID Set 3 - Derivative Time For Loop 2	
Dec	4455	20839	41678	RW	Gain Set 3 derivative time constant for Loop 2 0.1 to 5999 Seconds. 0 or 6000 = OFF
Hex	1167	5167	A2CE		
PID Set 3 - Overlap/Deadband				PID Set 3 - Overlap/Deadband For Loop 2	
Dec	4456	20840	41680	RW	PID Set 3 overlap (+ve) or deadband (-ve) between primary & secondary prop bands. In display units - limited to 20% of the combined band width.
Hex	1168	5168	A2D0		
PID Set 3 - On/Off Differential				PID Set 3 - On/Off Differential For Loop 2	
Dec	4479	20863	41726	RW	The on-off control hysteresis (deadband) for PID Set 3. 1 to 300 display units, centred about the setpoint.
Hex	117F	517F	A2FE		
PID Set 4 - Primary Prop Band				PID Set 4 Primary Proportional Band For Loop 2	
Dec	4457	20841	41682	RW	Primary Proportional Band for Gain Set 4. 1 display unit to 9999 units, but limited to 10 x scaled input span. 0 = On-Off control
Hex	1169	5169	A2D2		
PID Set 4 - Secondary Prop Band				PID Set 4 Secondary Proportional Band For Loop 2	
Dec	4458	20842	41684	RW	Secondary Proportional Band for Gain Set 4. 1 display unit to 9999 units, but limited to 10 x scaled input span. 0 = On-Off control
Hex	116A	516A	A2D4		
PID Set 4 - Integral Time				PID Set 4 - Integral Time For Loop 2	
Dec	4459	20843	41686	RW	Gain Set 4 integral time constant for Loop 2 0.1 to 5999 Seconds. 0 or 6000 = OFF
Hex	116B	516B	A2D6		
PID Set 4 - Derivative Time				PID Set 4 - Derivative Time For Loop 2	
Dec	4460	20844	41688	RW	Gain Set 4 derivative time constant for Loop 2 0.1 to 5999 Seconds. 0 or 6000 = OFF
Hex	116C	516C	A2D8		

PID Set 4 - Overlap/Deadband				PID Set 4 - Overlap/Deadband For Loop 2	
Dec	4461	20845	41690	RW	PID Set 4 overlap (+ve) or deadband (-ve) between primary & secondary prop bands. In display units - limited to 20% of the combined band width.
Hex	116D	516D	A2DA		
PID Set 4 - On/Off Differential				PID Set 4 - On/Off Differential For Loop 2	
Dec	4480	20864	41728	RW	The on-off control hysteresis (deadband) for PID Set 4. 1 to 300 display units, centred about the setpoint.
Hex	1180	5180	A300		
PID Set 5 - Primary Prop Band				PID Set 5 Primary Proportional Band For Loop 2	
Dec	4462	20846	41692	RW	Primary Proportional Band for Gain Set 5. 1 display unit to 9999 units, but limited to 10 x scaled input span. 0 = On-Off control
Hex	116E	516E	A2DC		
PID Set 5 - Secondary Prop Band				PID Set 5 Secondary Proportional Band For Loop 2	
Dec	4463	20847	41694	RW	Secondary Proportional Band for Gain Set 5. 1 display unit to 9999 units, but limited to 10 x scaled input span. 0 = On-Off control
Hex	116F	516F	A2DE		
PID Set 5 - Integral Time				PID Set 5 - Integral Time For Loop 2	
Dec	4464	20848	41696	RW	Gain Set 5 integral time constant for Loop 2 0.1 to 5999 Seconds. 0 or 6000 = OFF
Hex	1170	5170	A2E0		
PID Set 5 - Derivative Time				PID Set 5 - Derivative Time For Loop 2	
Dec	4465	20849	41698	RW	Gain Set 5 derivative time constant for Loop 2 0.1 to 5999 Seconds. 0 or 6000 = OFF
Hex	1171	5171	A2E2		
PID Set 5 - Overlap/Deadband				PID Set 5 - Overlap/Deadband For Loop 2	
Dec	4466	20850	41700	RW	PID Set 5 overlap (+ve) or deadband (-ve) between primary & secondary prop bands. In display units - limited to 20% of the combined band width.
Hex	1172	5172	A2E4		
PID Set 5 - On/Off Differential				PID Set 5 - On/Off Differential For Loop 2	
Dec	4481	20865	41730	RW	The on-off control hysteresis (deadband) for PID Set 5. 1 to 300 display units, centred about the setpoint.
Hex	1181	5181	A302		
Loop 2 Gain Set 2 Breakpoint				Gain Scheduling PID Set 1 To 2 Switch Point	
Dec	4469	20853	41706	RW	Value (SP or PV) gain scheduling switches from PID Set 1 to 2. Value between Scaled Input 2 Lower & Upper Limits
Hex	1175	5175	A2EA		
Loop 2 Gain Set 3 Breakpoint				Gain Scheduling PID Set 2 To 3 Switch Point	
Dec	4470	20854	41708	RW	Value (SP or PV) gain scheduling switches from PID Set 2 to 3. Value between Set 2 Breakpoint & Scaled Input 2 Upper Limit.
Hex	1176	5176	A2EC		
Loop 2 Gain Set 4 Breakpoint				Gain Scheduling PID Set 3 To 4 Switch Point	
Dec	4471	20855	41710	RW	Value (SP or PV) gain scheduling switches from PID Set 3 to 4. Value between Set 3 Breakpoint & Scaled Input 2 Upper Limit.
Hex	1177	5177	A2EE		
Loop 2 Gain Set 5 Breakpoint				Gain Scheduling PID Set 4 To 5 Switch Point	
Dec	4472	20856	41712	RW	Value (SP or PV) gain scheduling switches from PID Set 4 to 5. Value between Set 4 Breakpoint & Scaled Input 2 Upper Limit.
Hex	1178	5178	A2F0		
Slave Setpoint Scale Minimum				0% Master Power Demand to Slave Setpoint Scaling	
Dec	4485	20869	41738	RW	The effective cascade slave setpoint value equating to 0% power demand from the master loop.
Hex	1185	5185	A30A		
Slave Setpoint Scale Maximum				100% Master Power Demand to Slave Setpoint Scaling	
Dec	4486	20870	41740	RW	The effective cascade slave setpoint value equating to 100% power demand from the master loop.
Hex	1186	5186	A30C		
Slave Setpoint				Slave Setpoint Value for Cascade Control	
Dec	4492	20876	41752	RW	The slave setpoint valve when in Cascade Control Mode. Only write to this parameter if the unit is cascade status is OPEN (e.g. when tuning slave).
Hex	118C	518C	A318		

Alarm Parameters

Parameter Name & Register Address							
	Integer	Int +1	Float	Access	Values	& Descriptions	
Alarm 1 Input Source					Value	Alarm 1 Source	
Dec	6143	22527	45054	RW	0	Input 1	
Hex	17FF	57FF	AFFE		1	Input 2	
					2	Aux A Input	
					3	Control Loop 1 Primary Power	
					4	Control Loop 1 Secondary Power	
					5	Control Loop 2 Primary Power	
					6	Control Loop 2 Secondary Power	
					7	Loop 1	
					8	Loop 2	
Alarm 1 Type					Value	Alarm 1 Type	
Dec	6144	22528	45056	RW	0	Unused	
Hex	1800	5800	B000		1	Process High Alarm	
					2	Process Low Alarm	
					3	Deviation Alarm (SP-PV)	
					4	Band Alarm	
					5	Input Rate of Change	
					6	Input/Sensor Break Alarm	
					7	Loop Alarm	
					10	% memory used	
					11	High Power Alarm	
					12	Low Power Alarm	
Alarm 1 Value					Value At Which Alarm 1 Activates		
Dec	6145	22529	45058		RW	Limited by input scaling for alarm types 1 to 4. Not used for alarms 5, 6 or 7. 0 to 100% for alarms 10 to 12.	
Hex	1801	5801	B002				
Alarm 1 Rate of Change Value					Process Variable Rate of Change Alarm Threshold		
Dec	6150	22534	45068	RW	Value for Rate of Change Alarm. Alarm 1 activates when PV change exceeds this level. From 0.0 to 99999		
Hex	1806	5806	B00C				
Alarm 1 Hysteresis					Alarm 1 Hysteresis Value		
Dec	6146	22530	45060	RW	Deadband value (<i>on "safe" side of alarm</i>), through which signal must pass before alarm 1 deactivates. Limited by the input scaling span		
Hex	1802	5802	B004				
Alarm 1 Inhibit Enable					Value	Alarm 1 Power-up/Setpoint Change Inhibit	
Dec	6147	22531	45062	RW	0	Disabled	
Hex	1803	5803	B006		1	Enabled	
Alarm 1 Status					Value	Alarm 1 Status	
Dec	6148	22532	45064	RO	0	Inactive	
Hex	1804	5804	B008		1	Active	
Alarm 1 Inhibit Status					Value	Alarm 1 Inhibit Status	
Dec	6149	22533	45066	RO	0	Not Inhibited	
Hex	1805	5805	B00A		1	Inhibited	

Alarm 1 Main Label				Main Language Name For Alarm 1 In Status Screen		
Dec	6151	22535	45070	RW	8 ASCII characters replacing the title "Alarm 1" in alarm status screens when main display language is used, read/written with Modbus functions 16 or 23. Valid characters are 0 to 9, a to z, A to Z, plus ß ö () - and _ .	
Hex	1807	5807	B00E			
Alarm 1 Alternate Label				Alternate Language Name For Alarm 1 In Status Screen		
Dec	6152	22536	45072	RW	8 ASCII characters replacing the title "Alarm 1" in alarm status screens when the alternate language is used, read/written with Modbus functions 16 or 23. Valid characters are 0 to 9, a to z, A to Z, plus ß ö () - and _ .	
Hex	1808	5808	B010			
Alarm 1 Minimum Duration				Alarm 1 Minimum Duration		
Dec	6153	22537	45074	RW	Minimum time alarm 1 must be passed its threshold before activating (deactivation is not affected by this parameter). From 0 to 9999 secs	
Hex	1809	5809	B012			
Alarm 2 Input Source				Value	Source	
Dec	6159	22543	45086	RW	0	Input 1
Hex	180F	580F	B01E		1	Input 2
					2	Aux A Input
					3	Control Loop 1 Primary Power
					4	Control Loop 1 Secondary Power
					5	Control Loop 2 Primary Power
					6	Control Loop 2 Secondary Power
					7	Loop 1
					8	Loop 2
Alarm 2 Type				Value	Alarm 2 Type	
Dec	6160	22544	45088	RW	0	Unused
Hex	1810	5810	B020		1	Process High Alarm
					2	Process Low Alarm
					3	Deviation Alarm (SP-PV)
					4	Band Alarm
					5	Input Rate of Change
					6	Input/Sensor Break Alarm
					7	Loop Alarm
					10	% memory used
					11	High Power Alarm
					12	Low Power Alarm
Alarm 2 Value					Value At Which Alarm 2 Activates	
Dec	6161	22545	45090		RW	Limited by input scaling for alarm types 1 to 4. Not used for alarms 5, 6 or 7. 0 to 100% for alarms 10 to 12.
Hex	1811	5811	B022			
Alarm 2 Rate of Change Value				Process Variable Rate of Change Alarm Threshold		
Dec	6166	22550	45100	RW	Value for Rate of Change Alarm. Alarm 2 activates when PV change exceeds this level. From 0.0 to 99999	
Hex	1816	5816	B02C			
Alarm 2 Hysteresis				Alarm 2 Hysteresis Value		
Dec	6162	22546	45092	RW	Deadband value (on "safe" side of alarm), through which signal must pass before Alarm 2 deactivates. Limited by the input scaling span	
Hex	1812	5812	B024			
Alarm 2 Inhibit Enable/disable				Value	Alarm 2 Power-up/Setpoint Change Inhibit	
Dec	6163	22547	45094	RW	0	Disabled
Hex	1813	5813	B026		1	Enabled

Alarm 2 Status				Value	Alarm 2 Status
Dec	6164	22548	45096	RO	0 Inactive
Hex	1814	5814	B028		1 Active
Alarm 2 Inhibit Status				Value	Alarm 2 Inhibit Status
Dec	6165	22549	45098	RO	0 Not Inhibited
Hex	1815	5815	B02A		1 Inhibited
Alarm 2 Label				Main Language Name for Alarm 2 In Status Screen	
Dec	6167	22551	45102	RW	8 ASCII characters replacing the title "Alarm 2" in alarm status screens when main display language is used, read/written with Modbus functions 16 or 23. Valid characters are 0 to 9, a to z, A to Z, plus ß ö () - and _ .
Hex	1817	5817	B02E		
Alarm 2 Alternate Label				Alternate Language Name for Alarm 2 In Status Screen	
Dec	6168	22552	45104	RW	8 ASCII characters replacing the title "Alarm 2" in alarm status screens when the alternate language is used, read/written with Modbus functions 16 or 23. Valid characters are 0 to 9, a to z, A to Z, plus ß ö () - and _ .
Hex	1818	5818	B030		
Alarm 2 Minimum Duration				Alarm 2 Minimum Duration	
Dec	6169	22553	45106	RW	Minimum time alarm 2 must be passed its threshold before activating (deactivation is not affected by this parameter). From 0 to 9999 secs
Hex	1819	5819	B032		
Alarm 3 Input Source				Value	Source
Dec	6175	22559	45118	RW	0 Input 1
Hex	181F	581F	B03E		1 Input 2
					2 Aux A Input
					3 Control Loop 1 Primary Power
					4 Control Loop 1 Secondary Power
					5 Control Loop 2 Primary Power
					6 Control Loop 2 Secondary Power
					7 Loop 1
					8 Loop 2
Alarm 3 Type				Value	Alarm 3 Type
Dec	6176	22560	45120	RW	0 Unused
Hex	1820	5820	B040		1 Process High Alarm
					2 Process Low Alarm
					3 Deviation Alarm (SP-PV)
					4 Band Alarm
					5 Input Rate of Change
					6 Input/Sensor Break Alarm
					7 Loop Alarm
					10 % memory used
					11 High Power Alarm
					12 Low Power Alarm

Alarm 3 Value				Value At Which Alarm 3 Activates	
Dec	6177	22561	45122	RW	Limited by input scaling for alarm types 1 to 4. Not used for alarms 5, 6 or 7. 0 to 100% for alarms 10 to 12.
Hex	1821	5821	B042		
Alarm 3 Rate of Change Value				Process Variable Rate of Change Alarm Threshold	
Dec	6182	22566	45132	RW	Value for Rate of Change Alarm. Alarm 3 activates when PV change exceeds this level. From 0.0 to 99999
Hex	1826	5826	B04C		
Alarm 3 Hysteresis				Alarm 3 Hysteresis Value	
Dec	6178	22562	45124	RW	Deadband value (on "safe" side of alarm), through which signal must pass before Alarm 3 deactivates. Limited by the input scaling span
Hex	1822	5822	B044		
Alarm 3 Inhibit Enable/disable				Value	Alarm 3 Power-up/Setpoint Change Inhibit
Dec	6179	22563	45126	RW	0 Disabled
Hex	1823	5823	B046		1 Enabled
Alarm 3 Status				Value	Alarm 3 Status
Dec	6180	22564	45128	RO	0 Inactive
Hex	1824	5824	B048		1 Active
Alarm 3 Inhibit Status				Value	Alarm 3 Inhibit Status
Dec	6181	22565	45130	RO	0 Not Inhibited
Hex	1825	5825	B04A		1 Inhibited
Alarm 3 Label				Main Language Name For Alarm 3 In Status Screen	
Dec	6183	22567	45134	RW	8 ASCII characters replacing the title "Alarm 3" in alarm status screens when main display language is used, read/written with Modbus functions 16 or 23. Valid characters are 0 to 9, a to z, A to Z, plus ß ö () - and _ .
Hex	1827	5827	B04E		
Alarm 3 Alternate Label				Alternate Language Name For Alarm 3 In Status Screen	
Dec	6184	22568	45136	RW	8 ASCII characters replacing the title "Alarm 3" in alarm status screens when the alternate language is used, read/written with Modbus functions 16 or 23. Valid characters are 0 to 9, a to z, A to Z, plus ß ö () - and _ .
Hex	1828	5828	B050		
Alarm 3 Minimum Duration				Alarm 3 Minimum Duration	
Dec	6185	22569	45138	RW	Minimum time alarm 3 must be passed its threshold before activating (deactivation is not affected by this parameter). From 0 to 9999 secs
Hex	1829	5829	B052		
Alarm 4 Input Source				Value	Source
Dec	6191	22575	45150	RW	0 Input 1
Hex	182F	582F	B05E		1 Input 2
					2 Aux A Input
					3 Control Loop 1 Primary Power
					4 Control Loop 1 Secondary Power
					5 Control Loop 2 Primary Power
					6 Control Loop 2 Secondary Power
					7 Loop 1
				8 Loop 2	

Alarm 4 Type				Value	Alarm 4 Type	
Dec	6192	22576	45152	RW	0	Unused
Hex	1830	5830	B060		1	Process High Alarm
					2	Process Low Alarm
					3	Deviation Alarm (SP-PV)
					4	Band Alarm
					5	Input Rate of Change
					6	Input/Sensor Break Alarm
					7	Loop Alarm
					10	% memory used
					11	High Power Alarm
					12	Low Power Alarm
Alarm 4 Value				Value At Which Alarm 4 Activates		
Dec	6193	22577	45154	RW	Limited by input scaling for alarm types 1 to 4. Not used for alarms 5, 6 or 7. 0 to 100% for alarms 10 to 12.	
Hex	1831	5831	B062			
Alarm 4 Rate of Change Value				Process Variable Rate of Change Alarm Threshold		
Dec	6198	22582	45164	RW	Value for Rate of Change Alarm. Alarm 4 activates when PV change exceeds this level. From 0.0 to 99999	
Hex	1836	5836	B06C			
Alarm 4 Hysteresis				Alarm 4 Hysteresis Value		
Dec	6194	22578	45156	RW	Deadband value (on "safe" side of alarm), through which signal must pass before Alarm 4 deactivates. Limited by the input scaling span	
Hex	1832	5832	B064			
Alarm 4 Inhibit Enable/disable				Value	Alarm 4 Power-up/Setpoint Change Inhibit	
Dec	6195	22579	45158	RW	0	Disabled
Hex	1833	5833	B066		1	Enabled
Alarm 4 Status				Value	Alarm 4 Status	
Dec	6196	22580	45160	RO	0	Inactive
Hex	1834	5834	B068		1	Active
Alarm 4 Inhibit Status				Value	Alarm 4 Inhibit Status	
Dec	6197	22581	45162	RO	0	Not Inhibited
Hex	1835	5835	B06A		1	Inhibited
Alarm 4 Label				Main Language Name For Alarm 4 In Status Screen		
Dec	6199	22583	45166	RW	8 ASCII characters replacing the title "Alarm 4" in alarm status screens when main display language is used, read/written with Modbus functions 16 or 23. Valid characters are 0 to 9, a to z, A to Z, plus ß ö () - and _ .	
Hex	1837	5837	B06E			
Alarm 4 Alternate Label				Alternate Language Name For Alarm 4 In Status Screen		
Dec	6200	22584	45168	RW	8 ASCII characters replacing the title "Alarm 4" in alarm status screens when the alternate language is used, read/written with Modbus functions 16 or 23. Valid characters are 0 to 9, a to z, A to Z, plus ß ö () - and _ .	
Hex	1838	5838	B070			
Alarm 4 Minimum Duration				Alarm 4 Minimum Duration		
Dec	6201	22585	45170	RW	Minimum time alarm 4 must be passed its threshold before activating (deactivation is not affected by this parameter). From 0 to 9999 secs	
Hex	1839	5839	B072			

Alarm 5 Input Source				Value	Source	
Dec	6207	22591	45182	RW	0	Input 1
Hex	183F	583F	B07E		1	Input 2
					2	Aux A Input
					3	Control Loop 1 Primary Power
					4	Control Loop 1 Secondary Power
					5	Control Loop 2 Primary Power
					6	Control Loop 2 Secondary Power
					7	Loop 1
					8	Loop 2
Alarm 5 Type				Value	Alarm 5 Type	
Dec	6208	22592	45184	RW	0	Unused
Hex	1840	5840	B080		1	Process High Alarm
					2	Process Low Alarm
					3	Deviation Alarm (SP-PV)
					4	Band Alarm
					5	Input Rate of Change
					6	Input/Sensor Break Alarm
					7	Loop Alarm
					10	% memory used
					11	High Power Alarm
					12	Low Power Alarm
Alarm 5 Value					Value At Which Alarm 5 Activates	
Dec	6209	22593	45186		RW	Limited by input scaling for alarm types 1 to 4. Not used for alarms 5, 6 or 7. 0 to 100% for alarms 10 to 12.
Hex	1841	5841	B082			
Alarm 5 Rate of Change Value				Process Variable Rate of Change Alarm Threshold		
Dec	6214	22598	45196	RW	Value for Rate of Change Alarm. Alarm 5 activates when PV change exceeds this level. From 0.0 to 99999	
Hex	1846	5846	B08C			
Alarm 5 Hysteresis				Alarm 5 Hysteresis Value		
Dec	6210	22594	45188	RW	Deadband value (on "safe" side of alarm), through which signal must pass before Alarm 5 deactivates. Limited by the input scaling span	
Hex	1842	5842	B084			
Alarm 5 Inhibit Enable/disable				Value	Alarm 5 Power-up/Setpoint Change Inhibit	
Dec	6211	22595	45190	RW	0	Disabled
Hex	1843	5843	B086		1	Enabled
Alarm 5 Status				Value	Alarm 5 Status	
Dec	6212	22596	45192	RO	0	Inactive
Hex	1844	5844	B088		1	Active
Alarm 5 Inhibit Status				Value	Alarm 5 Inhibit Status	
Dec	6213	22597	45194	RO	0	Not Inhibited
Hex	1845	5845	B08A		1	Inhibited
Alarm 5 Label				Main Language Name For Alarm 5 In Status Screen		
Dec	6215	22599	45198	RW	8 ASCII characters replacing the title "Alarm 5" in alarm status screens when main display language is used, read/written with Modbus functions 16 or 23. Valid characters are 0 to 9, a to z, A to Z, plus ß ö () - and _.	
Hex	1847	5847	B08E			

Alarm 5 Alternate Label				Alternate Language Name For Alarm 5 In Status Screen		
Dec	6216	22600	45200	RW	8 ASCII characters replacing the title "Alarm 5" in alarm status screens when the alternate language is used, read/written with Modbus functions 16 or 23. Valid characters are 0 to 9, a to z, A to Z, plus ß ö () - and _ .	
Hex	1848	5848	B090			
Alarm 5 Minimum Duration				Alarm 5 Minimum Duration		
Dec	6217	22601	45202	RW	Minimum time alarm 5 must be passed its threshold before activating (deactivation is not affected by this parameter). From 0 to 9999 secs	
Hex	1849	5849	B092			
Alarm 6 Input Source				Value	Source	
Dec	6223	22607	45214	RW	0	Input 1
Hex	184F	584F	B09E		1	Input 2
					2	Aux A Input
					3	Control Loop 1 Primary Power
					4	Control Loop 1 Secondary Power
					5	Control Loop 2 Primary Power
					6	Control Loop 2 Secondary Power
					7	Loop 1
				8	Loop 2	
Alarm 5 Type				Value	Alarm 5 Type	
Dec	6224	22608	45216	RW	0	Unused
Hex	1850	5850	B0A0		1	Process High Alarm
					2	Process Low Alarm
					3	Deviation Alarm (SP-PV)
					4	Band Alarm
					5	Input Rate of Change
					6	Input/Sensor Break Alarm
					7	Loop Alarm
					10	% memory used
					11	High Power Alarm
					12	Low Power Alarm
Alarm 6 Value					Value At Which Alarm 6 Activates	
Dec	6225	22609	45218	RW	Limited by input scaling for alarm types 1 to 4. Not used for alarms 5, 6 or 7. 0 to 100% for alarms 10 to 12.	
Hex	1851	5851	B0A2			
Alarm 6 Rate of Change Value				Process Variable Rate of Change Alarm Threshold		
Dec	6230	22614	45228	RW	Value for Rate of Change Alarm. Alarm 6 activates when PV change exceeds this level. From 0.0 to 99999	
Hex	1856	5856	B0AC			
Alarm 6 Hysteresis				Alarm 6 Hysteresis Value		
Dec	6226	22610	45220	RW	Deadband value (on "safe" side of alarm), through which signal must pass before Alarm 6 deactivates. Limited by the input scaling span	
Hex	1852	5852	B0A4			
Alarm 6 Inhibit Enable/disable				Value	Alarm 6 Power-up/Setpoint Change Inhibit	
Dec	6227	22611	45222	RW	0	Disabled
Hex	1853	5853	B0A6		1	Enabled
Alarm 6 Status				Value	Alarm 6 Status	
Dec	6228	22612	45224	RO	0	Inactive
Hex	1854	5854	B0A8		1	Active

Alarm 6 Inhibit Status				Value	Alarm 6 Inhibit Status	
Dec	6229	22613	45226	RO	0	Not Inhibited
Hex	1855	5855	B0AA		1	Inhibited
Alarm 6 Label				Main Language Name For Alarm 6 In Status Screen		
Dec	6231	22615	45230	RW	8 ASCII characters replacing the title "Alarm 6" in alarm status screens when main display language is used, read/written with Modbus functions 16 or 23. Valid characters are 0 to 9, a to z, A to Z, plus ß ö () - and _ .	
Hex	1857	5857	B0AE			
Alarm 6 Alternate Label				Alternate Language Name For Alarm 6 In Status Screen		
Dec	6232	22616	45232	RW	8 ASCII characters replacing the title "Alarm 6" in alarm status screens when the alternate language is used, read/written with Modbus functions 16 or 23. Valid characters are 0 to 9, a to z, A to Z, plus ß ö () - and _ .	
Hex	1858	5858	B0B0			
Alarm 6 Minimum Duration				Alarm 6 Minimum Duration		
Dec	6233	22617	45234	RW	Minimum time alarm 6 must be passed its threshold before activating (deactivation is not affected by this parameter). From 0 to 9999 secs	
Hex	1859	5859	B0B2			
Alarm 7 Input Source				Value	Source	
Dec	6239	22623	45246	RW	0	Input 1
Hex	185F	585F	B0BE		1	Input 2
					2	Aux A Input
					3	Control Loop 1 Primary Power
					4	Control Loop 1 Secondary Power
					5	Control Loop 2 Primary Power
					6	Control Loop 2 Secondary Power
					7	Loop 1
					8	Loop 2
Alarm 7 Type				Value	Alarm 7 Type	
Dec	6240	22624	45248	RW	0	Unused
Hex	1860	5860	B0C0		1	Process High Alarm
					2	Process Low Alarm
					3	Deviation Alarm (SP-PV)
					4	Band Alarm
					5	Input Rate of Change
					6	Input/Sensor Break Alarm
					7	Loop Alarm
					10	% memory used
					11	High Power Alarm
					12	Low Power Alarm
Alarm 7 Value					Value At Which Alarm 7 Activates	
Dec	6241	22625	45250		RW	Limited by input scaling for alarm types 1 to 4. Not used for alarms 5, 6 or 7. 0 to 100% for alarms 10 to 12.
Hex	1861	5861	B0C2			
Alarm 7 Rate of Change Value				Process Variable Rate of Change Alarm Threshold		
Dec	6246	22630	45260	RW	Value for Rate of Change Alarm. Alarm 7 activates when PV change exceeds this level. From 0.0 to 99999	
Hex	1866	5866	B0CC			
Alarm 7 Hysteresis				Alarm 7 Hysteresis Value		
Dec	6242	22626	45252	RW	Deadband value (on "safe" side of alarm), through which signal must pass before Alarm 7 deactivates. Limited by the input scaling span	
Hex	1862	5862	B0C4			

Alarm 7 Inhibit Enable/disable				Value	Alarm 7 Power-up/Setpoint Change Inhibit
Dec	6243	22627	45254	RW	0 Disabled
Hex	1863	5863	B0C6		1 Enabled
Alarm 7 Status				Value	Alarm 7 Status
Dec	6244	22628	45256	RO	0 Inactive
Hex	1864	5864	B0C8		1 Active
Alarm 7 Inhibit Status				Value	Alarm 7 Inhibit Status
Dec	6245	22629	45258	RO	0 Not Inhibited
Hex	1865	5865	B0CA		1 Inhibited
Alarm 7 Label				Main Language Name For Alarm 7 In Status Screen	
Dec	6247	22631	45262	RW	8 ASCII characters replacing the title "Alarm 7" in alarm status screens when main display language is used, read/written with Modbus functions 16 or 23. Valid characters are 0 to 9, a to z, A to Z, plus ß ö () - and _ .
Hex	1867	5867	B0CE		
Alarm 7 Alternate Label				Alternate Language Name For Alarm 7 In Status Screen	
Dec	6248	22632	45264	RW	8 ASCII characters replacing the title "Alarm 7" in alarm status screens when the alternate language is used, read/written with Modbus functions 16 or 23. Valid characters are 0 to 9, a to z, A to Z, plus ß ö () - and _ .
Hex	1868	5868	B0D0		
Alarm 7 Minimum Duration				Alarm 7 Minimum Duration	
Dec	6249	22633	45266	RW	Minimum time alarm 7 must be passed its threshold before activating (deactivation is not affected by this parameter). From 0 to 9999 secs
Hex	1869	5869	B0D2		

Recorder & Clock Parameters

Parameter Name & Register Address						
	Integer	Int +1	Float	Access	Values	& Descriptions
Recording Sample Interval					Value	Recording Sample Interval
Dec	7550	23934	47868	RW	0	Every Second
Hex	1D7E	5D7E	BAFC		1	Every 2 Seconds
					2	Every 5 Seconds
					3	Every 10 Seconds
					4	Every 15 Seconds
					5	Every 30 Seconds
					6	Every Minute
					7	Every 2 Minutes
					8	Every 5 Minutes
					9	Every 10 Minutes
					10	Every 15 Minutes
					11	Every 30 Minutes
Recording Mode					Value	Recording Mode
Dec	7551	23935	47870	RW	0	Record until memory used
Hex	1D7F	5D7F	BAFE		1	Continuous FIFO buffer
Manual Recording Trigger					Value	Manual Recording Trigger
Dec	7552	23936	47872	RW	0	Manual Recording Trigger Off
Hex	1D80	5D80	BB00		1	Manual Recording Trigger On
Data Recorder Fitted					Value	Data Recorder Fitted
Dec	7553	23937	47874	RO	0	Not Fitted
Hex	1D81	5D81	BB02		1	Recorder Fitted

Memory Remaining				Remaining Data Recorder Capacity		
Dec	7554	23938	47876	RO	The unused memory remaining, in bytes.	
Hex	1D82	5D82	BB04			
Time Remaining				Remaining Data Recorder Time		
Dec	7555	23939	47878	RO	Approximate recording time remaining until memory filled, in seconds. Based on the current recorder settings & sample rate.	
Hex	1D83	5D83	BB06			
Recorder Auto-Alarm Trigger				Value	Automatic Data Recorder Trigger	
Dec	7563	23947	47894	RW	0	None
Hex	1D8B	5D8B	BB16		1	On Alarm
					2	On Profile Run
					3	On Alarm or Profile Running
Operator Access To Record Trigger				Value	Operator Access To Manual Record Trigger	
Dec	7559	23943	47886	RW	0	No
Hex	1D87	5D87	BB0E		1	Yes
Recorder Status In Operator Mode				Value	Recorder Status Visible In Operator Mode	
Dec	7560	23944	47888	RW	0	No
Hex	1D88	5D88	BB10		1	Yes
Record Input 1 Process Variable				Value	Record Process Variable Of Input 1	
Dec	7572	23956	47912	RW	0	Do Not Record PV
Hex	1D94	5D94	BB28		1	Record PV Value
Record Input 1 Max Between Samples				Value	Record Max PV For Input 1 Since Last Sample	
Dec	7573	23957	47914	RW	0	Do Not Record Maximum PV
Hex	1D95	5D95	BB2A		1	Record Maximum PV Between Samples
Record Input 1 Min Between Samples				Value	Record Min PV For Input 1 Since Last Sample	
Dec	7574	23958	47916	RW	0	Do Not Record Minimum PV
Hex	1D96	5D96	BB2C		1	Record Minimum PV Between Samples
Record Input 2 Process Variable				Value	Record Process Variable Of Input 2	
Dec	7607	23991	47982	RW	0	Do Not Record PV
Hex	1DB7	5DB7	BB6E		1	Record PV Value
Record Input 2 Max Between Samples				Value	Record Max PV For Input 2 Since Last Sample	
Dec	7608	23992	47984	RW	0	Do Not Record Maximum PV
Hex	1DB8	5DB8	BB70		1	Record Maximum PV Between Samples
Record Input 2 Min Between Samples				Value	Record Min PV For Input 2 Since Last Sample	
Dec	7609	23993	47986	RW	0	Do Not Record Minimum PV
Hex	1DB9	5DB9	BB72		1	Record Minimum PV Between Samples
Record Aux A Input				Value	Record Auxiliary A Input Value	
Dec	7606	23990	47980	RW	0	Do Not Record Aux A
Hex	1DB6	5DB6	BB6C		1	Record Aux A Value
Record Loop 1 Actual Setpoint				Value	Record Effective Value of Loop 1 Setpoint	
Dec	7575	23959	47918	RW	0	Do Not Record Setpoint
Hex	1D97	5D97	BB2E		1	Record Actual Setpoint
Record Loop 2 Actual Setpoint				Value	Record Effective Value of Loop 2 Setpoint	
Dec	7610	23994	47988	RW	0	Do Not Record Setpoint
Hex	1DBA	5DBA	BB74		1	Record Actual Setpoint

Record Loop 1 Primary Power				Value	Record Primary Power Value For Loop 1	
Dec	7576	23960	47920	RW	0	Do Not Record Primary Power
Hex	1D98	5D98	BB30		1	Record Primary Power
Record Loop 1 Secondary Power				Value	Record Secondary Power Value For Loop 1	
Dec	7577	23961	47922	RW	0	Do Not Record Secondary Power
Hex	1D99	5D99	BB32		1	Record Secondary Power
Record Loop 2 Primary Power				Value	Record Primary Power Value For Loop 2	
Dec	7611	23995	47990	RW	0	Do Not Record Primary Power
Hex	1DBB	5DBB	BB76		1	Record Primary Power
Record Loop 2 Secondary Power				Value	Record Secondary Power Value For Loop 2	
Dec	7612	23996	47992	RW	0	Do Not Record Secondary Power
Hex	1DBC	5DBC	BB78		1	Record Secondary Power
Record Alarm 1 Status				Value	Record Change Of State For Alarm 1	
Dec	7578	23962	47924	RW	0	Do Not Record Alarm 1
Hex	1D9A	5D9A	BB34		1	Record Alarm 1
Record Alarm 2 Status				Value	Record Change Of State For Alarm 2	
Dec	7579	23963	47926	RW	0	Do Not Record Alarm 2
Hex	1D9B	5D9B	BB36		1	Record Alarm 2
Record Alarm 3 Status				Value	Record Change Of State For Alarm 3	
Dec	7580	23964	47928	RW	0	Do Not Record Alarm 3
Hex	1D9C	5D9C	BB38		1	Record Alarm 3
Record Alarm 4 Status				Value	Record Change Of State For Alarm 4	
Dec	7581	23965	47930	RW	0	Do Not Record Alarm 4
Hex	1D9D	5D9D	BB3A		1	Record Alarm 4
Record Alarm 5 Status				Value	Record Change Of State For Alarm 5	
Dec	7582	23966	47932	RW	0	Do Not Record Alarm 5
Hex	1D9E	5D9E	BB3C		1	Record Alarm 5
Record Alarm 6 Status				Value	Record Change Of State For Alarm 6	
Dec	7615	23999	47998	RW	0	Do Not Record Alarm 6
Hex	1DBF	5DBF	BB7E		1	Record Alarm 6
Record Alarm 7 Status				Value	Record Change Of State For Alarm 7	
Dec	7616	24000	48000	RW	0	Do Not Record Alarm 7
Hex	1DC0	5DC0	BB80		1	Record Alarm 7
Record Power				Value	Record Instrument Power Turned On/Off	
Dec	7583	23967	47934	RW	0	Do Not Record Power On/Off
Hex	1D9F	5D9F	BB3E		1	Record Power On/Off
Record Cascade Master PV				Value	Record Cascade Mode Master Process Value	
Dec	7530	23914	47828	RW	0	Do Not Record PV
Hex	1D6A	5D6A	BAD4		1	Record PV Value Of Master
Record Cascade Master SP				Value	Record Cascade Mode Master Setpoint	
Dec	7531	23915	47830	RW	0	Do Not Record SP
Hex	1D6B	5D6B	BAD6		1	Record SP Value Of Master
Record Cascade Slave PV				Value	Record Cascade Mode Slave Process Value	
Dec	7532	23916	47832	RW	0	Do Not Record PV
Hex	1D6C	5D6C	BAD8		1	Record PV Value Of Slave

Record Cascade Slave Primary Power				Value	Record Primary Power Value of Cascade Slave	
Dec	7533	23917	47834	RW	0	Do Not Record Primary Power
Hex	1D6D	5D6D	BADA		1	Record Primary Power Of Slave
Record Slave Secondary Power				Value	Record Slave Secondary Power in Cascade Mode	
Dec	7538	23922	47844	RW	0	Do Not Record Secondary Power
Hex	1D72	5D72	BAE4		1	Record Secondary Power Of Slave
Record Ratio PV Input 1				Value	Record Ratio Mode Input 1 Process Value	
Dec	7534	23918	47836	RW	0	Do Not Record PV
Hex	1D6E	5D6E	BADC		1	Record Ratio Input 1 PV Value
Record Ratio PV Input 2				Value	Record Ratio Mode Input 2 Process Value	
Dec	7535	23919	47838	RW	0	Do Not Record PV
Hex	1D6F	5D6F	BADE		1	Record Ration Input 2 PV Value
Record Ratio SP				Value	Record Ratio Mode Setpoint	
Dec	7536	23920	47840	RW	0	Do Not Record SP
Hex	1D70	5D70	BAE0		1	Record Ratio Mode SP Value
Record Ratio Power				Value	Record Ratio Mode Power Output Value	
Dec	7537	23921	47842	RW	0	Do Not Record Ratio Power
Hex	1D71	5D71	BAE2		1	Record Ratio Mode Power
Trigger Recording On Alarm 1				Value	Alarm 1 To Trigger Recording	
Dec	7584	23968	47936	RW	0	Off
Hex	1DA0	5DA0	BB40		1	Trigger On Alarm 1 (if auto-trigger = profile or alarm)
Trigger Recording On Alarm 2				Value	Alarm 2 To Trigger Recording	
Dec	7685	24069	48138	RW	0	Off
Hex	1E05	5E05	BC0A		1	Trigger On Alarm 2 (if auto-trigger = profile or alarm)
Trigger Recording On Alarm 3				Value	Alarm 3 To Trigger Recording	
Dec	7686	24070	48140	RW	0	Off
Hex	1E06	5E06	BC0C		1	Trigger On Alarm 3 (if auto-trigger = profile or alarm)
Trigger Recording On Alarm 4				Value	Alarm 4 To Trigger Recording	
Dec	7687	24071	48142	RW	0	Off
Hex	1E07	5E07	BC0E		1	Trigger On Alarm 4 (if auto-trigger = profile or alarm)
Trigger Recording On Alarm 5				Value	Alarm 5 To Trigger Recording	
Dec	7688	24072	48144	RW	0	Off
Hex	1E08	5E08	BC10		1	Trigger On Alarm 5 (if auto-trigger = profile or alarm)
Trigger Recording On Alarm 6				Value	Alarm 6 To Trigger Recording	
Dec	7613	23997	47994	RW	0	Off
Hex	1DBD	5DBD	BB7A		1	Trigger On Alarm 6 (if auto-trigger = profile or alarm)
Trigger Recording On Alarm 7				Value	Alarm 7 To Trigger Recording	
Dec	7614	23998	47996	RW	0	Off
Hex	1DBE	5DBE	BB7C		1	Trigger On Alarm 7 (if auto-trigger = profile or alarm)
Sample Size				Data Recording Sample Size		
Dec	7595	23979	47958	RO	The size (in bytes) for recording sample with current settings	
Hex	1DAB	5DAB	BB56			

Record Event 1				Value	Record Change Of State For Event 1
Dec	7599	23983	47966	RW	0 Do Not Record Event 1
Hex	1DAF	5DAF	BB5E		1 Record Event 1
Record Event 2				Value	Record Change Of State For Event 2
Dec	7600	23984	47968	RW	0 Do Not Record Event 2
Hex	1DB0	5DB0	BB60		1 Record Event 2
Record Event 3				Value	Record Change Of State For Event 3
Dec	7601	23985	47970	RW	0 Do Not Record Event 3
Hex	1DB1	5DB1	BB62		1 Record Event 3
Record Event 4				Value	Record Change Of State For Event 4
Dec	7602	23986	47972	RW	0 Do Not Record Event 4
Hex	1DB2	5DB2	BB64		1 Record Event 4
Record Event 5				Value	Record Change Of State For Event 5
Dec	7603	23987	47974	RW	0 Do Not Record Event 5
Hex	1DB3	5DB3	BB66		1 Record Event 5
Memory Used				Percentage Data Recorder Memory Used	
Dec	7605	23989	47978	RO	Recorder Memory Used. 0 (Empty) to 100% (Full)
Hex	1DB5	5DB5	BB6A		
Date format				Value	Display Date Format
Dec	7868	24252	48504	RW	0 dd/mm/yyyy (European Default)
Hex	1EBC	5EBC	BD78		1 mm/dd/yyyy (USA Default)
Clock Time				Real Time Clock Time Of Day Setting	
Dec	7869	24253	48506	RW	Format is the number of seconds since midnight.
Hex	1EBD	5EBD	BD7A		
Clock Date				Real Time Clock Date Setting	
Dec	n/a	n/a	48508	RW	This can be entered only as a floating point number. When converted to binary the least significant 19 bits represent the date in this format:
Hex	n/a	n/a	BD7C		
<p>www DDDDD MMMM YYYYYYY YYYYYYY = YEAR MMMM = MONTH DDDDD = DAY OF MONTH (1-31 but must be valid) www = Day of the week The day of week portion is calculated from the date (<i>Read Only</i>).</p> <p>Example with date set to 31/07/2012 Day (31) = 11111 Month (7) = 0111 Year (12) = 0001100 Bits 17 and higher are ignored when writing so 11111 0111 0001100 (64396 decimal) is just one of many possible numbers to write as 31/07/2012, and when reading the date back, the number returned is 10 11111 0111 0001100 (195468 decimal) because bits 17-19 are 010 (to represent "Tuesday").</p>					

Real Time Clock Fitted				Value	Real Time Clock Fitted	
Dec	7871	24255	48510	RO	0	Not Fitted
Hex	1EBF	5EBF	BD7E		1	Fitted
Day Of The Week				Value	Day Of Week (calculated from clock date setting)	
Dec	7872	24256	48512	RO	1	Monday
Hex	1EC0	5EC0	BD80		2	Tuesday
					3	Wednesday
					4	Thursday
					5	Friday
					6	Saturday
					7	Sunday

Display & Security

Parameter Name & Register Address							
	Integer	Int +1	Float	Access	Values	& Descriptions	
LED 1 Label							
Dec	7656	24040	48080	RW			
Hex	1DE8	5DE8	BBD0				
LED 1 Alternate Label							
Dec	7660	24044	48088	RW			
Hex	1DEC	5DEC	BBD8				
LED 2 Label							
Dec	7657	24041	48082	RW			
Hex	1DE9	5DE9	BBD2				
LED 2 Alternate Label							
Dec	7661	24045	48090	RW		Labels shown in display immediately below the 4 red LED indicators. With up to 5 ASCII characters, which can read or written using Modbus functions 16 or 23. Valid characters are 0 to 9, a to z, A to Z, plus ß ö () - and _ . Defaults: 1 = PRI (Primary); 2 = SEC (Secondary); 3 = TUNE (Tuning); 4 = ALARM (Alarm)	
Hex	1DED	5DED	BBDA				
LED 3 Label							
Dec	7658	24042	48084	RW			
Hex	1DEA	5DEA	BBD4				
LED 3 Alternate Label							
Dec	7662	24046	48092	RW			
Hex	1DEE	5DEE	BBDC				
LED 4 Label							
Dec	7659	24043	48086	RW			
Hex	1DEB	5DEB	BBD6				
LED 4 Alternate Label							
Dec	7663	24047	48094	RW			
Hex	1DEF	5DEF	BBDE				

LED 1 Usage				Value	LED 1 Usage. For 8 & 9 see also LED 1 Selections.	
Dec	7664	24048	48096	RW	0	Loop 1 Primary Control ON = LED 1 ON
Hex	1DF0	5DF0	BBE0		1	Loop 1 Secondary Control ON = LED 1 ON
					2	Loop 2 Primary Control ON = LED 1 ON
					3	Loop 2 Secondary Control ON = LED 1 ON
					4	Loop 1 VMD Open ON = LED 1 ON
					5	Loop 1 VMD Close ON = LED 1 ON
					6	Loop 2 VMD Open ON = LED 1 ON
					7	Loop 2 VMD Close ON = LED 1 ON
					8	Alarm/Event/Digital/Control (Logical OR)
					9	Alarm/Event/Digital/Control inverted (Logical NOR)
<p>Value 8 (Logical OR selection of Alarm/Events/Digital/Control) turns ON the LED if <u>any</u> of the selected alarms, events, inputs or functions are active.</p> <p>Value 9 (Logical NOR selection of Alarm/Events/Digital/Control) turns OFF the LED if any of the selected alarms, events, inputs or functions are active.</p> <p>Note: Pre-tune will flash the LED instead of turning it on, but flashing will be obscured if used in conjunction with other functions when they are on.</p>						
LED 1 Alarm Indication				Bit	If bit =1, Alarm n status is selected	
Dec	7690	24074	48148	RW	0	Alarm 1
Hex	1E0A	5E0A	BC14		1	Alarm 2
					2	Alarm 3
					3	Alarm 4
					4	Alarm 5
					5	Alarm 6
					6	Alarm 7
LED 1 Profiler Event Indication				Bit	If bit =1, Event n status is selected	
Dec	7692	24076	48152	RW	0	Event 1
Hex	1E0C	5E0C	BC18		1	Event 2
					2	Event 3
					3	Event 4
					4	Event 5
					5	Profile Running
					6	Profile End
LED 1 Slot A & Soft Input Indication				Bit	If bit =1, Digital A / Soft Input n status is selected	
Dec	7694	24078	48156	RW	0	Digital Input A
Hex	1E0E	5E0E	BC1C		1	Soft Digital 1
					2	Soft Digital 2
					3	Soft Digital 3
					4	Soft Digital 4

LED 1 Option C Digital Indication				Bit	If bit =1, Digital Cn status is selected	
Dec	7696	24080	48160	RW	0	Digital Input C1
Hex	1E10	5E10	BC20		1	Digital Input C2
					2	Digital Input C3
					3	Digital Input C4
					4	Digital Input C5
					5	Digital Input C6
					6	Digital Input C7
LED 1 Control Indication				Bit	If bit =1, the function's status is selected	
Dec	7644	24028	48056	RW	0	Loop 1 Auto Tune (self-tune=On, pre-tune=flashing)
Hex	1DDC	5DDC	BBB8		1	Loop 1 Manual Control
					2	Loop 2 Auto Tune (self-tune=On, pre-tune=flashing)
					3	Loop 2 Manual Control
LED 2 Usage				Value	LED 2 Usage. For 8 & 9 see also LED 2 Selections.	
Dec	7665	24049	48098	RW	0	Loop 1 Primary Control ON = LED 1 ON
Hex	1DF1	5DF1	BBE2		1	Loop 1 Secondary Control ON = LED 1 ON
					2	Loop 2 Primary Control ON = LED 1 ON
					3	Loop 2 Secondary Control ON = LED 1 ON
					4	Loop 1 VMD Open ON = LED 1 ON
					5	Loop 1 VMD Close ON = LED 1 ON
					6	Loop 2 VMD Open ON = LED 1 ON
					7	Loop 2 VMD Close ON = LED 1 ON
					8	Alarm/Events/Digital/Control (Logical OR of selection below)
					9	Alarm/Events/Digital/Control inverted (Logical NOR of selection)

Value 8 (Logical **OR** selection of Alarm/Events/Digital/Control) turns **ON** the LED if any of the selected alarms, events, inputs or functions are active.
 Value 9 (Logical **NOR** selection of Alarm/Events/Digital/Control) turns **OFF** the LED if any of the selected alarms, events, inputs or functions are active.
Note: Pre-tune will flash the LED instead of turning it on, but flashing will be obscured if used in conjunction with other functions when they are on.

LED 2 Alarm Indication				Bit	If bit =1, Alarm n status is selected	
Dec	7698	24082	48164	RW	0	Alarm 1
Hex	1E12	5E12	BC24		1	Alarm 2
					2	Alarm 3
					3	Alarm 4
					4	Alarm 5
					5	Alarm 6
					6	Alarm 7

LED 2 Event Indication				Bit	If bit =1, Event <i>n</i> status is selected	
Dec	7700	24084	48168	RW	0	Event 1
Hex	1E14	5E14	BC28		1	Event 2
					2	Event 3
					3	Event 4
					4	Event 5
					5	Profile Running
					6	Profile End
LED 2 Slot A & Soft Input Indication				Bit	If bit =1, Digital A / Soft Input <i>n</i> status is selected	
Dec	7702	24086	48172	RW	0	Digital Input A
Hex	1E16	5E16	BC2C		1	Soft Digital 1
					2	Soft Digital 2
					3	Soft Digital 3
					4	Soft Digital 4
LED 2 Option C Digital Indication				Bit	If bit =1, Digital C <i>n</i> status is selected	
Dec	7704	24088	48176	RW	0	Digital Input C1
Hex	1E18	5E18	BC30		1	Digital Input C2
					2	Digital Input C3
					3	Digital Input C4
					4	Digital Input C5
					5	Digital Input C6
					6	Digital Input C7
LED 2 Control Indication				Bit	If bit =1, the function's status is selected	
Dec	7646	24030	48060	RW	0	Loop 1 Auto Tune (self-tune=On, pre-tune=flashing)
Hex	1DDE	5DDE	BBBC		1	Loop 1 Manual Control
					2	Loop 2 Auto Tune (self-tune=On, pre-tune=flashing)
					3	Loop 2 Manual Control
LED 3 Usage				Value	LED 3 Usage. For 8 & 9 see also LED 3 Selections.	
Dec	7666	24050	48100	RW	0	Loop 1 Primary Control ON = LED 1 ON
Hex	1DF2	5DF2	BBE4		1	Loop 1 Secondary Control ON = LED 1 ON
					2	Loop 2 Primary Control ON = LED 1 ON
					3	Loop 2 Secondary Control ON = LED 1 ON
					4	Loop 1 VMD Open ON = LED 1 ON
					5	Loop 1 VMD Close ON = LED 1 ON
					6	Loop 2 VMD Open ON = LED 1 ON
					7	Loop 2 VMD Close ON = LED 1 ON
					8	Alarm/Events/Digital/Control (Logical OR of selection below)
					9	Alarm/Events/Digital/Control inverted (Logical NOR of selection)

Value 8 (Logical **OR** selection of Alarm/Events/Digital/Control) turns **ON** the LED if any of the selected alarms, events, inputs or functions are active.

Value 9 (Logical **NOR** selection of Alarm/Events/Digital/Control) turns **OFF** the LED if any of the selected alarms, events, inputs or functions are active.

Note: Pre-tune will flash the LED instead of turning it on, but flashing will be obscured if used in conjunction with other functions when they are on.

LED 3 Alarm Indication				Bit	If bit =1, Alarm <i>n</i> status is selected	
Dec	7706	24090	48180	RW	0	Alarm 1
Hex	1E1A	5E1A	BC34		1	Alarm 2
					2	Alarm 3
					3	Alarm 4
					4	Alarm 5
					5	Alarm 6
					6	Alarm 7
LED 3 Event Indication				Bit	If bit =1, Event <i>n</i> status is selected	
Dec	7708	24092	48184	RW	0	Event 1
Hex	1E1C	5E1C	BC38		1	Event 2
					2	Event 3
					3	Event 4
					4	Event 5
					5	Profile Running
					6	Profile End
LED 3 Slot A & Soft Input Indication				Bit	If bit =1, Digital A / Soft Input <i>n</i> status is selected	
Dec	7710	24094	48188	RW	0	Digital Input A
Hex	1E1E	5E1E	BC3C		1	Soft Digital 1
					2	Soft Digital 2
					3	Soft Digital 3
					4	Soft Digital 4
LED 3 Option C Digital Indication				Bit	If bit =1, Digital C<i>n</i> status is selected	
Dec	7712	24096	48192	RW	0	Digital Input C1
Hex	1E20	5E20	BC40		1	Digital Input C2
					2	Digital Input C3
					3	Digital Input C4
					4	Digital Input C5
					5	Digital Input C6
					6	Digital Input C7
LED 3 Control Indication				Bit	If bit =1, the function's status is selected	
Dec	7648	24032	48064	RW	0	Loop 1 Auto Tune (self-tune=On, pre-tune=flashing)
Hex	1DE0	5DE0	BBC0		1	Loop 1 Manual Control
					2	Loop 2 Auto Tune (self-tune=On, pre-tune=flashing)
					3	Loop 2 Manual Control
LED 4 Usage				Value	LED 4 Usage. For 8 & 9 see also LED 4 Selections.	
Dec	7667	24051	48102	RW	0	Loop 1 Primary Control ON = LED 1 ON
Hex	1DF3	5DF3	BBE6		1	Loop 1 Secondary Control ON = LED 1 ON
					2	Loop 2 Primary Control ON = LED 1 ON
					3	Loop 2 Secondary Control ON = LED 1 ON
					4	Loop 1 VMD Open ON = LED 1 ON
					5	Loop 1 VMD Close ON = LED 1 ON
					6	Loop 2 VMD Open ON = LED 1 ON
					7	Loop 2 VMD Close ON = LED 1 ON
					8	Alarm/Events/Digital/Control (Logical OR of selection below)

9					Alarm/Events/Digital/Control inverted (Logical NOR of selection)
<p>Value 8 (Logical OR selection of Alarm/Events/Digital/Control) turns ON the LED if <u>any</u> of the selected alarms, events, inputs or functions are active.</p> <p>Value 9 (Logical NOR selection of Alarm/Events/Digital/Control) turns OFF the LED if any of the selected alarms, events, inputs or functions are active.</p> <p>Note: Pre-tune will flash the LED instead of turning it on, but flashing will be obscured if used in conjunction with other functions when they are on.</p>					
LED 4 Alarm Indication				Bit	If bit =1, Alarm <i>n</i> status is selected
Dec	7714	24098	48196	RW	0 Alarm 1
Hex	1E22	5E22	BC44		1 Alarm 2
					2 Alarm 3
					3 Alarm 4
					4 Alarm 5
					5 Alarm 6
					6 Alarm 7
LED 4 Event Indication				Bit	If bit =1, Event <i>n</i> status is selected
Dec	7716	24100	48200	RW	0 Event 1
Hex	1E24	5E24	BC48		1 Event 2
					2 Event 3
					3 Event 4
					4 Event 5
					5 Profile Running
					6 Profile End
LED 4 Slot A & Soft Input Indication				Bit	If bit =1, Digital A / Soft Input <i>n</i> status is selected
Dec	7718	24102	48204	RW	0 Digital Input A
Hex	1E26	5E26	BC4C		1 Soft Digital 1
					2 Soft Digital 2
					3 Soft Digital 3
					4 Soft Digital 4
LED 4 Option C Digital Indication				Bit	If bit =1, Digital <i>Cn</i> status is selected
Dec	7720	24104	48208	RW	0 Digital Input C1
Hex	1E28	5E28	BC50		1 Digital Input C2
					2 Digital Input C3
					3 Digital Input C4
					4 Digital Input C5
					5 Digital Input C6
					6 Digital Input C7
LED 4 Control Indication				Bit	If bit =1, the function's status is selected
Dec	7650	24034	48068	RW	0 Loop 1 Auto Tune (self-tune=On, pre-tune=flashing)
Hex	1DE2	5DE2	BBC4		1 Loop 1 Manual Control
					2 Loop 2 Auto Tune (self-tune=On, pre-tune=flashing)
					3 Loop 2 Manual Control

Backlight Colour				Value	Display Backlight Colour	
Dec	7668	24052	48104	RW	0	Green to Red if any output is latched
Hex	1DF4	5DF4	BBE8		1	Red to Green if any output is latched
					2	Green to Red if any alarm active
					3	Red to Green if any alarm active
					4	Permanent Green
					5	Permanent Red
Display Language				Value	Select Display Language	
Dec	7675	24059	48118	RW	0	Main Display Language
Hex	1DFB	5DFB	BBF6		1	Alternate Display Language
Display Contrast				Display Contrast Value		
Dec	7676	24060	48120	RW	Screen contrast adjustment to improve clarity. 10 to 100 with 100 = maximum contrast.	
Hex	1DFC	5DFC	BBF8			
Invert Display				Value	Normal Or Inverted Display	
Dec	7677	24061	48122	RW	0	Normal Display
Hex	1DFD	5DFD	BBFA		1	Inverted Display
Setup Lock Code				Setup Mode Entry Passcode		
Dec	7678	24062	48124	RW	1 to 9999. Default is 10	
Hex	1DFE	5DFE	BBFC			
Configuration Lock Code				Configuration Mode Entry Passcode		
Dec	7679	24063	48126	RW	1 to 9999. Default is 10	
Hex	1DFF	5DFF	BBFE			
Tuning Lock Code				Automatic Tuning Mode Entry Passcode		
Dec	7680	24064	48128	RW	1 to 9999. Default is 10	
Hex	1E00	5E00	BC00			
Supervisor Lock Code				Supervisor Mode Entry Passcode		
Dec	7681	24065	48130	RW	1 to 9999. Default is 10	
Hex	1E01	5E01	BC02			
Profiler Setup Lock Code				Profiler Setup Mode Entry Passcode		
Dec	7682	24066	48132	RW	1 to 9999. Default is 10	
Hex	1E02	5E02	BC04			
USB Lock Code				USB Mode Entry Passcode		
Dec	7683	24067	48134	RW	1 to 9999. Default is 10	
Hex	1E03	5E03	BC06			
Recorder Lock Code				Recorder Control Mode Entry Passcode		
Dec	7684	24068	48136	RW	1 to 9999. Default is 10	
Hex	1E04	5E04	BC08			
Profile Control Lock Code				Profile Control Mode Entry Passcode		
Dec	7688	24072	48144	RW	1 to 9999. Default is 10	
Hex	1E08	5E08	BC10			
Read Only Operation Mode				Value	Read Only Operation Mode	
Dec	7685	24069	48138	RW	0	Operation Mode Read/Write
Hex	1E05	5E05	BC0A		1	Operation Mode Read Only

Loop 1 Trend View Sample Rate				Value	Trend Sample Interval For Loop 1	
Dec	9000	25384	50768	RW	0	Every Second
Hex	2328	6328	C650		1	Every 2 Seconds
					2	Every 5 Seconds
					3	Every 10 Seconds
					4	Every 15 Seconds
					5	Every 30 Seconds
					6	Every Minute
					7	Every 2 Minutes
					8	Every 5 Minutes
					9	Every 10 Minutes
					10	Every 15 Minutes
					11	Every 30 Minutes
Loop 1 Trend View Data				Value	Values To Display In Loop 1 Trend View	
Dec	9001	25385	50770	RW	1	Process variable only
Hex	2329	6329	C652		2	Process variable and setpoint
					3	Max & min process value since last sample
Loop 1 Trend View in Operator Mode				Value	Trend View For Loop 1 Visible In Operator Mode	
Dec	9007	25391	50782	RW	0	No
Hex	232F	632F	C65E		1	Yes
Loop 2 Trend View Sample Rate				Value	Trend Sample Interval For Loop 2	
Dec	9010	25394	50788	RW	0	Every Second
Hex	2332	6332	C664		1	Every 2 Seconds
					2	Every 5 Seconds
					3	Every 10 Seconds
					4	Every 15 Seconds
					5	Every 30 Seconds
					6	Every Minute
					7	Every 2 Minutes
					8	Every 5 Minutes
					9	Every 10 Minutes
					10	Every 15 Minutes
					11	Every 30 Minutes
Loop 2 Trend View Data				Value	Values To Display In Loop 2 Trend View	
Dec	9011	25395	50790	RW	1	Process variable only
Hex	2333	6333	C666		2	Process variable and setpoint
					3	Max & min process value since last sample
Loop 1 Trend View in Operator Mode				Value	Trend View For Loop 2 Visible In Operator Mode	
Dec	9017	25401	50802	RW	0	No
Hex	2339	6339	C672		1	Yes

Instrument Data Parameters

Parameter Name & Register Address						
	Integer	Int +1	Float	Access	Values & Descriptions	
Serial Number 1				Serial Number (part 1)		
Dec	210	16594	33188	RO	The first 4 digits of the instrument's Serial number.	
Hex	00D2	40D2	81A4			
Serial Number 2				Serial Number (part 2)		
Dec	211	16595	33190	RO	The digits 5 to 8 of the instrument's Serial number.	
Hex	00D3	40D3	81A6			
Serial Number 3				Serial Number (part 3)		
Dec	212	16596	33192	RO	The digits 9 to 11 of the instrument's Serial number.	
Hex	00D4	40D4	81A8			
Serial Number 4				Serial Number (part 4)		
Dec	213	16597	33194	RO	The digits 12 to 14 of the instrument's Serial number.	
Hex	00D5	40D5	81AA			
Manufacture Day				Day Of Manufacture		
Dec	370	16754	33508	RO	Date of manufacture – 1 to 31 (day of month)	
Hex	0172	4172	82E4			
Manufacture Month				Month Of Manufacture		
Dec	371	16755	33510	RO	Month of manufacture – 1 to 12	
Hex	0173	4173	82E6			
Manufacture Year				Year Of Manufacture		
Dec	372	16756	33512	RO	4 digit number = Year of manufacture (e.g. 2013)	
Hex	0174	4174	82E8			
USB Option Fitted				Value	USB Option	
Dec	7503	23887	47774	RO	0	Not Fitted
Hex	1D4F	5D4F	BA9E		1	Fitted
Data Recorder Fitted				Value	Data Recorder Fitted	
Dec	7553	23937	47874	RO	0	Not Fitted
Hex	1D81	5D81	BB02		1	Fitted
Profiler Enabled				Value	Profiler Feature Enabled	
Dec	8199	24583	49166	RO	0	Profiler Not Enabled
Hex	2007	6007	C00E		1	Profiler Enabled
Software PRL				Product Revision Level (Firmware)		
Dec	208	16592	33184	RO	Product Revision Level – Firmware Level. Manufacturer assigned number, incremented with each firmware code update.	
Hex	00D0	40D0	81A0			
Hardware PRL				Product Revision Level (Hardware)		
Dec	207	16591	33182	RO	Product Revision Level – Hardware Level. Manufacturer assigned number, incremented with each hardware change.	
Hex	00CF	40CF	819E			
Firmware Type				Product Firmware Type		
Dec	217	16601	33202	RO	Product Firmware Type Reference Number	
Hex	00D9	40D9	81B2			
Firmware Version				Product Firmware Version		
Dec	218	16602	33204	RO	Revision number of installed firmware	
Hex	00DA	40DA	81B4			

Contact Details 1					"For Service" Contact Details - Lines 1 to 7				
Dec	400	16784	33568	RW	<p>7 lines of user definable text - 25 ASCII characters per line which can be read or written using Modbus functions 16 or 23.</p> <p>Note: The number of ASCII characters transmitted per line must be EVEN. If the text string you wish to send has an odd number, place an additional space character at the end. The space character is 20 hex.</p> <p>Valid characters are 0 to 9, a to z, A to Z, plus ß ö () - and _.</p> <p>Example. To write "My Company Name" to line 1 send: [ADDRESS], 16, 01, 90, 00, 08, 10, 4D, 79, 20, 43, 6F, 6D, 70, 61, 6E, 79, 20, 4E, 61, 6D, 65, 20, [CRC]</p>				
Hex	0190	4190	8320						
Contact Details 2									
Dec	401	16785	33570	RW					
Hex	0191	4191	8322						
Contact Details 3									
Dec	402	16786	33572	RW					
Hex	0192	4192	8324						
Contact Details 4									
Dec	403	16787	33574	RW					
Hex	0193	4193	8326						
Contact Details 5									
Dec	404	16788	33576	RW					
Hex	0194	4194	8328						
Contact Details 6									
Dec	405	16789	33578	RW					
Hex	0195	4195	832A						
Contact Details 7									
Dec	406	16790	33580	RW					
Hex	0196	4196	832C						

Profiler Control & Status Parameters

Parameter Name & Register Address							
	Integer	Int +1	Float	Access	Values	& Descriptions	
Active Profiler				Active Profiler Number			
Dec	8243	24627	49254	RW	Currently selected profile number (0 to 63)		
Hex	2033	6033	C066				
Active Segment				Active Segment Number			
Dec	8244	24628	49256	RO	The active segment number (1 to 255) of the selected profile.		
Hex	2034	6034	C068				
Profiler Control Commands				Value	Profiler Command		
Dec	8245	24629	49258	RW	0	Do nothing	
Hex	2035	6035	C06A		1	Run the currently selected profile	
					2	Hold the currently running profile	
					3	Abort the currently running profile	
					4	Jump to the next segment	
					5	Release the hold	
					6	Exit profiler, return to controller mode	
					8	Select a profile to be run but not start it	
Profiler Control Confirmation Action				Value	Implement Profiler Command		
Dec	8257	24641	49282	RW	0	Do not Implement Command	
Hex	2041	6041	C082		1	Implement previous Profiler Command	
Enable Edit While Running				Value	Operator Editing of Current Running Profile		
Dec	8262	24646	49292	RW	0	Editing of running profile forbidden	
Hex	2046	6046	C08C		1	Editing of running profile via Keypad allowed	

Operator Access To Profile Control				Value	Profile Control From Operation Mode	
Dec	8260	24644	49288	RW	0	Operation Mode profile control disabled
Hex	2044	6044	C088		1	Operation Mode profile control enabled
Profile Cycles Run				Value	Profile Cycles Run Status	
Dec	8247	24631	49262	RO		The Number of times the currently running profile has cycled
Hex	2037	6037	C06E			
Event 1 Status				Value	Status Of Event 1	
Dec	8249	24633	49266	RO	0	Event 1 Inactive
Hex	2039	6039	C072		1	Event 1 Active
Event 2 Status				Value	Status Of Event 2	
Dec	8250	24634	49268	RO	0	Event 2 Inactive
Hex	203A	603A	C074		1	Event 2 Active
Event 3 Status				Value	Status Of Event 3	
Dec	8251	24635	49270	RO	0	Event 3 Inactive
Hex	203B	603B	C076		1	Event 3 Active
Event 4 Status				Value	Status Of Event 4	
Dec	8252	24636	49272	RO	0	Event 4 Inactive
Hex	203C	603C	C078		1	Event 4 Active
Event 5 Status				Value	Status Of Event 5	
Dec	8253	24637	49274	RO	0	Event 5 Inactive
Hex	203D	603D	C07A		1	Event 5 Active
Segment Type Status				Value	The Current Running Profile Segment Type	
Dec	8258	24642	49284	RO	0	No segment
Hex	2042	6042	C084		1	Setpoint ramping up
					2	Step
					3	Dwell
					4	Held
					5	Loop
					6	Join
					7	End
					8	Setpoint ramping down
Active Profile Name				Value	Name of Currently Selected Profile	
Dec	8259	24643	49286	RO		The name of the currently selected profile
Hex	2043	6043	C086			
Secondary Profile Status				Value	Secondary Profile Status of Selected Profile	
Dec	8232	24616	49232	RO	0	Profile running
Hex	2028	6028	C050		1	Input sensor break
					2	Profile not valid
					3	Controller in manual mode
					4	Profile finished and maintaining last profile setpoint
					5	Profile finished with control outputs off
				6	Profile control has ended. Unit is Controller Mode.	
Delay time				Value	Remaining Profile Delay Time	
Dec	8233	24617	49234	RO		The current start delay time remaining in seconds, before selected profile will begin.
Hex	2029	6029	C052			

Current Profile Running Time				Current Profile Running Time	
Dec	8235	24619	49238	RO	The elapsed time of the current running profile in seconds since it began running.
Hex	202B	602B	C056		
Current Profile Remaining Time				Current Profile Remaining Time	
Dec	8236	24620	49240	RO	The remaining time for the current running profile before reaching its end segment, in seconds
Hex	202C	602C	C058		
Current Segment Running Time				Current Segment Running Time	
Dec	8237	24621	49242	RO	The elapsed time of the current profile segment in seconds
Hex	202D	602D	C05A		
Current Segment Remaining Time				Current Segment Remaining Time	
Dec	8238	24622	49244	RO	The remaining time for the current profile segment in seconds
Hex	202E	602E	C05C		
Total Hold Time				Total Hold Time	
Dec	8239	24623	49246	RO	Total (accumulated) time the current profile has been held in seconds
Hex	202F	602F	C05E		
Current Segment Loops Run				Number of Current Segment Loop-backs	
Dec	8240	24624	49248	RO	The number of times the current looping segment has looped back
Hex	2030	6030	C060		
Profile Setup				Profile Setup via Modbus	
Dec	8198	24582	49164	RW	Note: Refer to the Profile Setup Over Modbus information below for setting up profiles via comms
Hex	2006	6006	C00C		

Profile Setup via Modbus

The information in this section is intended for advanced users writing their own software code. Most users will create or edit profiles using the instrument keypad, or using the the PC software (available from your supplier). Either method allows quick and easy editing of profiles.



Note: *There is a global block on profile creation or editing via Modbus while a profile is running. An attempt to do so returns the error code 0x15. The only profile related commands allowed while a profile runs are the Profile Control & Status Parameters in the previous section.*

Advanced users can setup or edit profiles by writing to the Profile Configuration parameter at address 8198 (0x2006). This can only be accessed by using Modbus function code 23 (0x17). The instrument replies with a status message.

When creating a new profile the steps below must be followed exactly, either to create a profile at the next available position, or at the position you specify.

Each message in the sequence includes a 2 byte Command Code that tells the instrument the purpose of the message, and therefore the meaning of the data contained in it.

Instruction Sequence to create a profile at the next available position

1. Create a profile by writing the profile header data using the Command Code value CP (0x43, 0x50). This starts the profile creation process by reserving a profile memory slot. The profile number is returned by the instrument in the Edit Response Message.

2. Write the first segment using the Command Code value Code WS (0x57, 0x53). This command will fill the next available segment position and link it to the profile created in step 1.
3. Write the second segment, again using Command Code WS. This fills the next available segment position and links it to the segment created in step 2.
4. Continue writing segments until the profile is complete (whilst remaining within the overall limit of 255 segments for all profiles combined). Each of these segments fills the next available position and links it to the previous segment specified.
5. The very last segment of the profile must be one of the end type segments. Thereafter, no more segments can be added to the specified profile. To add a segment to an existing profile the insert segment command must be used.

Instruction Sequence to create a profile at a specified profile position



CAUTION: If this profile number is already in use then the profile header data is overwritten but the segments associated with it are kept.

1. Determine which profile positions are being used by using the Command Code value PS (0x50, 0x53). This command will return a list of all the profile positions currently being used.
2. Choose a location that is not being used and write the profile header data using the Command Code value WP (0x57, 0x50).
The profile number is echoed back by the instrument in the Edit Response Message.
3. Write the first segment using the Command Code value Code WS (0x57, 0x53). This command will fill the next available segment position and link it to the profile created in step 1.
4. Write the second segment, again using Command Code WS. This fills the next available segment position and links it to the segment created in step 2.
5. Continue writing segments until the profile is complete (whilst remaining within the overall limit of 255 segments for all profiles combined). Each of these segments fills the next available position and links it to the previous segment specified.
6. The very last segment of the profile must be one of the end type segments. Thereafter, no more segments can be added to the specified profile. To add a segment to an existing profile the insert segment command must be used.

Instruction Sequence to edit an existing Profile Header

When a profile header is changed, the segments associated with it remain unchanged. They must be edited separately if required.

1. Determine the number of the profile to be edited. Use the Command Code value PS (0x50, 0x53) which returns a list of all profile positions/numbers currently in use.
2. Write a new profile header data using the Command Code value EP (0x45, 0x50).
The profile number is echoed back by the instrument in the Edit Response Message.

Instruction Sequence to read a profile

1. Use the command RP to read the profile header data
2. Use the command RS to read the 1st segment's data
3. Use the command RS to read the 2nd segment's data.
4. Repeat steps 2 and 3 until an end segment is reached.

The following rules apply when creating a profile over communications:

- Profiles must always be terminated with an end segment.
- Segments cannot be added after an end segment has been added.
- All changes made to the selected profile are immediately saved in the instrument.

Creating or Editing a Profile Header

Creating Or Editing A Profile Header - Request (to instrument)			
Field Name	Data		Comments
	Dec	Hex	
Unit Address	A/R	A/R	The network address ID of the instrument.
Function Code	23	17	Requires the multi read/write function.
Read Start Address High Byte	32	20	
Read Start Address Low Byte	6	6	
Read Quantity Of Registers High Byte	0	0	
Read Quantity Of Registers Low Byte	1	1	
Write Start Address High Byte	32	20	
Write Start Address Low Byte	6	6	
Write Quantity Of Registers High Byte	0	0	
Write Quantity Of Registers Low Byte	20 or 21	14 or 15	20dec / 0x14hex if creating a profile at the next available location. 21dec / 0x15hex if creating a profile at a specified location, or editing a profile.
Byte Count	40 or 42	28 or 2A	40dec / 0x28hex if creating a profile at the next available location. 42dec / 0x2Ahex if creating a profile at a specified location, or editing a profile.
Command Code High Byte	67, 69 or 87	43, 45 or 57	0x43hex (67dec) if creating a profile at the next available location. 45hex (69 dec) / 57hex (87dec) if creating a profile at a specified location, or editing a profile.
Command Code Low Byte	80	50	
Profile Number High Byte	A/R	A/R	Note: The profile number is not included in the message when creating a profile at the next available position.
Profile Number Low Byte	A/R	A/R	

Profile Name Character 1	A/R	A/R	<p>The ASCII codes equivalent to each of the 16 characters of the profile name, e.g.:</p> <p>A = 65dec / 0x41, B = 66dec / 0x42 etc. a = 97dec / 0x61, b = 98dec / 0x62 etc.</p> <p>Valid characters are 0 to 9, a to z, A to Z, plus ß ö () - and _.</p> <p>Note: Only valid characters from the instruments supported character set should be used The space character (32dec / 0x20hex) is used to fill any unused characters at the end of the name.</p>
Profile Name Character 2	A/R	A/R	
Profile Name Character 3	A/R	A/R	
Profile Name Character 4	A/R	A/R	
Profile Name Character 5	A/R	A/R	
Profile Name Character 6	A/R	A/R	
Profile Name Character 7	A/R	A/R	
Profile Name Character 8	A/R	A/R	
Profile Name Character 9	A/R	A/R	
Profile Name Character 10	A/R	A/R	
Profile Name Character 11	A/R	A/R	
Profile Name Character 12	A/R	A/R	
Profile Name Character 13	A/R	A/R	
Profile Name Character 14	A/R	A/R	
Profile Name Character 15	A/R	A/R	
Profile Name Character 16	A/R	A/R	
Profile Start Signal High Byte	0	0	0 = No delay, 1 = After delay, 2 = At Time/day *2 <i>only if recorder (RTC) fitted</i>
Profile Start Signal Low Byte	A/R	A/R	
Profile Start Time (Byte 4 - High)	A/R (Floating point number)	(Floating point number)	The time, in elapsed seconds from the start trigger, before a profile will begin if Start Signal =1 (After Delay) or seconds from midnight if Start Signal =2 (Time of Day) Use zero if Start Signal =0 (No Delay)
Profile Start Time (Byte 3)			
Profile Start Time (Byte 2)			
Profile Start Time (Byte 1 - Low)			
Profile Start Day High Byte	0	0	1 = Monday, 2 = Tuesday, 3 = Wednesday, 4 = Thursday, 5 = Friday, 6 = Saturday, 7 = Sunday, 8 = Monday to Friday, 9 = Monday to Saturday, 10 = Saturday And Sunday, 11= All Week. <i>Use 1 if no recorder fitted.</i>
Profile Start Day Low Byte	A/R	A/R	
Profile Starting Setpoint High	0	0	0 = Current Setpoint, 1 = Current Process Variable Value
Profile Starting Setpoint Low	A/R	A/R	
Profile Recovery High Byte	0	0	0 = Control to off, 1 = Restart profile, 2 = Maintain last profile setpoint, 3 = Use controller setpoint, 4 = Continue profile from where it was when power failed
Profile Recovery Low Byte	A/R	A/R	
Profile Recovery Time (Byte 4 - high)	A/R (Floating point number)	(Floating point number)	The Profile Recovery Time (before the recovery action will be used after power/signal returns). Entered as elapsed seconds. <i>Use zero if no recorder fitted.</i>
Profile Recovery Time (Byte 3)			
Profile Recovery Time (Byte 2)			
Profile Recovery Time (Byte 1 - Low)			
Profile Abort action High Byte	0	0	0 = Control to off, 1 = Maintain last profile setpoint, 2 = Use controller setpoint
Profile Abort Action Low Byte	A/R	A/R	
Profile Cycles High Byte	A/R	A/R	1 to 9999 or 10,000 for "Infinite"
Profile Cycles Low Byte	A/R	A/R	
Profile Number of Loops High Byte	0	0	The number of loops to be controlled by the profile: 1 or 2
Profile Number of Loops Low Byte	A/R	A/R	
CRC High Byte	A/R	A/R	
CRC Low Byte	A/R	A/R	

The instrument replies to this message with an Edit Response Message.

Creating, Editing or Inserting Segments

Creating new segments is only possible when a new profile is being created (see above for instruction for creating a profile at the next available position, or at a position that you specify). An error is returned if the correct sequence is not followed.

The Insert Segment command is used to add segments to an existing profile (one that already has an end segment). This inserts a new segment at the position specified.

The Edit Segment command is used to alter segments of an existing profile.

The segment number is in relation to the profile number, e.g. to edit or insert a segment at position 3 of profile 1 the segment number will be 3, and to edit or insert a segment at position 3 of profile 6 the segment number will also be 3.

Creating, Editing or Inserting Segments - Request (to instrument)			
Field Name	Data		Comments
	Dec	Hex	
Unit Address	A/R	A/R	The network address ID of the instrument.
Function Code	23	17	Requires the multi read/write function.
Read Start Address High Byte	32	20	
Read Start Address Low Byte	6	6	
Read Quantity Of Registers High	0	0	
Read Quantity Of Registers Low	1	1	
Write Start Address High	32	20	
Write Start Address Low	6	6	
Write Quantity Of Registers High	0	0	
Write Quantity Of Registers Low	16 or 17	10 or 11	Create Segment (WS) = 16dec / 0x10hex Insert Segment (IS) = 17dec / 0x11hex Edit A Segment (ES) = 17dec / 0x11hex
Byte Count	32 or 34	20 or 22	Create Segment (WS) = 32dec / 0x20hex Insert Segment (IS) = 34dec / 0x22hex Edit A Segment (ES) = 34dec / 0x22hex
Command Code High Byte	87, 69 or 73	57, 45 or 49	Create Segment (WS) = 87dec / 0x57hex Insert Segment (IS) = 73dec / 0x49hex Edit A Segment (ES) = 69dec / 0x45hex
Command Code Low Byte	83	53	
Profile Number High Byte	A/R	A/R	Profile number to place this segment in (IS, ES) or append to (WS)
Profile Number Low Byte	A/R	A/R	
Segment Position High Byte	A/R	A/R	Note: The Segment Position is not included in the message when creating a segment at the next available position.
Segment Position Low Byte	A/R	A/R	
Segment Type High Byte	0	0	0 = Ramp Time, 1 = Ramp Rate* 2 = Step, 3 = Dwell, 4 = Hold, 5 = Loop 6 = Join, 7 = End, 8 = Repeat sequence then end (*1 is not valid for 2 loop profiles)
Segment Type Low Byte	A/R	A/R	
Segment Info A (Byte 4 - High)	A/R (Floating point number)		The meaning of the data contained in Segment Info A depends on the type of segment it relates to. See below.
Segment Info A (Byte 3)			
Segment Info A (Byte 2)			
Segment Info A (Byte 1 - Low)			

Segment Info B (Byte 4 - High)	A/R (Floating point number)		The meaning of the data contained in Segment Info B depends on the type of segment it relates to. <i>See below.</i>
Segment Info B (Byte 3)			
Segment Info B (Byte 2)			
Segment Info B (Byte 1 - Low)			
Auto Hold Type Loop 1 High Byte	A/R	A/R	0 = Auto-Hold Off, 1 = Hold above SP, 2 = Hold below SP, 3 = Hold above and below SP
Auto Hold Type Loop 1 Low Byte	A/R	A/R	
Auto Hold Value Loop 1 (Byte 4 - High)	A/R (Floating point number)		The distance loop 1 can be way from setpoint before Auto-Hold activates.
Auto Hold Value Loop 1 (Byte 3)			
Auto Hold Value Loop 1 (Byte 2)			
Auto Hold Value Loop 1 (Byte 1 - Low)			
Events High Byte	0	0	The status of the five events are defined by the lowest 5 bits of the low byte. A bit value of 1 signifies the event is on. Bit 0 = event 1, bit 1 = event 2, bit 2 = event 3 bit 3 = event 4 and bit 4 = event 5.
Events Low Byte	A/R	A/R	
Segment Info B Loop 2 (Byte 4 - High)	A/R (Floating point number)		The meaning of the data contained in Segment Info B depends on the type of segment it relates to. <i>See below.</i> (write 0 for single loop profiles)
Segment Info B Loop 2 (Byte 3)			
Segment Info B Loop 2 (Byte 2)			
Segment Info B Loop 2 (Byte 1 - Low)			
Auto Hold Type Loop 2 High Byte	A/R	A/R	0 = Auto-Hold Off, 1 = Hold above SP, 2 = Hold below SP, 3 - Hold above and below SP (write 0 for single loop profiles).
Auto Hold Type Loop 2 Low Byte	A/R	A/R	
Auto Hold Value Loop 2 (Byte 4 - High)	A/R (Floating point number)		The distance loop 2 can be way from setpoint before Auto-Hold activates. (write 0 for single loop profiles).
Auto Hold Value Loop 2 (Byte 3)			
Auto Hold Value Loop 2 (Byte 2)			
Auto Hold Value Loop 2 (Byte 1 - Low)			
CRC High Byte	A/R	A/R	
CRC Low Byte	A/R	A/R	

Segment Data

The Segment Data is included in the command message when creating, editing or inserting segments (see above). It is provided in two parts (Segment Info A and B). The meaning of the data contained in Segment Info A and B depends on the type of segment it relates to. *Null* is shown for unused data, these data values should be set to zero when writing the segment data.

Segment Type	Segment Info		Description
	A	B	
Ramp Time	Time	Target setpoint	Ramp to the target setpoint "B" in the time "A"
Ramp Rate	Ramp rate	Target setpoint	Ramp to the target setpoint "B" at the ramp rate "A"
Step	<i>Null (0)</i>	Target setpoint	Step to a target setpoint "B"
Dwell	Dwell time	<i>Null (0)</i>	Stay at the current setpoint for a period of time "A"

Hold	0 = Operator	Null (0)	Wait for the operator to release the hold
	1 = Time of day	Start Time	Wait until time of the day "B" in seconds since midnight (<i>recorder only</i>).
	2 = Digital input	Null (0)	Wait for digital input signal
Loop	Number of times to repeat 1 to 9999	Segment number	Loop to the specified segment number "B" from this point. Repeat this "A" times. Note: <i>Only segments below the current segment can be entered. Two "loop-backs" must not cross each other.</i>
Join	Null (0)	Profile number	On completion of this profile jump run profile "B"
End	0 = Control off	Null (0)	Turn off all control outputs on the loop(s) controlled by the profile. Doesn't affect loop 2 on single loop profiles.
	1 = Maintain profile setpoint	Null (0)	Stay at the final setpoint of the profile
	2 = Use controller setpoint	Null (0)	Use the active controller setpoint (e.g. Main or Alternate as selected). This exits from Profiler Mode back to Controller Mode.
Repeat Sequence Then End	0 = Outputs off	Number of times to repeat sequence	Repeat the profile sequence number "B" times, then turn off the control outputs
	1 = Maintain profile setpoint		Repeat the profile sequence number "B" times, then hold the last profile setpoint.
	2 = Use controller setpoint		Repeat the profile sequence number "B" times, then use the active controller setpoint (e.g. Main or Alternate as selected). This exits from Profiler Mode back to Controller Mode.

The instrument replies to this message with an Edit Response Message.

Deleting All or Single Profiles

An individual profile can be deleted, or all profiles can be deleted with a single message. Deleting a profile removes the header of the specified profile and any segments associated with it. Delete all profiles wipes all profiles and segments from the instrument.

Delete Profiles - Request (to instrument)			
Field Name	Data		Comments
	Dec	Hex	
Unit Address	A/R	A/R	The network address ID of the instrument.
Function Code	23	17	Requires the multi read/write function
Read Start Address High Byte	32	20	
Read Start Address Low Byte	6	6	
Read Quantity Of Registers High	0	0	
Read Quantity Of Registers Low	1	1	
Write Start Address High	32	20	
Write Start Address Low	6	6	
Write Quantity Of Registers High	0	0	
Write Quantity Of Registers Low	02 or 01	02 or 01	Delete A Profile (DP) = 02dec / 0x02hex Delete All Profiles (DA) = 01dec / 0x01hex

Byte Count	04 or 02	04 or 02	Delete A Profile (DP) = 04dec / 0x04hex Delete All Profiles (DA) = 02dec / 0x02hex
Command Code High Byte	68	44	
Command Code Low Byte	80 or 65	50 or 41	Delete A Profile (DP) = 80dec / 0x50hex Delete All Profiles (DA) = 65dec / 0x41hex
Profile Number High Byte	A/R	A/R	Note: The profile number is not included in the message when deleting all profiles.
Profile Number Low Byte	A/R	A/R	
CRC High Byte	A/R	A/R	
CRC Low Byte	A/R	A/R	

The instrument replies to this message with an Edit Response Message.

Delete a Segment

The delete segment command deletes the specified segment from the specified profile. The following segments are moved up one place in the profile (e.g. if segment 6 is deleted segment 7 becomes segment 6).

Delete A Segment - Request (to instrument)			
Field Name	Data		Comments
	(Dec)	(Hex)	
Unit Address	A/R	A/R	The ID address of the instrument
Function Code	23	17	Requires the multi read/write function
Read Start Address High Byte	32	20	
Read Start Address Low Byte	6	6	
Read Quantity Of Registers High	0	0	
Read Quantity Of Registers Low	1	1	
Write Start Address High	32	20	
Write Start Address Low	6	6	
Write Quantity Of Registers High	0	0	
Write Quantity Of Registers Low	3	3	
Byte Count	6	6	
Command Code High Byte	68	44	
Command Code Low Byte	83	53	
Profile Number High Byte	A/R	A/R	
Profile Number Low Byte	A/R	A/R	
Segment Number High Byte	A/R	A/R	
Segment Number Low Byte	A/R	A/R	
CRC High Byte	A/R	A/R	
CRC Low Byte	A/R	A/R	

The instrument replies to this message with an Edit Response Message.

Get Segments Remaining

Returns the number of unused segments remaining in the instrument. The number will be between 0 and 255, depending on how many have been used in the profiles so far created.

Get Segments Remaining - Request (to instrument)			
Field Name	Data		Comments
	Dec	Hex	
Unit Address	A/R	A/R	The ID address of the instrument as required
Function Code	23	17	Requires the multi read/write function
Read Start Address High Byte	32	20	
Read Start Address Low Byte	6	6	
Read Quantity Of Registers High	0	0	
Read Quantity Of Registers Low	1	1	
Write Start Address High	32	20	
Write Start Address Low	6	6	
Write Quantity Of Registers High	0	0	
Write Quantity Of Registers Low	1	1	
Byte Count	2	2	
Command Code High Byte	83	53	
Command Code Low Byte	82	52	
CRC High Byte	A/R	A/R	
CRC Low Byte	A/R	A/R	

The instrument replies to this message with an Edit Response Message.

Edit Response Message from Instrument

The instrument replies to each profile or segment creation, edit or delete message with an Edit Response Message. The same format is used when replying to the Get Segments Remaining request.

Edit Response Message - Response (from instrument)			
Field Name	Data		Comments
	Dec	Hex	
Unit Address	A/R	A/R	The ID address of the instrument
Function Code	23	17	The multi read/write function
Byte Count	2	2	
Command Response High Byte	A/R	A/R	<i>Two data bytes containing the Command Response data (see below)</i>
Command Response Low Byte	A/R	A/R	
CRC High Byte	A/R	A/R	
CRC Low Byte	A/R	A/R	

Command Response Data

The data contained in the Edit Response Message returned after each profile or segment edit message is shown below. The data seen can be an error code, the number of unused segments or the profile number following a successful profile header creation/edit. The error code shown will be as appropriate for the request message and instrument status.

Command Response Name	Response		Description
	Low Byte	High Byte	
Profile Number	A/R	A/R	The number of the profile created or edited
Segments Remaining	A/R	A/R	The number of unused segments remaining
Command Successfully	0x4F	0x4B	The command requested was executed without error
Command Not Recognized	0xFF	0xFF	The command is not recognized
Profile Number Invalid	0xF0	0x00	The profile number specified is not available.
Profile Name Invalid	0xF0	0x01	The profile name/characters are not valid
Start Signal Invalid	0xF0	0x02	The start signal is not recognized
Start Time Invalid	0xF0	0x03	The specified time is not within range
Start Day Invalid	0xF0	0x04	The specified day is not recognized
Starting Setpoint Invalid	0xF0	0x05	The specified starting setpoint is not recognized
Profile Recovery Invalid	0xF0	0x06	The profile recovery is not recognized
Recovery Time Invalid	0xF0	0x07	The recovery time is not within limits
Abort Action Invalid	0xF0	0x08	The abort action is not recognized
Profile Cycles Invalid	0xF0	0x09	The number of profile cycles is not within limits
Segment Number Invalid	0xF0	0x0A	The segment number is not valid for this profile
Segment Type Invalid	0xF0	0x0B	The segment type is not recognized
Segment Info A Invalid	0xF0	0x0C	Segment information A not valid for the type defined
Segment Info B Invalid	0xF0	0x0D	Segment information B is not valid for the type defined
Loop 1 Auto Hold Type Invalid	0xF0	0x0E	The auto hold type is not recognized
Loop 1 Auto Hold Value Invalid	0xF0	0x16	The auto hold value is not within input span
Events Value Invalid	0xF0	0x10	The events are not within range
No Segments Remaining	0xF0	0x11	There are no more segments available
Write Length Invalid	0xF0	0x12	The number of parameters to be written are invalid for the function requested
Segment Setpoint Clamped	0xF0	0x13	The setpoint value entered was out of bounds. It has been clamped within the units setpoint limits.
Segment Not Written	0xF0	0x14	The segment has not been written
Profiler Running	0xF0	0x15	The profiler is currently running so cannot be edited
Loop 2 Auto Hold Value Invalid	0xF0	0x17	The auto hold type is not recognized
Invalid number of loops	0xF0	0x18	The number of loops is not recognised
Loop 2 Auto Hold Type Invalid	0xF0	0x19	The auto hold type is not recognized

Read a Profile Header Request & Response Sequence

Read A Profile Header - Request (to instrument)			
Field Name	Data		Comments
	Dec	Hex	
Unit Address	A/R	A/R	The ID address of the instrument
Function Code	23	17	Requires the multi read/write function
Read Start Address High Byte	32	20	
Read Start Address Low Byte	6	6	

Read Quantity Of Registers High Byte	0	0	
Read Quantity Of Registers Low Byte	19	13	
Write Start Address High Byte	32	20	
Write Start Address Low Byte	6	6	
Write Quantity Of Registers High Byte	0	0	
Write Quantity Of Registers Low Byte	2	2	
Byte Count	4	4	
Command Code High Byte	82	52	
Command Code Low Byte	80	50	
Profile Number High Byte	A/R	A/R	Profile number from 0 to 63
Profile Number Low Byte	A/R	A/R	
CRC High Byte	A/R	A/R	
CRC Low Byte	A/R	A/R	

The instrument replies to the Read A Profile Header request as follows:

Read Profile Header - Response (from instrument)			
Field Name	Data		Comments
	Dec	Hex	
Unit Address	A/R	A/R	The ID address of the instrument
Function Code	23	17	The multi read/write function
Byte Count	38	26	
Profile Name Character 1	A/R	A/R	The ASCII codes equivalent to each of the 16 characters of the profile name, e.g.: A = 65dec / 0x41, B = 66dec / 0x42 etc. a = 97dec / 0x61, b = 98dec / 0x62 etc.
Profile Name Character 2	A/R	A/R	
Profile Name Character 3	A/R	A/R	
Profile Name Character 4	A/R	A/R	
Profile Name Character 5	A/R	A/R	
Profile Name Character 6	A/R	A/R	
Profile Name Character 7	A/R	A/R	
Profile Name Character 8	A/R	A/R	
Profile Name Character 9	A/R	A/R	
Profile Name Character 10	A/R	A/R	
Profile Name Character 11	A/R	A/R	
Profile Name Character 12	A/R	A/R	
Profile Name Character 13	A/R	A/R	
Profile Name Character 14	A/R	A/R	
Profile Name Character 15	A/R	A/R	
Profile Name Character 16	A/R	A/R	
Profile Start Signal High Byte	0	0	0 = No delay, 1 = After delay, 2 = At Time/day
Profile Start Signal Low Byte	A/R	A/R	

Profile Start Time (Byte 4 - High)	A/R (Floating point number)	The time, in elapsed seconds, from the start trigger before a profile will begin if Start Signal =1 (After Delay) or seconds from midnight if Start Signal =2 (Time of Day) Is zero if Start Signal =0 (No Delay)	
Profile Start Time (Byte 3)			
Profile Start Time (Byte 2)			
Profile Start Time (Byte 1 - Low)			
Profile Start Day High Byte	0	0	1 = Monday, 2 = Tuesday, 3 = Wednesday, 4 = Thursday, 5 = Friday, 6 = Saturday, 7 = Sunday, 8 = Monday to Friday, 9 = Monday to Saturday, 10 = Saturday And Sunday, 11= All Week
Profile Start Day Low Byte	A/R	A/R	
Profile Starting Setpoint High	0	0	0 = Current Setpoint, 1 = Current Process Value
Profile Starting Setpoint Low	A/R	A/R	
Profile Recovery High Byte	0	0	0 = Control to off, 1 = Restart profile, 2 = Maintain last profile setpoint, 3 = Use controller setpoint, 4 = Continue profile from where it was when power failed
Profile Recovery Low Byte	A/R	A/R	
Profile Recovery Time (Byte 4 - high)	A/R (Floating point number)	The Profile Recovery Time (before the recovery action will be used after power/signal returns) in elapsed seconds. <i>Is zero if no recorder (RTC) fitted - function not possible</i>	
Profile Recovery Time (Byte 3)			
Profile Recovery Time (Byte 2)			
Profile Recovery Time (Byte 1 - Low)			
Profile Abort action High Byte	0	0	0 = Control to off, 1 = Maintain last profile setpoint, 2 = Use controller setpoint
Profile Abort Action Low Byte	A/R	A/R	
Profile Cycles High Byte	A/R	A/R	1 to 9999 or 10,000 for "Infinite"
Profile Cycles Low Byte	A/R	A/R	
Profile Number of Loops High Byte	0	0	The number of loops controlled by the profile: 1 or 2
Profile Number of Loops Low Byte	A/R	A/R	
CRC High Byte	A/R	A/R	
CRC Low Byte	A/R	A/R	

Read a Segment

Read A Segment - Request (to instrument)			
Field Name	Data		Comments
	Dec	Hex	
Unit Address	A/R	A/R	The ID address of the instrument
Function Code	23	17	Requires the multi read/write function
Read Start Address High Byte	32	20	
Read Start Address Low Byte	6	6	
Read Quantity Of Registers High Byte	0	0	
Read Quantity Of Registers Low Byte	17	11	
Write Start Address High Byte	22	16	
Write Start Address Low Byte	6	6	
Write Quantity Of Registers High Byte	0	0	
Write Quantity Of Registers Low Byte	3	3	
Byte Count	6	6	
Command Code High Byte	82	52	
Command Code Low Byte	83	53	

Profile Number High Byte	A/R	A/R	
Profile Number Low Byte	A/R	A/R	
Segment Number High Byte	A/R	A/R	
Segment Number Low Byte	A/R	A/R	
CRC High Byte	A/R	A/R	
CRC Low Byte	A/R	A/R	

The instrument replies to the Read A Segment request as follows:

Read A Segment - Response (from instrument)			
Field Name	Data		Comments
	Dec	Hex	
Unit Address	A/R	A/R	The ID address of the instrument
Function Code	23	17	The multi read/write function
Byte Count	34	22	
Command Response High Byte	82	52	
Command Response Low Byte	83	53	
Profile Number High Byte	A/R	A/R	
Profile Number Low Byte	A/R	A/R	
Segment Number High Byte	A/R	A/R	
Segment Number Low Byte	A/R	A/R	
Segment Type High Byte	0	0	0 = Ramp Time, 1 = Ramp Rate, 2 = Step, 3 = Dwell, 4 = Hold, 5 = Loop, 6 = Join, 7 = End, 8 = Repeat sequence then end
Segment Type Low Byte	A/R	A/R	
Segment Info A (Byte 4 - High)	A/R (Floating point number)		The meaning of the data contained in Segment Info A depends on the type of segment it relates to. See below.
Segment Info A (Byte 3)			
Segment Info A (Byte 2)			
Segment Info A (Byte 1 - Low)			
Segment Info B (Byte 4 - High)	A/R (Floating point number)		The meaning of the data contained in Segment Info B depends on the type of segment it relates to. See below.
Segment Info B (Byte 3)			
Segment Info B (Byte 2)			
Segment Info B (Byte 1 - Low)			
Auto Hold Type Loop 1 High Byte	A/R	A/R	0 = Auto-Hold Off, 1 = Hold above SP, 2 = Hold below SP, 3 - Hold above and below SP
Auto Hold Type Loop 1 Low Byte	A/R	A/R	
Auto Hold Value Loop 1 (Byte 4 - High)	A/R (Floating point number)		The distance loop 2 can be way from setpoint before Auto-Hold activates.
Auto Hold Value Loop 1 (Byte 3)			
Auto Hold Value Loop 1 (Byte 2)			
Auto Hold Value Loop 1 (Byte 1 - Low)			
Events High Byte	0	0	The status of the five events are defined by the lowest 5 bits of the low byte. A bit value of 1 signifies the event is on. Bit 0 = event 1, bit 1 = event 2, bit 2 = event 3, bit 3 = event 4 and bit 4 = event 5.
Events Low Byte	A/R	A/R	
Segment Info B Loop 2 (Byte 4 - High)	A/R (Floating point number)		The meaning of the data contained in Segment Info B depends on the type of segment it relates to. See below.
Segment Info B Loop 2 (Byte 3)			
Segment Info B Loop 2 (Byte 2)			
Segment Info B Loop 2 (Byte 1 - Low)			

Auto Hold Type Loop 2 High Byte	A/R	A/R	0 = Auto-Hold Off, 1 = Hold above SP, 2 = Hold below SP, 3 - Hold above and below SP
Auto Hold Type Loop 2 Low Byte	A/R	A/R	
Auto Hold Value Loop 2 (Byte 4 - High)	A/R (Floating point number)		The distance loop 2 can be way from setpoint before Auto-Hold activates. (Always 0 when profile only controls a single loop)
Auto Hold Value Loop 2 (Byte 3)			
Auto Hold Value Loop 2 (Byte 2)			
Auto Hold Value Loop 2 (Byte 1 - Low)			
CRC High Byte	A/R	A/R	
CRC Low Byte	A/R	A/R	

Segment Data

The Segment Data is included in the response to a Read Segment request. It is provided in two parts (Segment Info A and B).

The meaning of the data contained in Segment Info A and B depends on the type of segment it relates to. *Null* is shown for unused data, this can be any value.

Segment Type	Segment Info		Description
	A	B	
Ramp Time	Time	Target setpoint	Ramp to the target setpoint "B" in the time "A"
Ramp Rate	Ramp rate	Target setpoint	Ramp to the target setpoint "B" at the ramp rate "A"
Step	<i>Null (0)</i>	Target setpoint	Step to a target setpoint "B"
Dwell	Dwell time	<i>Null (0)</i>	Stay at the current setpoint for time "A"
Hold	0 = Operator	<i>Null (0)</i>	Wait for the operator to release the hold or Digital Input
	1 = Time of day	Start Time	Wait until time of the day "B" in seconds since midnight (<i>recorder only</i>).
	Number of times to repeat 1 to 9999	Segment number	Loop to the specified segment number "B" from this point. Repeat this "A" times. Only segments below the current segment can be entered. Two loops must not cross each other.
Join	<i>Null (0)</i>	Profile number	On completion of this profile run profile "B"
End	0 = Control off	<i>Null (0)</i>	Turn off all control outputs.
	1 = Maintain profile setpoint	<i>Null (0)</i>	Stay at the final setpoint of the profile
	2 = Use controller setpoint	<i>Null (0)</i>	Use the active controller setpoint.
Repeat Sequence Then End	0 = Outputs off	Number of times to repeat sequence	Repeat the profile sequence number "B" times, then turn off the control outputs
	1 = Maintain profile setpoint		Repeat the profile sequence number "B" times, then hold the last profile setpoint.
	2 = Use controller setpoint		Repeat the profile sequence number "B" times, then use the active controller setpoint.

Read a Profile Name

This command requests the name of a specific profile. The instrument responds with the name of the profile number requested.

Read Profile Name - Request (to instrument)			
Field Name	Data		Comments
	Dec	Hex	
Unit Address	A/R	A/R	The ID address of the instrument
Function Code	23	17	Requires the multi read/write function
Read Start Address High Byte	32	20	
Read Start Address Low Byte	6	6	
Read Quantity Of Registers High Byte	0	0	
Read Quantity Of Registers Low Byte	8	8	
Write Start Address High Byte	32	20	
Write Start Address Low Byte	6	6	
Write Quantity Of Registers High Byte	0	0	
Write Quantity Of Registers Low Byte	2	2	
Byte Count	4	4	
Command Code High Byte	80	50	
Command Code Low Byte	78	4E	
Profile Number High Byte	A/R	A/R	
Profile Number Low Byte	A/R	A/R	
CRC High Byte	A/R	A/R	
CRC Low Byte	A/R	A/R	

The instrument replies to the Read Profile Name request as follows:

Read Profile Name - Response (from instrument)			
Field Name	Data		Comments
	Dec	Hex	
Unit Address	A/R	A/R	The ID address of the instrument
Function Code	23	17	The multi read/write function
Byte Count	16	10	
Profile Name Character 1	A/R	A/R	The ASCII codes equivalent to each of the 16 characters of the profile name, e.g. : A = 65dec / 0x41, B = 66dec / 0x42 etc. a = 97dec / 0x61, b = 98dec / 0x62 The space character (32dec / 0x20hex) is used to fill any unused characters at the end of the name.
Profile Name Character 2	A/R	A/R	
Profile Name Character 3	A/R	A/R	
Profile Name Character 4	A/R	A/R	
Profile Name Character 5	A/R	A/R	
Profile Name Character 6	A/R	A/R	
Profile Name Character 7	A/R	A/R	
Profile Name Character 8	A/R	A/R	
Profile Name Character 9	A/R	A/R	
Profile Name Character 10	A/R	A/R	
Profile Name Character 11	A/R	A/R	

Profile Name Character 12	A/R	A/R	
Profile Name Character 13	A/R	A/R	
Profile Name Character 14	A/R	A/R	
Profile Name Character 15	A/R	A/R	
Profile Name Character 16	A/R	A/R	
CRC High Byte	A/R	A/R	
CRC Low Byte	A/R	A/R	

Read Profile Memory Status

This command returns the status of the profile memory used. The response to this command is to return a table of all the profile numbers that are in use. A value of 0x00 indicates that the profile position is free and value of 0x01 indicates that the position is used by a profile. Using this command in conjunction with the read profile name command can be used to create a directory of profile numbers and profile names.

Read Profile Memory Status - Request (to instrument)			
Field Name	Data		Comments
	Dec	Hex	
Unit Address	A/R	A/R	The ID address of the instrument
Function Code	23	17	Requires the multi read/write function
Read Start Address High Byte	32	20	
Read Start Address Low Byte	6	6	
Read Quantity Of Registers High Byte	0	0	
Read Quantity Of Registers Low Byte	32	20	
Write Start Address High Byte	32	20	
Write Start Address Low Byte	6	6	
Write Quantity Of Registers High Byte	0	0	
Write Quantity Of Registers Low Byte	1	1	
Byte Count	2	2	
Command Code High Byte	80	50	
Command Code Low Byte	83	53	
CRC High Byte	A/R	A/R	
CRC Low Byte	A/R	A/R	

The instrument replies to the Read Profile Memory Status request as follows:

Read Profile Status

Read Profile Memory Status - Response (from instrument)			
Field Name	Data		Comments
	Dec	Hex	
Unit Address	A/R	A/R	The ID address of the instrument
Function Code	23	17	The multi read/write function
Byte Count	64	40	
Profile 0 Position	0 or 1	0 or 1	

Profile 1 Position	0 or 1	0 or 1	For each of the 64 possible profile positions, a value of 0 is returned if the position is free, or 1 if the position is empty.
<i>etc.....</i>			
Profile 62 Position	0 or 1	0 or 1	
Profile 63 Position	0 or 1	0 or 1	
CRC High Byte	A/R	A/R	
CRC Low Byte	A/R	A/R	

21 Glossary

Active Setpoint

The term Active Setpoint is used to describe the currently selected setpoint when the instrument is in controller mode. Controllers can use the Main local setpoint and/or the Alternate Setpoint. Only one of the setpoints can be active at any time. During profiler control, the setpoint value is controlled by the profiler function.

Also refer to: Actual Setpoint; Alternate Setpoint; Controller Mode; Local Setpoints; Profiler Mode; Remote Setpoint; Setpoint; and Setpoint Selection.

Actual Setpoint

Actual Setpoint is the effective current value of the active setpoint. This will be different to the setpoints target value during setpoint ramps. The actual setpoint will rise or fall at the ramp-rate set, until it reaches its target setpoint value. During profile control, the actual setpoint value is controlled by the profiler function.

Also refer to: Active Setpoint; Controller Mode; Profiler Mode; Setpoint; Setpoint Ramp Rate and Setpoint Selection.

Alarm Activation Inhibit

Alarm Inhibit prevents unwanted alarm activation at power-up or when the controller setpoint is changed. The alarm activation is inhibited until a 'Safe' (non-alarm) condition is present. The alarm operates normally from that point onwards. E.g. if inhibited, a low alarm will not activate at power-up, until the process has first risen above the alarm point and then falls back below. This parameter is in addition to the alarm minimum duration setting.

Also refer to: Alarm Duration Inhibit; Alarm Types and Alarm Operation.

Alarm Configuration

A sub-menu of the configuration menu, used to adjust the alarm parameters (alarm types, values, hysteresis, minimum duration and inhibiting).

Also refer to: Alarm Hysteresis; Alarm Inhibit; Alarm Operation; Alarm Types and Configuration Mode.

Alarm Duration Inhibit

An adjustable alarm configuration time. After an alarm trigger point is passed, the alarm is inhibited from activation until this time has elapsed. If the alarm trigger is removed before the time has passed (e.g. the process falls back below a high alarm value) the alarm will not activate at all. The time duration inhibit is not applied when an alarm condition ends. This parameter is in addition to the alarm activation inhibit.

Also refer to: Alarm Hysteresis; Alarm Inhibit; Alarm Operation; Alarm Types and Configuration Mode.

Alarm Hysteresis

An adjustable band through which the process variable must pass before the alarm will change state. The band is always on the "safe" side of an alarm point, e.g. a high alarm's hysteresis band is below the high alarm value, and a low alarm's hysteresis is above the low alarm value.

Refer to the *Alarm Hysteresis Operation* diagram on the next page.

Also refer to: Alarm Duration Inhibit; Alarm Types; Loop Alarm; Alarm Operation; LSD; Process Variable; and Rate Of Change Alarm.

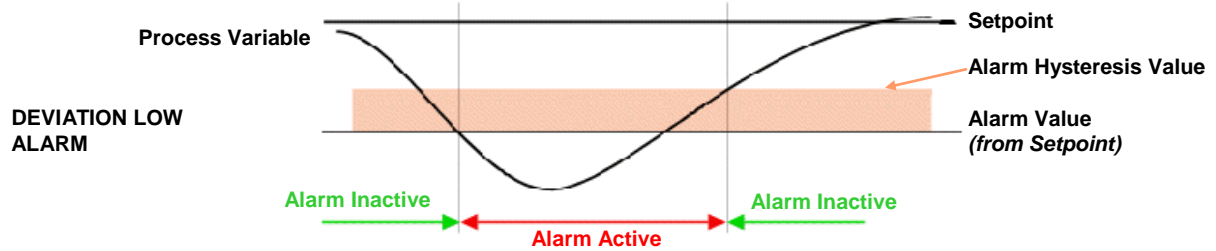
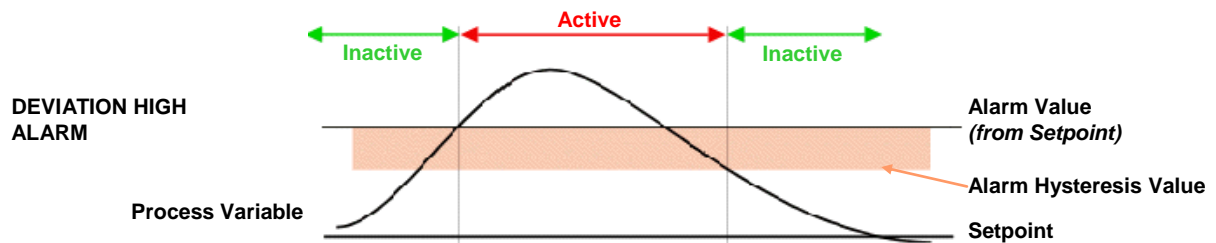
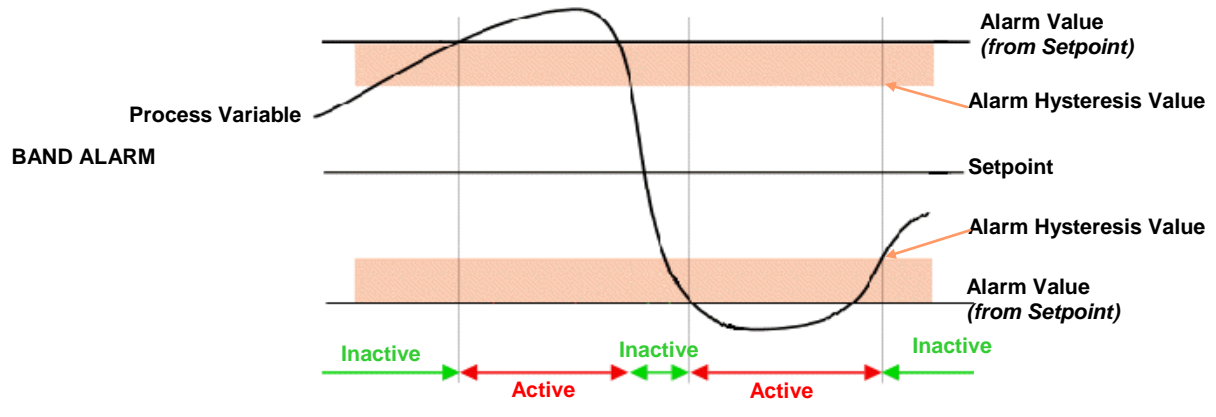
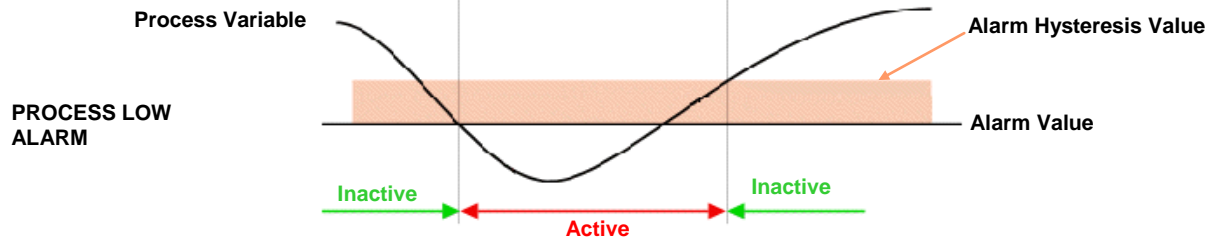
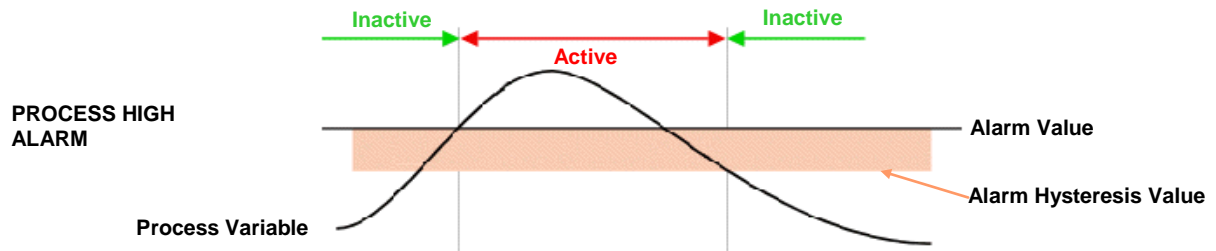

Alarm Operation

The process and control deviation alarm types are illustrated, together with the action of any associated outputs.

Also refer to: Alarm Hysteresis; Alarm Inhibit; Alarm Types; Band Alarm Value; Deviation Alarm; Latching Relay; Logical Alarm Combinations; Loop Alarm; Process High Alarm and Process Low Alarm.

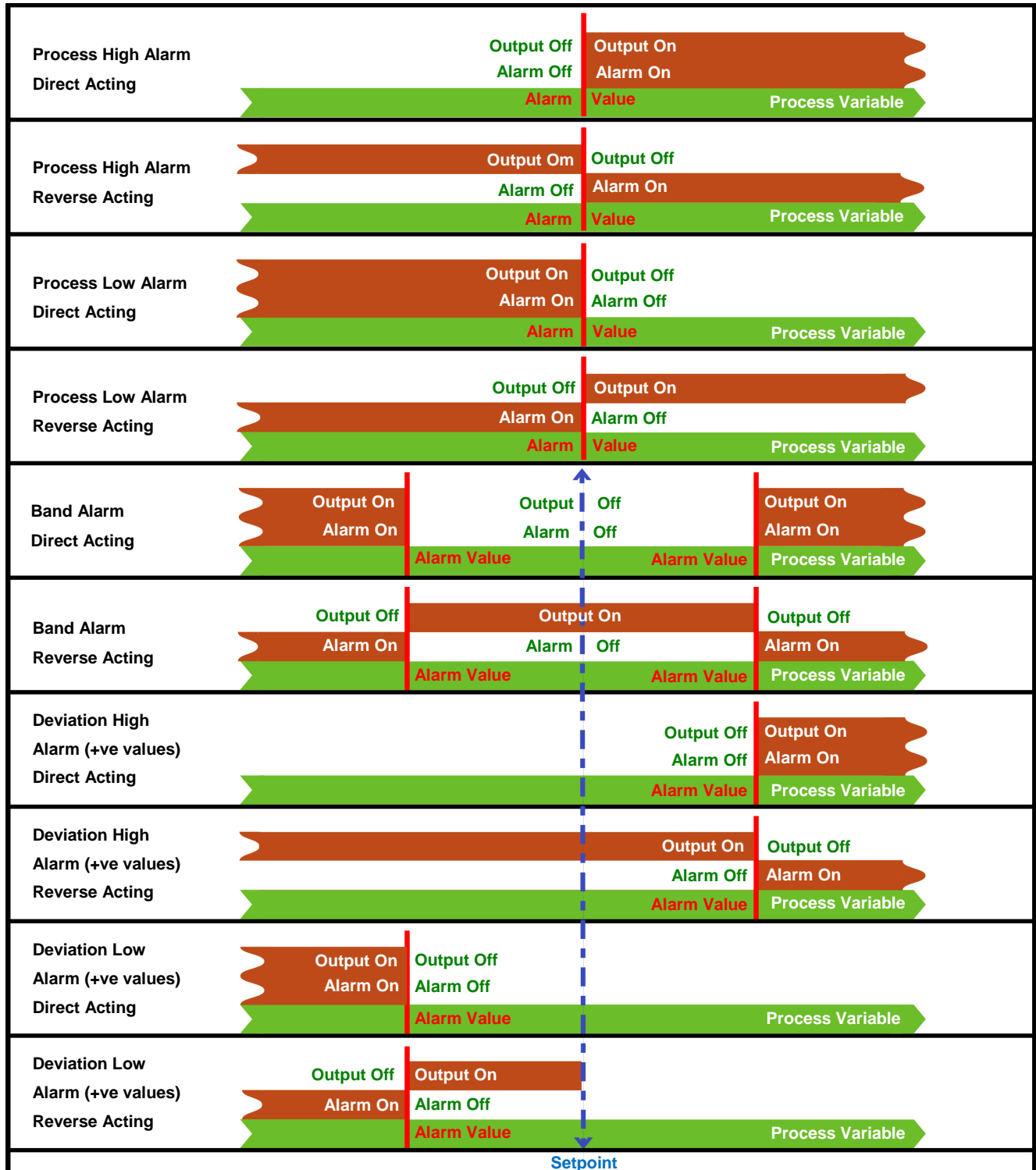

Figure 64. Alarm Operation

Alarm Types

There are three basic alarm types, Process Alarms, Control Deviation Alarms and Event Based Alarms; plus some special condition alarms.

Process Alarms are based on the absolute value of the Process Variable. If the PV rises above a high alarm value, or falls below a low alarm value, the alarm will become active.

Control Deviation Alarms are based on the value of the Control Deviation error. If the PV is more than the high deviation alarm value above setpoint, or more than the low deviation alarm value below setpoint, the alarm will become active.

Event based alarms activate when the condition for that alarm type is true. These can be Signal Break, Low Memory or Loop Alarms.

Rate of Signal Change Alarm is based on the rate of change of the PV. If the rate of change is greater than the alarm value for longer than the Minimum Duration time, the alarm will activate. Control Power High and Control Power Low alarms are based on the output power from the PID control algorithm.

Also refer to: Alarm Operation; Band Alarm Value; Control Deviation; Control Power Alarm; Deviation Alarm; Loop Alarm; PID; Process High Alarm; Process Low Alarm; Process Variable; Rate Of Change Alarm; and Setpoint.

Alternate Setpoint

The instrument can use one of two setpoints (Main or Alternate). The alternate setpoint can be chosen from Local Setpoint 2 or a remote setpoint input from Auxiliary Input A if fitted. One setpoint can be chosen as the active at using the setpoint selection screen.

Also refer to: Auxiliary Input; Local Setpoints; Main Setpoint; Profiler; Remote Setpoints; Setpoint and Setpoint Select.

Auto Pre-Tune

When the auto pre-tune is enabled, a pre-tune activation is attempted at every power-up (*Standard Pre-Tune activation rules apply*). Auto pre-tune is useful when the process to be controlled may vary significantly each time it is run. Auto pre-tune ensures that the process is tuned correctly each time the process is started. Self-tune may also be engaged to fine-tune the controller.

Also refer to: Pre-Tune; Self-Tune; PID and Tuning.

Automatic Reset

- Refer to *Integral Action*

Auxiliary Input

A secondary linear input module can be installed in option slot A to provide a remote setpoint input. Signals can be mA, or VDC. The 2nd Universal input can also be used as an auxiliary input if fitted.

Also refer to: Alternate Setpoint; Digital Input; Linear Input; mADC; Remote Setpoint and VDC

Auxiliary Input Lower Limit

When auxiliary input A is used to provide a remote setpoint (RSP), this setting defines the Alternate Setpoint value when the auxiliary input signal is at its minimum value (e.g. for 4 to 20mA, the value when 4mA is applied). However, the setpoint is always constrained by the setpoint limits.

Also refer to: Alternate Setpoint; Auxiliary Input; Auxiliary Input Upper Limit; Auxiliary Input Offset; Remote Setpoint; Setpoint and Setpoint Upper Limit and Setpoint Lower Limit.

Auxiliary Input Offset

Used to adjust the value of auxiliary input A if it provides a Remote Setpoint. Positive values are added to the remote setpoint value, negative values are subtracted, but the setpoint is still constrained by the setpoint limits.

Also refer to: Auxiliary Input; Remote Setpoint; Scaled Input Upper Limit; Scaled Input Lower Limit Setpoint Lower Limit and Setpoint Upper Limit.

Auxiliary Input Type

Defines the type and range of the linear input signal for auxiliary input A. It can be mADC or VDC. This can be used as a Remote Setpoint input.

Also refer to: Remote Setpoint and Setpoint.

Auxiliary Input Upper Limit

When the auxiliary input is used to provide a Remote Setpoint (RSP), this setting defines the value of the RSP when the auxiliary input signal is at its maximum value (e.g. for 4 to 20mA, the value when 20mA is applied). However, the RSP value is always constrained by the setpoint limits.

Also refer to: Auxiliary Input; Auxiliary Input Lower Limit; Auxiliary Input Offset; Remote Setpoint; Setpoint and Setpoint Upper Limit and Setpoint Lower Limit.

Band Alarm Value

The amount of control deviation that is acceptable before a Band Alarm is activated. If the process variable is more than the value of this band from the actual setpoint, the alarm will be active.

Also refer to: Actual Setpoint; Alarm Operation; Alarm Types; Control Deviation; Input Span; LSD and Process Variable.

Bar Graphs

The instrument displays uni or bi-directional bar-graphs in the operation mode for loop 1 & 2 PID power (single control = 0 to 100%, dual control = -100% to +100%), control deviation (-5% to +5%) and % Recorder Memory Used (0 to 100%). In Profiler Mode, profile & current segment bar-graphs are shown (0 to 100%).

Also refer to: Control Deviation; Data Recorder; Display Configuration; Operation Mode; Main Menu; PID and Profiler.

Bias

- Refer to *Manual Reset*.

Bumpless Transfer

A method used to prevent sudden changes to the correcting variable, when switching between automatic PI or PID and Manual control modes. During a transition from PI or PID to manual control, the initial manual power value is set to the previous automatic mode value. The operator then adjusts the value as required. During a transition from manual control to PI or PID, the initial automatic value is set to the previous manual mode value. The correcting variable level will gradually adjusted by the control algorithm at a rate dependant on the integral action resulting from the integral time constant value. A similar Bumpless transfer is used with Gain Scheduling when switching PID Sets. Since integral action is essential to Bumpless Transfer, this feature is not available if integral is turned off.

Also refer to: Correcting Variable; Gain Scheduling; Integral Action; Manual Mode; PI and PID.

Calibration

Adjustment or correction of the displayed values relative to the actual measured values.

Refer to the User Calibration section of this manual for calibration use and instructions.

Also refer to: Multi-point Scaling and Process Variable.

Cascade Control

Applications with long time lags (e.g. indirect heat via hot water jackets) can be difficult to control with a single control loop. The solution is to split the process into two (or more) cascaded loops consisting of a Master and Slave acting on a common actuator. The 2-loop version with built-in cascade feature is ideal for this type of application, although it can be achieved with two discrete controllers, one with a setpoint retransmission output and the other with a remote setpoint input.

The master controller measures the main process variable and compares it to the desired product setpoint. Its PID output becomes the slave's effective setpoint (scaled to suit the process). This is compared the slave's process input, and the controlling actuator is adjusted accordingly.

Refer to the Cascade Control section of this manual for full details.

Also refer to: Master & Slave; Proportional Control; PID; Remote Setpoint and Setpoint.

Clock Configuration

A sub-menu of the configuration menu used to adjust the setting of the real time clock fitted with the data recorder option (e.g. date, time, and date format).

Also refer to: Data Recorder and Configuration Mode

Communications Write Enable

Enables/disables the changing of parameter values via the Serial Communications link, if a communication option such as Modbus RTU (RS485) or Modbus TCP (Ethernet) is installed. When disabled, communication becomes read-only.

Also refer to: Ethernet; Modbus RTU; Modbus TCP; RS485 and Serial Communications

Configuration Menu

A selection of sub-menus from which the user can adjust the major instrument settings. There are sub-menus for the Inputs, Control, Outputs, Alarms, Communications, Recorder, Clock, Display and Lock Codes. Configuration mode is entered from the main menu. An unlock code is required to access this mode.

Refer to the Configuration Menu information in the Configuration & Use section.

Also refer to: Alarm Configuration, Lock Codes, Clock Configuration, Control Configuration, Display Configuration, Input Configuration, Main Menu, Output Configuration, Recorder Configuration, Serial Communications Configuration

Contactors

- Refer to *Relay*

Continuous Control

Current or voltage correcting variables using linear outputs (4 to 20mA, 0-20mA, 0 to 5V, 0 to 10V or 2 - 10V DC) for proportional control, PI, PD or PID control modes. On-Off control cannot be used with linear outputs.

Also refer to: Correcting Variable; Linear Output; On-Off Control; PD; PI; PID; Proportional Control; and Time Proportional Control.

Control Configuration

A sub-menu of the configuration menu used to adjust the parameters that relate to the control of the process (enabling control, auto/manual mode, control type and action, PID tuning terms, power limits, sensor break action, setpoint values and setpoint selection).

Also refer to: Configuration Mode; Control Action; Control Enable; Local Setpoints; Manual Mode; PID; Setpoint Selection and Tuning.

Control Deviation

Control Deviation is the difference between the process variable value and the actual setpoint. The control deviation error is equal to $PV - SP$. This value can be monitored using the bar-graph ($\pm 5\%$ of span). An excessive deviation warning can be given by using a deviation or band alarm.

Also refer to: Actual Setpoint; Alarm Types; Band Alarm; Bar Graph; Deviation Alarm; Input Span; Process Variable and Setpoint

Control Action

This refers to the control loop(s) primary power output direction. Reverse action is typically used with heating applications as it increases the correcting variable as the process variable falls. If a secondary output has been configured, its action is always the opposite of the primary output.

Also refer to: Control Type; Correcting Variable; Direct Acting Control and Reverse Acting Control.

Control Enable/Disable

The PID controller outputs can be temporarily turned off by disabling the control. When control is disabled the setpoint value is replaced by "OFF". All other functions continue as normal. The control enable/disable function can be controlled from the control configuration sub-menu, via a digital input or optionally from the operation menu if enabled in the display configuration sub-menu.

Also refer to: Digital Input; Display Configuration; Operation Mode and PID

Control Power Alarm

A control power alarm is based on the output from the PID control algorithm. It can provide a warning if the PID output rises above or falls below a set value. This is often used in conjunction with the minimum alarm duration time so that very brief power output peaks can be ignored.

Also refer to: Alarm Duration Minimum; Alarm Types and PID

Control Type

This defines if a control loop has Single (unidirectional) or Dual (bidirectional) control outputs. Single outputs have a primary output only. This can drive the process in one direction (e.g. heat only, cool only, increase humidity etc). Dual outputs have both primary and secondary outputs which can force the process to increase or decrease (e.g. heat & cool, humidify & dehumidify etc).

Also refer to: Control Action; PID; Primary Proportional Band; Process Variable; and Secondary Proportional Band.

Controller

An instrument that controls one or more process control loops. For each control loop it compares a process variable to a target setpoint, and attempts to make the process maintain the setpoint value by applying a correcting variable (e.g. turning on a heater or dosing with alkali if controlling pH). The controller uses proportional (P, PI, PD or PID) or On-Off control.

Also refer to: Correcting Variable; Indicator; Limit Controller; On-Off Control; PD Control; PI Control; PID; Process Variable; Proportional Control; Profiler and Setpoint.

Controller Mode

The normal operating mode when profiling is not fitted or it is not being used.

Also refer to: Controller; Profiler and Profiler Mode

Correcting Variable

The output level from a controller used to adjust the process variable up or down, in order to remove any control deviation. This might be turning on a chiller in a temperature application or increasing the variable speed drive of a pump in a flow application. The level of correcting variable is commonly referred to as the controller output power.

Also refer to: Control Deviation; PID; Primary Power Output Limit and Process Variable

CPU

This stands for Central Processing Unit and refers to the on-board microprocessor that controls the measurement, control, alarm; display and other functions of the instrument.

Custom Display Mode

The user can copy up to 50 Configuration Menu parameters into operation mode using the PC software. If enabled in the display configuration sub-menu, the configured parameters follow the normal operation mode screens. In this mode these screens are not protected by a lock code.

Also refer to: Control Configuration; Display Configuration; Lock Codes and Operation Mode

Cycle Time

For time proportioning outputs, the cycle time is the period over which the controller averages the ON vs. OFF time, in order to provide the required correcting variable. Each control loop has separate cycle times for the primary and secondary control outputs. Shorter cycle times give better control, but at the expense of reduce life for any electromechanical control devices (e.g. relays or solenoid valves). Short cycle times do not harm SSRs.

Also refer to: Correcting Variable; PID; Primary Proportional Band; Proportional Control; Relay; Secondary Proportional Band; Solenoid Valve; SSR and Time Proportioning.

Data Recorder

The Data Recorder option can record the process values, setpoints, alarms and events over time. Recordings can be transferred to a USB memory stick or via the serial communications options for analysis in the PC software or spreadsheets. This option includes a battery backed-up real time clock (RTC) which continues to keep time when the instrument is powered down.

Refer to the Data Recorder Option section of this manual for full details.

Also refer to: PC Software and Recorder Configuration.

Deadband

- Refer to *Overlap/Deadband*.

Derivative Action

Derivative action biases the proportional control output to compensate for the rate of change in the process variable. In a typical reverse acting application, derivative power is increased if the PV is rising, or decreased if it is falling. The combined proportional and derivative values adjust the correcting variable until the process stabilises, at which point derivative power becomes zero. Increasing the derivative time increases the effect of derivative action.

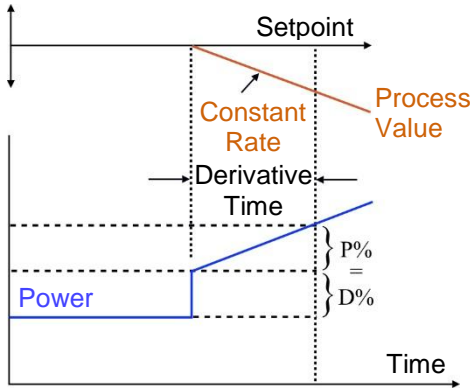

The Derivative Time Constant is defined as the time interval in which the part of the output signal due to proportional action increases by the same amount as the immediate output change due to derivative action, when the control deviation error is changing at a constant rate. As the PV falls at a fixed rate, derivative action causes a step in power output (D%), and over time proportional power (P%) increases as the PV falls within the proportional band. *For the purpose of the definition, the increased power does not affect the PV (in reality it would begin correcting the control error). Derivative must be set*

to OFF if PI control is required, and it is not available if the primary output is set to on-off.

Also refer to: Modulating Valve; On-Off Control; PD Control; PI Control; PID; PID Sets; Process Variable and Tuning.

Deviation Alarm

An alarm configured to activate once an unacceptable amount of control deviation error occurs. A positive value (deviation high) sets the alarm point above the current actual setpoint, a negative value (deviation low) sets the alarm point below actual setpoint. If the process variable deviates from the actual setpoint by a margin greater than this value, the alarm becomes active. If an alarm is required if the control deviation is either side of the setpoint, consider using a Band alarm or a logical combination of a deviation high and deviation low alarm.

Also refer to: Actual Setpoint; Alarm Operation; Alarm Types; Band Alarm; Control Deviation; Logical Combination; Process Variable and Setpoint.

Digital Input

An input that can be driven to one of two states (active or inactive) by and external voltage or a contact opening/closing. Digital Inputs can be used to set the instrument in to different states. Typical uses are to select auto/manual mode, active setpoint selection, control enable/disable, profile selection, profile run/hold/abort, hold segment release, recorder trigger, tuning start/stop and latching alarm reset. Digital inputs may be "inverted" so that they are inactive when on.

Also refer to: Active Setpoint; Control Enable; Data Recording; Invert Digital Inputs; Manual Mode; Profiling and Segment Types.

Direct Acting Control

Direct action is required for applications where the primary control output will be used to force the process variable down towards the setpoint. A typical application is a chiller. When the control action is selected as direct acting, primary proportional control outputs decrease the correcting variable as the process variable reduces within the proportional band, and primary On-Off outputs turn off when the process variable is less than the setpoint. The control action of a secondary output is always the opposite of the primary output.

Also refer to: Control Action; Control Type; Correcting Variable; On-Off Control; Process Variable; Proportional Control and Reverse Acting Control.

Display Configuration

A sub-menu of configuration mode used to adjust the display (colour & contrast) and to enable access to selected parameters from operation mode. These are: Profile Control; Recorder Start/Stop; Recorder Status; Loop 1 & 2 Setpoint Select; Loop 1 & 2 Auto/Manual Select; Loop 1 & 2 Control Enable/Disable; Loop 1 & 2 Trend View; Loop 1 & 2 Setpoint Ramp Rate. It also has settings for language selection, to enable the custom menus or to make operation mode read-only.

Also refer to: Configuration Mode; Control Enable; Custom Display Mode; Display Language; Manual Control; Operation Mode; Profile Control; Setpoint Ramp Rate; Recorder; Setpoint Select and Trend Display.

Display Languages

The instrument supports two languages. The main language is English. The alternate language is chosen at time of order, but can also be changed by downloading a new file via the PC software. Supported languages include English, French, German, Italian and Spanish.

Also refer to: Display Configuration; Operation Mode; Main Menu and PC Software.

Display Resolution

The maximum number of digits that can be displayed and/or the maximum number of decimal places. Numeric values (e.g. process variable, setpoints etc) are limited to no more than 5 digits.

The maximum number of decimal places is selectable from 0 to 3 places, but the overall 5-digit limit means that larger values reduce the number of decimal places shown. For example, values >99.999 will show no more than 2 decimal places (e.g. 100.00).

Also refer to: LSD.

Effective Setpoint

- Refer to *Actual Setpoint*.

Engineering Units

The Process Variable and Setpoint displays can assigned engineering units to describe the signals connected to the process inputs. The engineering units for linear inputs can be: °C; °F; K; bar; %; %RH; pH; psi or none. For temperature inputs (RTD or Thermocouples) they can be °C; °F or K.

Also refer to: Linear Input; Process Input; Process Variable RTD and Thermocouple.

Ethernet

A networking technology for local area networks (LANs). Used to link computers and other equipment in order to share data or control such devices. If fitted with an Ethernet communications module in option slot A, this instrument can connect as a slave to a Modbus TCP master device via a wired Ethernet LAN connection.

Also refer to: Modbus TCP and Serial Communications.

Gain Scheduling

Gain scheduling bumplessly switches between pre-set PID values automatically at successively higher setpoint or process values. This allows optimal control across a wide range of process conditions, or if the controller is used in several different applications. It is especially useful if the process conditions change significantly during use, such as a process that becomes exothermic as the temperature rises.

Also refer to: Bumpless Transfer; PID; PID Sets; Process Variable and Setpoint.

Indicator

An instrument that displays process values, but lacks control features. Typically, alarm outputs are available that will activate at pre-set PV values.

Also refer to: Controller; Limit Controller and Process Variable.

Input Configuration

A sub-menu of configuration mode, used to adjust the parameters that relate to the process and auxiliary inputs (type, engineering units, decimal places, scaling, filtering etc.).

Also refer to: Auxiliary Input; Configuration Mode and Process Input.

Input Filter Time Constant

This parameter is used to filter out extraneous impulses affecting process variable values. The filtered PV is used for all PV dependent functions (display, control, alarm etc). Use this parameter with care as it will also slow the response to genuine process changes.

Also refer to: Process Variable.

Input Range

This is the overall process variable input range and type as selected by the Process Input Type parameter. This range can be scaled using the Scale Input Upper & Lower Limits.

Also refer to: Input Span; Process Input; Scaled Input Lower Limit and Scaled Input Upper Limit.

Input Span

The measuring and display limits, as defined by the Scale Input Lower and Scaled Input Upper Limits. The trimmed span value is also used as the basis for calculations that relate to the span of the instrument (e.g. proportional bands).

Also refer to: Input Range; LSD; Primary Proportional Band; Scaled Input Lower Limit; Scaled Input Upper Limit and Secondary Proportional Band.

Integral Action

Integral action biases the proportional control output to compensate for process load variations. Their combined values adjust the correcting variable, until the control deviation error is zero, at which point the integral value is held constant. Decreasing the integral time constant increases the integral action. Integral action is also known as “Automatic Reset”.

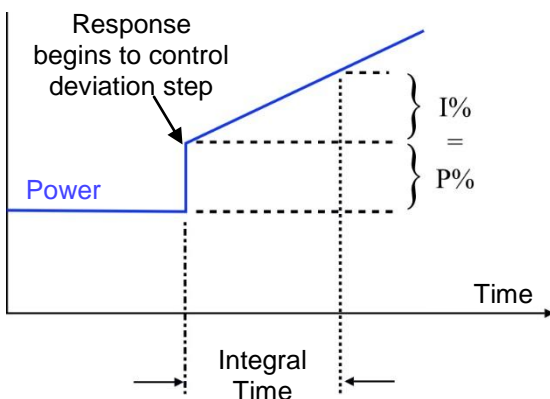

The time constant is defined as the interval in which the part of the output due to integral action increases by an amount equal to the part of the output due to the proportional action, when the control deviation is unchanging. For example, if a step change is made in the PV, the output immediately changes due to proportional action. The deviation error is integrated over time, steadily changing the integral output. The time it takes for integral power to change by the same amount due to proportional action (I% = P%) is the “reset”, or integral time. *For the purpose of*

the definition, the power output change does not affect the PV (in reality it would begin correcting the control error). Integral must be set to OFF if PD control is required, and it is not available if the primary output is set to On-Off.

Also refer to: Control Deviation; On-Off Control; PD Control; PI Control; PID; PID Sets; Primary Proportional Band; Secondary Proportional Band; Derivative Action; and Tuning.

Invert Digital Input

Digital inputs may be “inverted” so that they are active when off and inactive when on. This is useful if the signal applied to the chosen digital input function is reversed in relation the digital input action.

Also refer to: Digital Input.

Latching Output

Alarm outputs can be set to latch on when they become active. If enabled, an output will remain latched ON even if the condition that caused it to be on is no-longer present and it remains latched even if the unit is powered off-on. The output latch must be reset to turn it off. The latch reset signal can be via a digital input or using the front keys in the clear latched output screen. The alarm condition that caused the output to switch must have cleared before the latch can be deactivated.

Also refer to: Alarm Types; Digital Input and Relay

LED

Light Emitting Diode. Four LED's are used as indicator lights (e.g. for the alarm indication, automatic tuning stats, manual mode etc). Their function and labels can be changed with the PC software.

Also refer to: Alarm Operation; Alarm Types; Automatic Tuning; Manual Mode and PC Software.

Linear Input

A mVDC, mADC or voltage signal usually used to represent the value of the process variable for one of the PID control loops. This can be any variable that can be converted into a suitable DC linear signal. Common examples are Humidity, pressure, pH or temperature. One or optionally two main inputs are available, and an auxiliary linear input can also be installed to provide a remote setpoint source.

Also refer to: Auxiliary Input; Input Range; Linear Output; mVDC; mADC; PID; Process Variable; Remote Setpoint and VDC.

Linear Output

A mVDC, mADC or voltage signal used to provide a continuous proportional control output or to retransmit the process or setpoint values to an external device.

Also refer to: Continuous Control; Linear Input mVDC; mADC; Process Variable; Proportional Control; Retransmit Output; Setpoint and VDC

Limit Controller

A process protection device that can shut down a process at a pre-set “exceed condition”. Limit controllers work independently of the normal process controller in order to prevent possible damage to equipment or products. A fail-safe latching relay is fitted, which cannot be reset by the operator until the process has returned to a safe condition. Limit controllers are especially recommended for any process that could potentially become hazardous under fault conditions. Ensure you choose a limit controller with the correct approvals for local regulations (e.g EN 14597 etc) if it is to be used as a safety limiter.

Also refer to: Controller and Latching Relay.

Local Setpoints

Local setpoints are target setpoint values for the control loops that are entered by the user and stored in the controller. The value of local setpoints can be adjusted within the setpoint limits using the front keypad, or via a serial communications link.

The instrument can has two setpoints for each control loop. The main local setpoint and an alternate setpoint. The alternate setpoint can be a local setpoint or a remote setpoint from an auxiliary input. One setpoint at a time is chosen to be active using the setpoint selection.

Also refer to: Alternate Setpoint; Auxiliary Input; PID; Remote Setpoint; Serial Communications; Setpoint; Setpoint Lower Limit; Setpoint Upper Limit; and Setpoint Select.

Lock Codes

The four-digit passwords required when entering the setup wizard, configuration mode, tuning menu, supervisor mode, USB menu, recorder menu and profiler setup menu. The correct code must be entered to gain access. If unrestricted access is required for a menu, its lock can set to OFF.

Refer to the Lock Code Configuration sub-menu in the Configuration Menu.

Also refer to: Configuration Mode; Main Menu; Profiler Setup Menu; Recorder Menu; Setup Wizard; Supervisor Mode; Tuning Menu and USB Menu.

Logical Output Combinations

Any suitable output may be assigned as a logical OR or logical AND output of the alarm and profile event conditions, and can be configured for reverse or direct action. If OR is chosen, any of the selected alarms or profile events that are active will cause the output to turn on for direct acting outputs, or inactive for reverse acting outputs (NOR). If AND is chosen, all of the selected alarms or profile events must be active to cause the output to turn on for direct acting outputs, or inactive for reverse acting outputs.

The following table explains the concept of logical OR & AND outputs.

Also refer to: Alarm Operation; Alarm Types; Output Configuration and Profile Events.

EXAMPLES OF LOGICAL OUTPUTS

Logical OR: Alarm 1 OR Alarm 2										
Direct Acting					Reverse-Acting					
ALARM 1	OFF	ALARM 2	OFF	OUTPUT	OFF	ALARM 1	OFF	ALARM 2	OUTPUT	ON
	ON		OFF		ON		OFF			OFF
	OFF		ON		OFF		ON			ON
	ON		ON		ON		ON			OFF

Logical AND: Event 3 AND Alarm 2										
Direct Acting					Reverse-Acting					
Event 3	OFF	ALARM 2	OFF	OUTPUT	OFF	Event 3	OFF	ALARM 2	OUTPUT	ON
	ON		OFF		ON		OFF			ON
	OFF		ON		OFF		ON			ON
	ON		ON		ON		ON			OFF

Loop Alarm

A loop alarm detects faults in the control feedback in the selected loop, by continuously monitoring the process variable response to the control outputs. If any alarm is setup as a loop alarm, it repeatedly checks if the control output is at saturation. If saturation is reached (0% or 100% power for single control type, -100% or +100% for dual control type), an internal timer is started. Thereafter, if the output has not caused the process variable to be corrected by a predetermined amount 'V' after time 'T' has elapsed, the alarm becomes active. The alarm repeatedly checks the process variable and the control output. If the process starts to change in the correct direction or the control output is no longer at the limit, the alarm deactivates.

For PI or PID control, the loop alarm time 'T' can be automatic (twice the Integral Time value) or set to a user defined value up to 99m 59s. Correct operation with the automatic loop alarm time depends upon reasonably accurate PID tuning. The user defined value is always used for P, PD or On-Off control. The timer starts as soon as an output turns on with on-off control.

The value of 'V' is dependent upon the input type. For Temperature inputs, $V = 2^{\circ}\text{C}$ or 3°F . For Linear inputs, $V = 10 \times \text{LSD}$

The loop alarm is automatically disabled in manual control mode and during execution of a pre-tune. Upon exit from manual mode or after completion of the pre-tune routine, the loop alarm is automatically re-enabled.

Also refer to: Alarm Types; Control Type; Manual Loop Alarm Time; Linear Input; LSD; Manual Mode; On-Off Control; PD; PI; PID; Pre-Tune; Process Variable and Tuning.

LSD

The Least Significant Digit (LSD) is the smallest incremental value that can be shown at the defined display resolution.

Also refer to: Display Resolution.

mADC

This stands for milliamp DC. It is used in reference to the linear DC milliamp input ranges and the linear DC milliamp outputs. Typically, these will be 0 to 20mA or 4 to 20mA.

Also refer to: Input Range; Linear Input; Linear Output; mVDC; Process Variable and VDC

Main Menu

The top-level menu that allows access to operation mode as well as all other menus. These are: configuration mode, profiler setup and recorder menus, the setup wizard, supervisor mode and the tuning and USB menus. Most menus require an unlock code to gain access.

Refer to the Main Menu information in the Configuration & Use section.

Also refer to: Configuration Mode; Lock Codes; Operation Mode; Profiler Setup Menu; Recorder Menu; Setup Wizard; Supervisor Mode; Tuning Menu and USB Menu.

Main Setpoint

The instrument can has two setpoints for each control loop. The main local setpoint and an alternate setpoint. If used, the main setpoint is always a "local" setpoint. One setpoint can be chosen to be active from the setpoint selection screen.

Also refer to: Alternate Setpoint; Auxiliary Input; Local Setpoints; Profiler; Remote Setpoints; Setpoint and Setpoint Select.

Manual Loop Alarm Time

The loop alarm time used is manually set whenever a loop alarm is defined to have a manually set time, or if P, PD or On-Off control is selected. This parameter determines the duration of the output saturation condition after which the loop alarm will be activated.

Also refer to: Loop Alarm; On-Off Control; PD; PI and PID.

Manual Mode

Manual Mode operates as follows:

The setpoint legend is replaced by the word **MAN** and setpoint value is replaced by a % output power value. This value may be adjusted using the keypad or via serial comms. The power value can be varied from 0% to 100% for controllers using single control type, and -100% to +100% for controllers using dual control type. Switching between automatic and manual modes is achieved using “bumpless transfer”.

Auto/manual mode can be selected from the control configuration sub-menu or via a digital input if one has been configured for this function. Alternatively, if enabled in the display configuration sub-menu, the user can switch between automatic and manual control from operation mode. It is possible to use a controller as a permanent “Manual Station” by permanently selecting manual control in the control configuration sub-menu.

Caution: Manual Mode should be used with care because the power output level is set by the operator, therefore the PID algorithm is no longer in control of the process. Manual mode also ignores any output power limits, valve open/close limits and the control enable/disable setting. The operator is responsible for maintaining the process within safe limits.

Also refer to: Bumpless Transfer; Control Configuration; Control Type; Operation Mode; PID; Power Output Limits and Serial Communications.

Manual Reset

Used to manually bias proportional outputs to compensate for control deviation errors due to process load variations. It is expressed as a percentage of output power. This parameter is not applicable if the primary output is set to On-Off control. If the process variable settles below setpoint use a higher value to remove the error, if the process variable settles above the setpoint use a lower value.

For PID or PI control, typically set manual reset to approximately 80% of power needed to maintain setpoint, although lower values can be used to inhibit start-up overshoot. Integral action will automatically remove any control deviation error.

Also refer to: Control Deviation; Integral Action; ON/OFF Control; PI Control; PID; Proportional Control; Process Variable; and Setpoint.

Master & Slave Controllers

The terms Master and Slave are often used in relation to serial communications. This instrument can be a communications slave if an Ethernet or RS485 module is fitted.

With RS485 it can also act as a setpoint master or slave in multi-zone applications. In this case, one instrument controls the setpoint of one or more others. This could be a simple master/slave application where the master controller transmits its setpoint to the slaves so that all operate at the same temperature. Alternatively, an offset can be applied to each zone using the slave's setpoint offset parameter, so each is offset slightly from the master.

A similar master/slave relationship can be achieved if the master retransmits its setpoint as an analogue signal. In this case, the slave controllers must have matching remote setpoint inputs so that they can follow the masters' setpoint value. It is possible to apply an offset to each zone if the slave has an RSP offset parameter. If not the remote setpoint input scaling can be adjusted to achieve the offset.

Cascade Control is another type of Master & Slave application where the slaves setpoint is set using the master controllers PID power output.

Also refer to: Cascade Control; Linear Output; Retransmit Output; Remote Setpoint; Auxiliary Input Offset; Serial Communications and Setpoint.

Modbus RTU

Modbus RTU is the serial communications protocol used on instruments fitted with the RS485 Communications module into option slot A. Alternatively, the Modbus TCP protocol is available if the Ethernet communications module is fitted.

Modbus RTU is a Master/Slave protocol. Only the Master may initiate communications. Each slave is given a unique address, and the message contains the Modbus address of the intended slave. Only this slave will act on the command, even though other devices might receive it (an exception is “broadcast commands” sent to address 0, which are acted upon by all slaves). The commands can instruct the slave to change values in its memory registers, or ask it to send back values contained in the registers. Each query or response message includes a cyclic redundancy check (CRC) checksum to ensure that it arrives uncorrupted.

This instrument can act as a slave, or it can be a “setpoint master” over RS485. In this mode the unit continuously sends its setpoint value using broadcast messages.

Refer to the Serial Communications and Modbus Parameter sections for more information.

Also refer to: Modbus TCP; RS485; Serial Communications and Setpoint.

Modbus TCP

Modbus TCP is a version of the Modbus protocol for networks such as Ethernet, which support the Internet Protocol. It is available if an Ethernet communications module is fitted into option slot A.

This instrument can only act as a Slave when using Modbus TCP. A master device initiates the communications, and the instrument only acts on the command if it has been sent to its own IP address. Modbus/TCP does not require a checksum to ensure that the message arrives intact. Apart from this, the data model and function calls used by Modbus TCP and RTU are identical; only the message encapsulation is different.

Refer to the Serial Communications and Modbus Parameter sections for more information.

Also refer to: Ethernet; Modbus RTU and Serial Communications.

Minimum Motor On Time

This defines the minimum drive effort needed to initiate valve movement if the valve was previously stationary. It ensures that frictional and inertial effects are taken into account when driving the valve, and reduces the actuator switching operations when close to setpoint.

If the pulse required to position the valve would be less than the minimum on time, the output is suppressed. Each of these short pulse times is accumulated until their value exceeds the minimum on time, and the output is turned on for this time.

When the control deviation error is inside a “neutral zone”, the PID algorithm inhibits integration in order to avoid oscillation. The neutral zone (*symmetrical to setpoint*) is:

$$2 * \text{PropBand} * (\text{MinOnTime} / \text{MotorTravelTime})$$

Also refer to Motor Travel Time; Self-Tune and Valve Motor Drive Control.

Modulating Valve

A valve that can be positioned anywhere between fully closed and fully open by means of an incorporated motor. A typical application would be controlling temperature in a furnace heated by gas burners. The controller moves the valve to the desired position in order to control the gas flow.

If the valve motor is directly driven with Open and Close outputs from the controller feeding power to the motor, valve motor drive (VMD) control mode must be used. Some modulating valves have positioning circuitry incorporated that requires linear (mA or VDC) signals to set the position. These use the standard control mode (using PI control) instead of VMD mode.

Also refer to Linear Outputs; PI Control and Valve Motor Drive Control.

Motor Travel Time

The Motor Travel Time parameter is used in Valve Motor Drive control mode. It must be set to the time the valve takes to travel from one physical end stop to the other. This time is used by the VMD algorithm when calculating how long to energise the “Valve Open” or “Valve Close” outputs in order to bring the process on to control.

It is important that the time set accurately reflects the time taken to travel between the physical limits, otherwise the control can be severely impaired. The motor travel time may be stated in your valve supplier’s specification or the valve can be timed from the fully closed to fully opened position. The controller can be placed in Manual Mode to assist with the timing of valve movement.

Also refer to Manual Mode Enable

Multi-Point Scaling

If the process input is connected to a linear input signal, multi-point scaling can be enabled in the input configuration sub-menu. This allows the linearization of non-linear signals.

The scale input limits define the values shown when the input is at minimum and maximum values, and up to 15 breakpoints can scale input vs. displayed value between these limits. It is advisable to concentrate the break points in the area of the range that has the greatest amount of non-linearity, or the area of particular interest in the application.

Also refer to: Input Configuration; Linear Input; Process Input; Scaled Input Lower Limit and Scaled Input Upper Limit.

mVDC

This stands for millivolt DC. It is used in reference to the linear DC millivolt input ranges of the main process inputs. These can be 0 to 50mV or 10 to 50mV

Also refer to: Input Range; Linear Input; mADC; Process Variable and VDC

On-Off Control

When operating in On-Off mode, the control output(s) turn on or off as the process variable crosses the setpoint in a manner similar to a simple thermostat. Some oscillation of the process variable is inevitable when using on-off control. The amount of oscillation is mainly defined by the process characteristics, but is also affected by the on-off differential setting. On-off control can be implemented only with Relay, Triac or SSR driver outputs. It can be assigned to the primary output alone (secondary output not present), primary and secondary outputs or to a secondary output only (with the primary output set for time proportional or continuous control). On-off Control is selected by setting the corresponding proportional band(s) to on-off.

Also refer to: Continuous Control; On-Off Differential; PID; Process Variable; Primary Proportional Band; Secondary Proportional Band; Relay; Setpoint; SSR Driver; Time Proportioning Control and Triac.

On-Off Differential

A switching differential, centred about the setpoint, when using On-off control. Relay 'chatter' can be eliminated by proper adjustment of this parameter, but too large a value may increase process variable oscillation to unacceptable levels. On-off differential is also known as hysteresis or deadband.

Also refer to: Input Span; On-Off Control; PID Sets; Process Variable; Relay and Setpoint

On-Off Hysteresis

- Refer to *On-Off Differential*.

Operation Mode

The mode used during normal operation of the instrument. It can be accessed from the main menu, and is the usual mode entered at power-up. The screens shown include a main screen with bar-graphs, trend views, information about the process, alarms plus optionally, selection of auto/manual control, control output disabling. Recorder and profiler information can be displayed if these features are fitted. Up to 50 configuration menu screens also can be shown in operation mode if set to do so with the PC software. In this mode screens are not protected by a lock code.

Refer to the Operation Mode information in the Configuration & Use section.

Also refer to: Bar-Graphs; Configuration Mode; Custom Display Mode; Display Configuration; Lock Codes; Main Menu; PC Software; Profiler Setup Menu; Recorder Menu and Trend Display.

Output Configuration

A sub-menu of configuration mode used to adjust the parameters that relate to the outputs. Available settings include linear output type & scaling, output usage and retransmit output scaling etc.

Boolean logical OR / AND can be used to combine alarms and/or events to a single output.

Also refer to: Configuration Mode; Logical Output Combinations and Linear Output.

Overlap/Deadband

The Overlap/Deadband parameter defines the portion of the primary and secondary proportional bands over which both outputs are active (called overlap), or neither is active (called deadband). This is entered in display units, and is limited to -20% to +20% of the sum of the two proportional bands. E.g. if the proportional bands were 2° and 8° (totalling = 10°) the maximum overlap or deadband would be ±2°. Positive values = Overlap, negative values = Deadband. The 5 PID sets for each control loop have their own overlap/deadband setting.

Overlap/deadband is not applicable if the primary output is set for on-off control or there is no secondary output. If the secondary output is set for on-off, this parameter has the effect of moving the on-off differential band of the secondary output to create the overlap or deadband. When overlap/deadband = OFF, the edge of the secondary output differential band coincides with the point at which the primary output is at 0% (off).

The effect of the Overlap/Deadband parameter is shown in the following table

Also refer to: On-Off Differential; On-Off Control; PID Sets; Primary Proportional Band and Secondary Proportional Band.

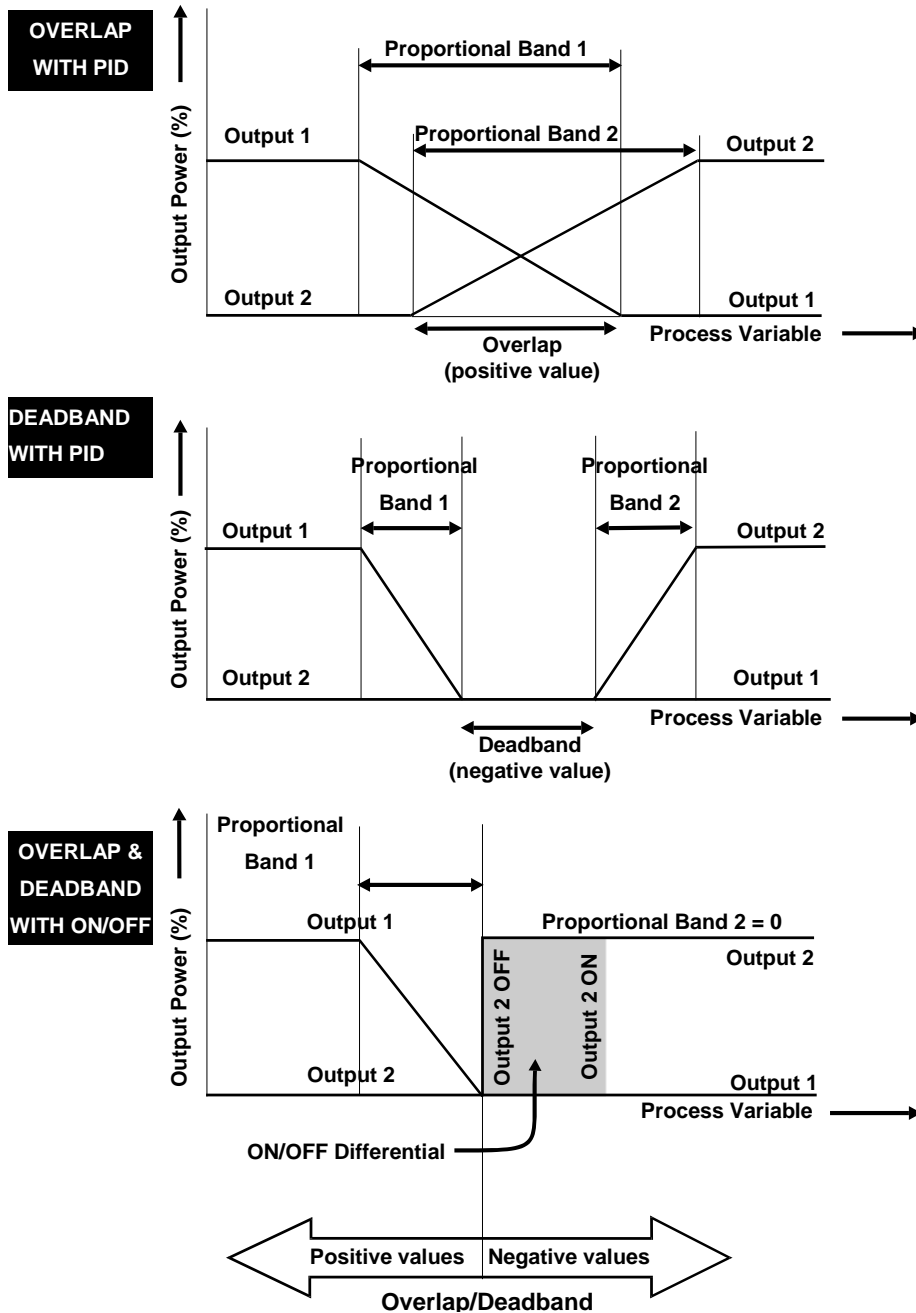

Figure 65. Overlap/Deadband

PC Software

The PC software can create, download and store instrument configurations & profiles. If the recorder feature is fitted, its recordings can be downloaded and analysed via the software. In addition, changes can be made to the instrument operation by adding extra screens, amending the contact details, alarm status labels or to the functions and labels of the LED's. The software can download a new language file, change the start-up "splash screen" or configure the "Supervisor Mode" screens. An on-screen simulation of the instrument can be setup and tested on a configurable load simulator.

Refer to the PC software and use sections of this manual for full details.

Also refer to: LEDs and Supervisor Mode.

PD Control

Proportional and Derivative (PD) control combines proportional control with derivative action. It is similar to PID control, but without Integral action.

Also refer to: Derivative; Integral; PID Control; Proportional Control and Tuning.

PI Control

Proportional and Integral Control (PI) combines proportional control with integral action. It is similar to PID Control, but without derivative action. It is often used for modulating valves, dampers or motor speed control, where derivative action can sometimes cause instability or wear of mechanical components like valves, due to excessive movement.

Also refer to: Derivative; Integral; Modulating Valve; PID Control; Proportional Control; Tuning and Valve Motor Control.

PID Control

Proportional Integral and Derivative control maintains accurate and stable levels in a process (e.g. when controlling temperature or humidity etc). Proportional control avoids the oscillation characteristic of on-off control by continuously adjusting the correcting variable output(s) to keep the process variable stable. Integral action eliminates control deviation errors, and Derivative action counters rapid process movements.

Also refer to: Control Action; Control Deviation; Control Enable; Control Type; Controller; Correcting Variable; Derivative Action; Gain Scheduling; Integral Action; Manual Mode; On-Off Control; PD Control; PI Control; PID Sets; Primary Proportional Band; Process Variable; Secondary Proportional Band; Setpoint and Tuning.

PID Gain Sets

The instrument contains PID 5 sets for each control loop, allowing the instrument to be pre-set for differing conditions. Each set has individual values for the proportional bands; overlap/deadband; on-off differential and integral & derivative times.

These values are entered in the control configuration sub menu or via the automatic tuning. The PID sets might be configured for different applications, or to allow for differing process or load conditions that might occur in a single application. In these cases one set at a time would be selected as the "Active PID" set for that loop.

The PID sets are also used by the automatic gain scheduling feature.

Also refer to: Derivative Action; Gain Scheduling; Integral Action; On-Off Control; PID; Primary Proportional Band; Secondary Proportional Band and Tuning.

PLC

This stands for Programmable Logic Controller. A microprocessor based device used in machine control. It is particularly suited to sequential control applications, and uses "Ladder Logic" programming techniques. Some PLC's are capable of basic PID control, but tend to be expensive and often give inferior levels of control.

Also refer to: PID.

Pre-Tune

The Pre-Tune facility artificially disturbs the process variable normal start-up pattern, so that an approximation of the PID values can be made prior to the setpoint being reached. During pre-tune, the controller outputs full primary power until the process value reaches the "tuning point". With Standard Pre-Tune this is halfway to the setpoint, but an alternative method allows the user to specify the process value to tune at. Pre-tune can be selected from the automatic tuning menu and will automatically disengage once complete.

If self-tune is enabled, it will be suspended while pre-tune runs. A pre-tune can be configured to run at every power up using the Auto Pre-Tune function. Refer to the Automatic Tuning section of this manual for full details.

Also refer to: Auto Pre-Tune; PID; Process Variable; Self-Tune; and Tuning.

Power Output Limits

Used to limit the correcting variable. Normally the control algorithm can set these outputs to any value between 0% and 100%. If this is undesirable in a particular application, individual settings can limit the primary power upper and lower levels and the secondary power upper and lower levels for each control loop. The upper limit values must be higher than the lower limits. These parameters are not applicable if that output is set for on-off control.

Use with caution: The instrument will not be able to control the process if the limits do not allow the outputs to be set to the correct values needed to maintain setpoint.

Also refer to: Correcting Variable; On-Off Control; PID and Setpoint.

Primary Proportional Band

The portion of the input span over which the primary output power level is proportional to the process variable value. Applicable if the control type is single or dual. For dual control a secondary proportional band is used for the second output. The control action can be direct or reverse acting, switching the direction of change in power relative to the change in PV.

Also refer to: Control Action; Control Type; Overlap/Deadband; PID; Process Variable; Secondary Proportional Band; and Tuning.

Process High Alarm

An alarm configured to as Process High will activate once the process has been above the high alarm value for longer than the alarm minimum duration time. Once activated, the level must drop below the alarm trigger point by more than the alarm hysteresis value before it will deactivate.

High alarm activation is not affected by setpoint changes or the level of control deviation.

Also refer to: Alarm Operation; Alarm Types; Alarm Duration Minimum; Alarm Hysteresis; Control Deviation; Process Variable and Setpoint.

Process Inputs

The main inputs used to monitor the process value(s) being controlled.

The input are “Universal”, supporting all common thermocouples, PT100 & NI120 RTDs, potentiometers and DC linear mV, voltage or mA signals. Linear inputs are compatible with any parameter that can be converted to a suitable electronic signal. They can be scaled into engineering units to match the process. The 2nd input can also act as an auxiliary input.

Also refer to: Auxiliary Inputs; Engineering Units; Input Span; PV Offset; Process Variable; Scaled Input Lower Limit and Scaled Input Upper Limit.

Process Low Alarm *n* Value

An alarm configured to as Process Low will activate once the process has been below the low alarm value for longer than the alarm minimum duration time. Once activated, the level must rise above the alarm trigger point by more than the alarm hysteresis value before it will deactivate.

Low alarm activation is not affected by setpoint changes or the level of control deviation.

Also refer to: Alarm Operation; Alarm Types; Alarm Duration Minimum; Alarm Hysteresis; Control Deviation; Process Variable and Setpoint.

Process Variable (PV)

Process Variables are the parameter to be controlled. Each control loop monitors its PV via one of the process inputs. PVs can be any type that can be measured by these circuits. Common types are thermocouple or RTD temperature probes, or pressure, level, flow etc from transducers that convert these parameters into DC linear input signals (e.g. 4 to 20mA). Linear signals can be scaled into engineering units using the input upper & lower limits.

Also refer to: Engineering Units; Input Span; Linear Input; Process Input; RTD; Scaled Input Lower Limit; Scaled Input Upper Limit and Thermocouple.

Process Variable Offset

- Refer to *Calibration*.

Profile Control Menu

If the profiler option is fitted, a profile control menu is available from the main menu. It allows the user to select or run a profile, and then control that profile (run, hold, abort, skip to next segment etc.).

Refer to the Profiler Control Menu information in the Configuration & Use section.

Also refer to: Main Menu; Profile Setup Menu; Profiler and Profiler Mode.

Profile Events

Events are outputs that can be made active during profile segments. Any of the five events tracks can be configured to be active or inactive for the duration of each segment, from the profile setup menu. For end segments, events selected to be stay active until the unit is powered down or a new profile runs. It is possible to logically link event and alarms to outputs with a boolean OR or AND selection.

Also refer to: Alarm Types; Logical Combinations; Profile Segments; Profile Setup Menu; Profiler and Profiler Mode.

Profile Header

The profile header contains information about how the profile starts and stops, the power loss recovery action, if the profile should repeat multiple times when run as well as whether the profile runs as a single or two loop profile.

Refer to the Profile Components information in the Profiler Option section of this manual.

Also refer to: Profile Segments, Profile Setup Menu, Profiler and Profiler Mode.

Profile Segments

Segments can be ramps, dwells, steps or special segments such as holds, loop-backs, ends or joins. A maximum of 255 segments are possible, shared amongst up to 64 profiles.

Refer to the Profile Components information in the Profiler Option section of this manual.

Also refer to: Profile Events, Profile Setup Menu, Profiler and Profiler Mode.

Profile Setup Menu

If the Profiler option is fitted, a profile setup menu is available from the main menu. It allows the user to create or edit the profile header and profile segments. Profiles can also be deleted from this menu. This menu is protected by a lock code.

Refer to the Profiler Setup Menu information in the Configuration & Use section.

Also refer to: Lock Codes; Profile Control Menu; Profile Header; Profile Segments; Profiler and Profiler Mode.

Profiler

A profiler controls the value of the actual setpoint over time; increasing, decreasing or holding its value as required. This is used in applications where the rate of rise or fall of the process variable must be closely controlled, or where a value must be maintained for a period before moving to the next value. If the Profiler is fitted, up to 64 profiles can be created with 255 segments shared amongst them. These profiles can control the setpoints for loop 1 only or both loops. Each segment can activate/deactivate the five events.

Refer to the Profiler Option section.

Also refer to: Actual Setpoint; Controller Mode; Profile Events; Profile Control Menu; Profile Header; Profile Segments; Profile Setup Menu and Profiler Mode.

Profiler Mode

This mode is entered when a profile is selected or run. The instrument will remain in profiler mode when the profile finishes or is aborted, unless the segment end type/profile abort action is set to "Use Controller Setpoint".

Also refer to: Controller Mode; Profile Control Menu; Profile Segments; Profile Setup Menu; Profiler and Setpoint.

Proportional Control

Proportional control gradually changes the correcting variable applied from 0 to 100% of the available power as the process moves through the "Proportional Band". If the control type is dual, both primary & secondary outputs available, equating to -100 to +100%. When the proportional bands are correctly tuned, the process is maintained at a steady value, avoiding the oscillation characteristic of on-off control. Proportional control is commonly used in conjunction with integral and derivative action to give PI, PD or PID control.

Also refer to: Control Type; Correcting Variable; Derivative Action; Integral Action; PD; PI; PID; Primary Proportional Band; Process Variable; Secondary Proportional Band; and Tuning.

Rate

- Refer to *Derivative Action*.

Rate of Change Alarm

An alarm based on the rate of change in the measured process variable. If the PV changes at a rate greater than the alarm level, the alarm will activate. The rate of change must be above the alarm threshold for longer than the alarm minimum duration time before the alarm will change state (from on to off, or off to on). **Caution: If the duration is less than this time, the alarm will not activate no matter how fast the rate of rise.**

Also refer to: Alarm Hysteresis; Alarm Minimum Duration; Alarm Operation; Alarm Types and Process Variable.

Ratio Control

Ratio control is where part of the process is controlled in proportion to another part. For example, it could mix two materials at a desired ratio by adjusting the flow of input 1 in relation to the flow measured by input 2. The flow of input 2 may be controlled separately, but not by the ratio loop. If two process inputs are fitted, this instrument can be configured for stoichiometric combustion control, where the fuel-air ratio is controlled for a burner.

Refer to the Ratio Control section of this manual for full details.

Also refer to: Controller; PID and Process Variable.

Recorder Configuration

If the data recorder is fitted, a recorder configuration sub-menu is added to configuration mode. This is used to adjust the recorder parameters (recording mode, sample interval, recording triggers and values to record).

Also refer to: Configuration Mode; and Data Recorder

Recorder Option

- Refer to *Data Recorder*.

Recorder Menu

If the data recorder is fitted, a recorder menu is added to the main menu. This is used to control the recording manual recording trigger, delete recordings or to show the recorder status. This menu is protected by a lock code.

Refer to the Recorder Menu information in the Configuration & Use section.

Also refer to: Lock Codes; Main Menu and Data Recorder

Relay

An electromechanical switch operated by a solenoid coil. Relays are used for alarms or, on-off/time proportioning control outputs. The limited current capacity and switching cycles of the internal relays means that they are often connected to larger external slave relays/contactors which are capable of switching much larger currents and are easily replaced once worn out. A suitably rated RC snubber should be used to suppress noise generated as they switch (refer to the noise suppression information in the Electrical Installation section).

Also refer to: Latching Relay; SSR Driver; Time Proportioning Control and Triac

Remote Setpoint (RSP)

The alternate setpoint type can be configured as a "remote" setpoint, where an analogue VDC or mADC signal applied to the 2nd input or auxiliary input A sets the controller setpoint value. The signal can be scaled to give the desired setpoint values at the inputs' minimum & maximum values, but the setpoint is always constrained by the setpoint limits. This method can also be used for cascade or multi-zone slaves.

Also refer to: Alternate Setpoint; Auxiliary Input; Auxiliary Input Lower Limit; Auxiliary Input Type; Auxiliary Input Upper Limit; Cascade Control; Linear Input; Local Setpoints; Master & Slave; mADC; Setpoint and Setpoint Select; and VDC.

Retransmit Output

A linear VDC or mADC output signal proportional to the process variable or setpoint, for use by slave controllers in multi-zone applications or external devices, such as a chart recorder or PLCs. The output can be scaled to transmit any portion of the input or setpoint span.

Also refer to: Input Span; Linear Output; mADC; Master & Slave; PLC; Process Variable; Retransmit Output Scale Maximum; Retransmit Scale Minimum; Setpoint and VDC.

Retransmit Output Scale Maximum

Scales a linear output if it has been selected to retransmit a process or setpoint value. Retransmit scale maximum defines the point at which the output will be at its maximum value. E.g. for a 0 to 5V output, it is the PV or SP value corresponding to 5V. If this parameter is set to less than the retransmit output scale minimum, the relationship between the process/setpoint value and the retransmission output is reversed so that higher PV/SP values give a lower output.

Also refer to: Process Variable; Retransmit Output; Retransmit Output Scale Minimum; Scaled Input Upper Limit and Setpoint.

Retransmit Output Scale Minimum

Scales a linear output if it has been selected to retransmit a process or setpoint value. Retransmit scale minimum defines the point at which the output will be at its minimum value. E.g. for a 0 to 5V output, it is the PV or SP value corresponding to 0V. If this parameter is set to a value greater than that for retransmit output scale maximum, the relationship between the process/setpoint value and the retransmission output is reversed so that higher PV/SP values give a lower output level.

Also refer to: Process Variable; Retransmit Output; Retransmit Output Scale Maximum; Scaled Input Lower Limit and Setpoint.

Reset To Defaults

This Configuration sub-menu selection returns all of the instruments settings back to their factory defaults. It should be used with great care, as the action cannot be undone.

Also refer to: Configuration Menu.

Reverse Acting Control

Reverse control action is required for applications where the primary control output increases the process variable, such as in a heating application. With reverse action, primary proportional outputs decrease the correcting variable as the process variable increases within the proportional band, and primary On-Off outputs turn off when the process exceeds the setpoint. The control action of a secondary output is always the opposite of the primary.

Also refer to: Control Action; Control Type; Correcting Variable; Direct Acting Control; On-Off Control and Proportional Control.

RS485

RS485 (also known as EIA-485) is two-wire, half-duplex, multi-drop serial communications connection. RS485 only defines the physical layer electrical specification, not the protocol that is transmitted across it. It uses differential signals (the voltage difference between the wires) to convey data. One polarity indicates a logic 1, the reverse polarity indicates logic 0. The applied voltages can be between +12 V and -7 volts, but the difference of potential must be > 0.2 volts for valid operation. RS485 can span distances up to 1200 metres using inexpensive twisted pair wires. Data speeds can be as high as 35 Mbit/s over 10 m and 100 kbit/s at 1200 m. This instrument supports 4800, 9600, 19200, 38400, 57600 or 115200 bps.

It is recommended that the wires be connected as series of point-to-point (multi-dropped) nodes (not in a star or ring format), with 120Ω termination resistors connected across the wires at the two ends of the network. Without termination resistors, electrical noise sensitivity is increased and signal reflections can cause data corruption. The master device should provide powered resistors to bias the wires to known voltages when they are not being driven. Without biasing the data lines float, so noise can be interpreted as data.

Converters from RS232 or USB to RS485 allow computers to communicate over RS485. Repeaters can be used to extend the distance and/or number of nodes on a network.

Also refer to: Modbus RTU and Serial Communications

RTD

Resistance Temperature Detector. A temperature sensor that changes resistance with a change in the measured temperature. This instrument supports PT100 (platinum, 100Ω at 0°C) and NI120 (nickel, 120Ω at 0°C) sensors. These have positive temperature coefficients (PTC) which means their resistance increases with higher temperatures. The temperature measured by the sensor can be displayed as °C; °F or K.

Also refer to: Input Range; Process Input and Thermocouple.

Scaled Input Upper Limit

For linear inputs, this parameter is used to scale the displayed process variable. It defines the displayed value when the process variable input is at its maximum value (e.g. if 4 to 20mA represents 0 to 14pH, this parameter should be set to 14). The value can be set from -1999 to 9999 and can be set to a value less than (but not within 100 LSDs of) the Scaled Input Lower Limit, in which case the sense of the input is reversed.

For thermocouple and RTD inputs, it is used to reduce the effective span of the input. All span related functions work from the trimmed input span. It can be adjusted within the limits of the range, but not less than 100 LSD's above the Scaled Input Lower Limit.

Also refer to: Engineering Units; Input Range; Input Span; LSD; Process Variable and Scaled Input Lower Limit.

Scaled Input Lower Limit

For linear inputs, this parameter is used to scale the displayed process variable. It defines the displayed value when the process variable input is at its minimum value (e.g. if 4 to 20mA represents 0 to 14pH, this parameter should be set to 0). The value can be set from -1999 to 9999 and can be set to a value higher than (but not within 100 LSDs of) the Scaled Input Upper Limit, in which case the sense of the input is reversed.

For thermocouple and RTD inputs, it is used to reduce the effective range of the input. All span related functions work from the trimmed input span. It can be adjusted within the limits of the range, but not less than 100 LSD's below the Scaled Input Upper Limit.

Also refer to: Engineering Units; Input Range; Input Span; LSD; Process Variable and Scaled Input Upper Limit.

Secondary Proportional Band

If the control type is set to dual, this is the portion of the input span over which the secondary output power level is proportional to the process variable value. The control action for the secondary output is always the opposite of the primary output.

Also refer to: Control Action; Control Type; On-Off Control; Input Span; Overlap/Deadband; PID; Primary Proportional Band and Tuning.

Self-Tune

Self-Tune continuously optimises tuning while a controller is operating. It monitors control deviation errors and uses them to calculate new PID values. If the controller is new or the application has changed, the initial values may be far from ideal, in which case pre-tune can be used to first establish new initial values. Self-tune will then fine-tune these values. Self-tune is suspended while pre-tune is running.

Refer to the Automatic Tuning section of this manual for full details.

Also refer to: Control Deviation; Modulating Valves. On-Off Control; Pre-Tune; PI; PID; Setpoint and Tuning.

Sensor Break Pre-Set Power

If a thermocouple or RTD is disconnected or breaks, the instrument detects the condition within 2 seconds, and sets the control loops output(s) to a value defined by the sensor break pre-set power parameter in the control configuration sub-menu. Process, band and deviation alarms behave as though the PV has gone high.

Non-zero based linear inputs (e.g. 2 to 10V or 4 to 20mA, but not 0 to 20mA) also detect sensor break conditions and set the same pre-set power value, but alarms behave as though the PV has gone low.

Also refer to: Input Range; Linear Input; RTD and Thermocouple.

Serial Communications Configuration

A sub-menu of configuration mode used to adjust the serial communications parameters (addressing, data rate, parity, master/slave settings and write enabling).

Also refer to: Configuration Mode and Serial Communications

Serial Communications Option

An optional feature that allows other devices such as a PC, PLC or master controller, to read and change instruments parameters via an RS485 or Ethernet network.

Full details can be found in the Serial Communications sections of this manual.

Also refer to: Ethernet; Master & Slave; Modbus RTU; Modbus TCP; PLC; RS485 and Serial Communications Configuration.

Set Valve Closed Position

When valve position indication is used in valve motor drive control mode, this parameter defines the input value that is measured by the 2nd input when the valve is fully closed. The valve must be driven to its "Closed" end stop before setting this parameter.

It must not be used to limit valve movement; separate Valve Close and Open Limit parameters are available for this purpose.

Also refer to Auxiliary Input; Set Valve Opened Position; Valve Close Limit; Valve Open Limit; Valve Motor Control and Valve Position Indication.

Set Valve Opened Position

When valve position indication is used in valve motor drive control mode, this parameter defines the input value that is measured by the 2nd input, when the valve is fully opened. The valve must be driven to its "Open" end stop before setting this parameter.

It must not be used to limit valve movement; separate Valve Close and Open Limit parameters are available for this purpose.

Also refer to Auxiliary Input; Set Valve Closed Position; Valve Close Limit; Valve Open Limit; Valve Motor Control and Valve Position Indication.

Setpoint

The target value at which the instrument attempts to maintain the process, by adjusting its control output power (the correcting variable). There are two setpoints for each control loop. A main local setpoint and an alternate setpoint that can be another local setpoint or a remote setpoint input from an auxiliary input. One setpoint at a time is chosen to be active using the setpoint selection, or if the profiler is fitted it can set the actual setpoint value over time. Setpoint values are always limited by the setpoint limits.

Also refer to: Alternate Setpoint; Auxiliary Input; Correcting Variable; Local Setpoints; Process Variable; Profiler; Remote Setpoint; Scaled Input Lower Limit; Setpoint Lower Limit; Setpoint Upper Limit and Setpoint Select

Setpoint Upper Limit

The maximum value allowed for setpoints, adjustable within the scaled input limits. The value should be set below any level that might cause problems in the process. If the value is moved below the current value of a setpoint, that setpoint will automatically adjust to keep it within bounds.

Also refer to: Input Span; Scaled Input Upper Limit; Setpoint and Setpoint Lower Limit.

Setpoint Lower Limit

The minimum value allowed for setpoints, adjustable within the scaled input limits. The value should be set above any level that might cause problems in the process. If the value is moved above the current value of a setpoint, that setpoint will automatically adjust to keep it within bounds.

Also refer to: Input Span; Scaled Input Lower Limit; Setpoint and Setpoint Upper Limit.

Setpoint Ramp Rate

Setpoint ramping is used to protect the process from sudden changes in the setpoint, which would result in a rapid change in the process variable. A rate is set at which the actual setpoint value ramps towards its target value, when the setpoint value is adjusted or the active setpoint is changed. The feature can be turned off by setting the ramp rate to "OFF".

To further protect the process, the initial value of the setpoint is made equal to the current process variable value at power-up, when switching back to automatic from manual control, from control disabled to enabled or after a sensor break is repaired. The actual setpoint will rise/fall from this value at the ramp rate set, until it reaches the target setpoint value.

Also refer to: Active Setpoint; Actual Setpoint; Manual Mode; Process Variable; Setpoint and Setpoint Selection.

Setpoint Selection

The setpoint select parameter in the control sub-menu defines whether the active setpoint will be the main or alternate setpoint. The choice of setpoint can also be made via a digital input or an operation mode if the selection screen has been enabled.

Also refer to: Active Setpoint; Display Configuration; Alternate Setpoint; Digital Input; and Setpoint.

Setup Wizard

A sub-set of the configuration menu parameters chosen to allow easy setup for basic applications. Users with more complex applications should select the parameters they need directly from the configuration menus.

The wizard runs automatically at the first ever power-up and exits to operation mode when completed. The wizard can be run manually from the main menu (requires an unlock code). An option to reset all parameters to default is offered when manually running the wizard.

Refer to the Setup Wizard information in the Configuration & Use section.

Also refer to: Lock Codes; Configuration Menu; Main Menu; Operation Mode and Reset to Defaults.

Solid State Relay (SSR)

An external device manufactured using two silicone controlled rectifiers in reverse parallel. SSRs can replace mechanical relays in most AC power applications. Some special SSRs can switch DC, but most cannot. As a solid-state device, an SSR does not suffer from contact degradation when switching electrical current. Much faster switching cycle times are also possible, leading to superior control. The triac option on this instrument provides is a small 1amp AC internal SSR. The SSR driver options on this instrument provide >10VDC time-proportioned pulses at the rate defined by the cycle time. When applied to the signal input of an external SSR, it causes it to pulse current from the line supply to the load. The external SSR can be any current capacity available.

Also refer to: Cycle Time; Time Proportioning Control; Relay; and Triac.

Solenoid Valve

An electromechanical device, use to control the flow of gases or liquids. Unlike a modulating valve, a solenoid valve has just two states, open or closed. Usually a spring holds the valve closed until a current passed through the solenoid coil forces it open. Standard control mode is required with a time-proportioned or on-off output for this type of valve.

Solenoid valves are often used with high/low flame burners. A bypass supplies some fuel at all times, but not enough to heat the process more than a nominal amount (low flame). A controller output opens the valve when the process requires additional heat (high flame).

Also refer to: Modulating Valves; On-Off Control and Time Proportioning Control.

Supervisor Mode

Supervisor Mode allows access to a lock-code protected sub-set of the main configuration parameters. Up to 50 configuration menu parameters can be chosen for inclusion in using the PC configuration software.

Refer to the Supervisor Mode information in the Configuration & Use section.

Also refer to: Configuration Menu; Lock Codes and PC Software.

Thermocouple

A temperature sensor made from two different metals. The thermoelectric effect generates a small signal (a few microvolts per °C) relative to the difference between the “cold” junction (at the measuring instrument) and the “hot” junction. This does mean that the wires and connectors used must match the metals used in their construction. Other issues are their nonlinearity and limited accuracy.

However, basic thermocouples are cheap to make and can measure a wide range of temperatures. While those made from more exotic materials can even withstand the very high temperatures found in furnaces.

The colour codes for the common types are shown in the Thermocouple Wire Identification Chart in the Electrical Installation Section of this manual.

Also refer to: Input Range; Process Input and RTD.

Three Point Stepping Control

Motorised modulating valves normally require a special “Three Point Stepping” control algorithm. This which provides an output to move the valve further open, or further closed whenever there is a control deviation error. When this error is zero, no further output is required to maintain control unless load conditions change. This type of control is use when the instrument is in Valve Motor Drive (VMD) control mode.

Also refer to: Control Deviation; Modulating Valve and Valve Motor Control

Time Proportioning Control

Time proportioning control is accomplished by cycling the output on and off during the prescribed cycle time, whenever the process variable is within the proportional band(s). The PID control algorithm determines the ratio of time (on vs. off) to achieve the level of the correcting variable required to remove the control deviation error. E.g. for a 32 second cycle time, 25% power would result in the output turning on for 8 seconds, then off to 24 seconds. This type of output might be used with electrical contactors, solid state relays or solenoid valves. Time proportioning control can be implemented with relay, triac or SSR driver outputs.

Also refer to: Control Deviation; Correcting Variable; Continuous Control; Cycle Time; PID; Primary Proportional Band; Relay; Secondary Proportional Band; Solenoid Valve; SSR and Triac.

Trend Displays

Trend views are a standard feature on all models. They graphically represent recent process conditions for the control loops, showing the most recent 120 out of 240 stored data points. This data can be the process variable; process variable & setpoint (shown as a dotted line) or the minimum and maximum value of the process variable measured since the last sample. The scaling adjusts automatically to the visible data. Any active alarms are indicated above the graph. The user can scroll the right hand cursor line back to examine all 240 data points. Their sample interval and data to display is set in display configuration.

Unlike the optional data recorder, trend views do not retain the stored data if the power is turned off.

Also refer to: Alarm Types; Display Configuration; Operation Mode; and Process Variable; Setpoint.

Tuning

PID Controllers must be tuned to the process in order for them to attain the optimum level of control. Adjustment is made to the tuning terms either manually, or via the automatic tuning facilities. Tuning is not required if the controller is configured for on-off Control.

Also refer to: Auto Pre-Tune; Controller; Derivative Action; Integral Action; On-Off control; PID; Pre-Tune; Primary Proportional Band; Self-Tune; Secondary Proportional Band and Tuning Menu.

Tuning Menu

The tuning menu can be accessed from the main menu. This menu is lock-code protected. It gives access to the pre-tune, auto pre-tune and self-tune facilities. These assist with PID tuning, by setting up Proportional bands, Integral and Derivative time values.

Pre-tune can be used to set PID parameters initially. Self-tune may then be used to optimise the tuning if required. Pre-tune can be set to run automatically after every power-up by enabling Auto Pre-Tune.

Refer to the Automatic Tuning information in the Configuration & Use section.

Also refer to: Auto Pre-Tune; Derivative Action; Integral Action; Lock Codes; Main Menu; On-Off control; PID; Pre-Tune; Primary Proportional Band; Self-Tune and Secondary Proportional Band.

Triac

A small internal solid state relay, which can be used in place of a mechanical relay for low power AC switching (0.1 to 1 amp AC). Like a relay, the output is time proportioned. However, as solid-state devices, triacs do not suffer from contact degradation so much faster switching cycle times are possible, offering improved control and reliability. A snubber should be fitted across inductive loads to ensure reliable switch off the triac.

Also refer to: Cycle Time; Relay; SSR and Time Proportioning Control.

USB Menu

A lock-code protected USB menu is offered from the main menu for the USB option. This allows the user to read or write files to a USB memory stick. The current configuration of the instrument can be copied to the stick, or the instrument can be reconfigured from a file created using the PC software or copied from another instrument. Profiles can also be copied from the instrument to a USB stick or you can upload pre-stored files created earlier from the PC software or copied from another instrument.

Data recordings can be copied to the stick for later analysis on a PC.

Refer to the USB Menu information in the Configuration & Use section.

Also refer to: Data Recorder; Lock Codes; Main Menu; PC Software and Profiler

Valve Motor Drive Control (VMD)

This control mode is used when directly controlling the motor of a modulating valve or damper. It uses a 3-point stepping Valve Motor Drive control algorithm to open or close the valve. VMD mode is not suitable if the modulating valve has its own positioning circuit (use standard control with a continuous current proportioned linear output) or solenoid valves (use standard control with a time proportioned output).

Also refer to: Continuous Control; Linear Output; Modulating Valve; Solenoid Valve; Three Point Stepping Control and Time Proportioning Control.

Valve Position or Flow Indication

The valve motor drive control mode does not require any kind of position feedback in order to correctly control the process. However, where potentiometer feedback or (mA or VDC) flow signals are available, they can be connected to the 2nd input to indicate valve position or flow level. The display is a percentage (0 to 100%) shown as a bar-graph in the main operator mode screen.

Even if position feedback is provided, it is not used by the VMD control algorithm when positioning the valve, thus avoiding problems associated with faulty feedback signals.

Also refer to Auxiliary Input; Bar-graph; Display Strategy; Open Loop VMD; PID; Set Valve Closed Position; Set Valve Open Position; Setpoint; and Valve Motor Control.

Valve Open & Closed Limits

When valve position indication is used in VMD control mode, the valve limit parameters can be used to “clamp” the maximum and minimum valve positions. The controller will not attempt to drive the valve past these points.

The position indication input must correctly scaled using “set valve open” and “set valve closed” before using the valve limits.

Also refer to Set Valve Closed Position; Set Valve Open Position; Valve Motor Control and Valve Position Indication.

22 PC Software

The primary function of the software is to create, download and store instrument configurations and profiles. If the data recorder feature is fitted, its recordings can be downloaded and analysed via the software.

There are several extra features that are only possible via the software.

Changes can be made to the operation of the instrument by adding extra screens into operation mode, enabling and configuring a “Supervisor Mode”, as well as changing the contact details, alarm status labels or the functions and labels of the front LED’s.

You can download a new language file or customise the controller by changing the start-up “splash screen”.

An on-screen simulation of the instrument can be setup and tested on a configurable load simulation prior to downloading the settings to an instrument.

An additional software tool is available to set the IP address required for the Modbus TCP communications option - *refer to the Network Configuration section on page 238.*

Using the PC Software

The menus and button bar are used to select the main parameter screens or one of the other modes or functions. Hover the mouse over the parameter description or value to view a fuller description. Consult the comprehensive help (available from the Help Menu) for information about the general software functions.

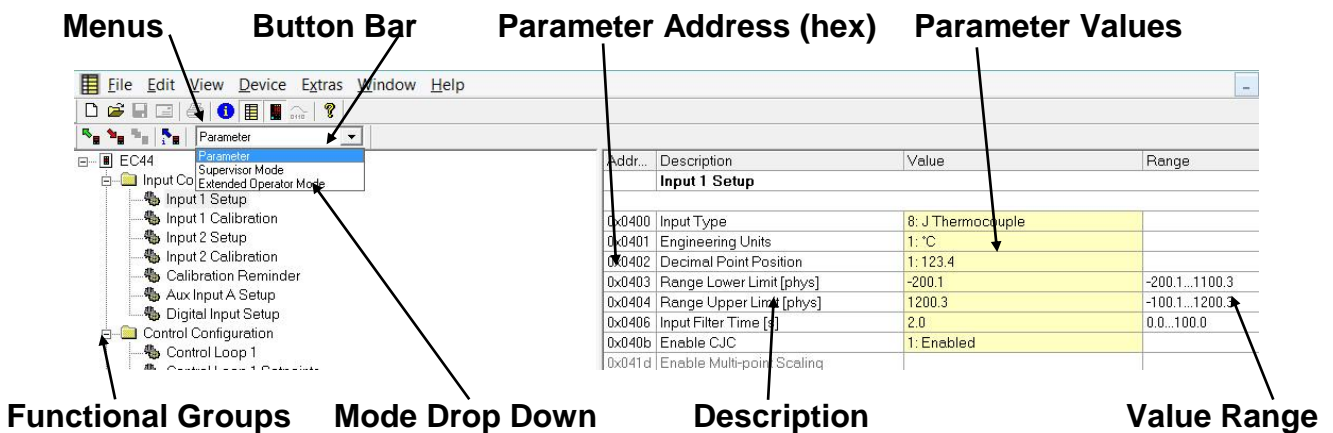

Figure 66. Main Parameter Screen

The main parameter screen is used to change the configuration and other instrument settings. This screen also allows access to the Supervisor and Enhanced Operation Mode configuration screens from the Mode drop-down list. *Refer to the relevant sections of this manual for full information on the various instrument modes and parameters.*

The Button bar, Device and View menus are used to access the other software functions.

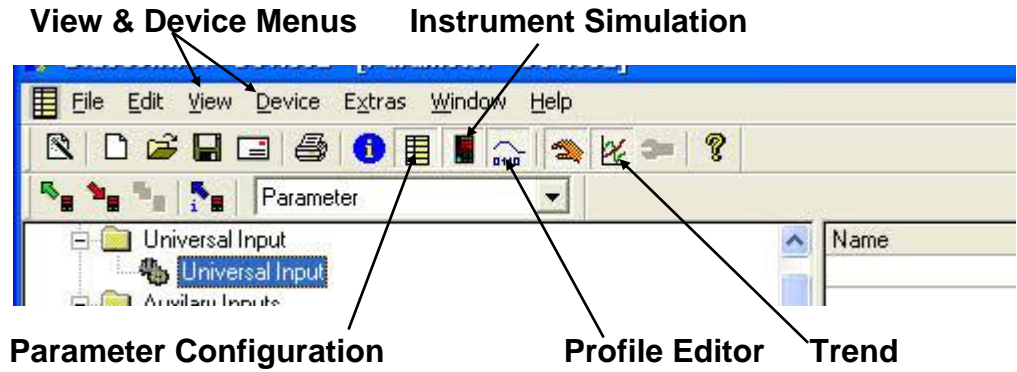

Figure 67. Button Bar & View Menu

Instrument Simulation

The software has a fully functional and interactive instrument simulation that includes a configurable simulated process, allowing the instrument settings to be tested before use.

Inputs are simulated in the top panel. A value (in display units) entered in INP1 & INP2 will override the values from the simulated processes or for a linear inputs, a mA or VDC value preceded by # (e.g. #12.0) can be used to verify the scaling. Enter F to simulate a sensor break. Tick boxes simulate the digital inputs. Active analogue and digital outputs are indicated in the lower panel. The simulated instrument can also be accessed and configured by pressing its “buttons” with your mouse, or by using the 4 arrow keys on your keyboards.

The screenshot shows the 'Simulation - EC44 Setup.bct' window. On the left, there are input fields for INP1 (124.8) and INP2 (72), and digital input checkboxes (di C1-C8). Below are output indicators for OUT 1-7. On the right, there is a control panel with 'WEST' branding, two loops (LOOP 1 and LOOP 2) with values like 124.8 °C and 72.0 °C, and a set of four arrow keys for navigation.

Figure 68. West Pro-EC44 Instrument Simulation

Configuring the Connection

The software communicates with the instrument using Modbus via the RJ11 configuration socket located on the underside of the case, or via the Ethernet or RS485 options if fitted. Refer to the wiring section for connection details.

The configuration socket is intended for initial configuration before installing the instrument in the application. An RS232 to TTL lead (available from your supplier) is required to connect this socket to your PC's RS232 serial port or USB to RS232 adaptor.

A front mounted USB port is available on some models; this can also be used to configure the instrument or transfer profile files, via a USB memory stick.



CAUTION: The configuration lead/socket is not isolated from the process input or SSR Driver outputs. It is not intended for use in live applications.

A communications settings screen is shown whenever the user attempts to connect to the instrument from the software. If the settings are not in-line with the information below, the software may not be able to communicate with the instrument.

Connection from PC to Bottom Configuration Socket

When using the built-in configuration socket, set the communications parameters as shown here and in the following table.

- **Device connector** = Configuration Socket
- **PC connector** = the PC Serial Com port number you are connected to
- **Start and Stop bits** = 1
- **Data bits** = 8.
- **Parity, Bit Rate & Address** = must match settings in the table below



Note: When uploading or downloading via the bottom mounted configuration port, the required software communication settings depend on the module fitted in slot A. See the table below.

Settings		Slot A Module	Bit Rate	Parity	Address	Con nec tion fro m PC
Device connector	Bus	Slot A Empty	19200	None	1	
		Digital Input	19200	None	1	
PC connector	COM1	Ethernet Comms	9600	None	1	
Start bits	1	Auxiliary Input	4800	None	1	
Data bits	8	RS485 Comms	Must match the Communication Configuration menu settings.			
Stop bits	1					
Parity	none					
Bit rate	19200					
address	1					

to Rear RS485 Communications Option

When using the optional RS485 communications, set the parameters as shown here.

- **Device connector** = Bus
- **PC connector** = the PC Serial Com port number you are connected to
- **Start and Stop bits** = 1
- **Data bits** = 8
- **Parity, Bit Rate & Address** = must match the settings in the instruments own Communication Configuration menu.

Connection from PC/Network to Ethernet Port

When using the optional Ethernet communications, set the parameters as shown here.

- **Device connector** = Bus
- **PC connector** = Ethernet (bus coupler)
- **IP Address** = Instrument IP address*
- **Port Address** = 502.

Device connector	Bus
PC connector	Ethernet (bus coupler)
IP address	192.168.1.12
Port address	502

The supported data rates 10/100BASE-T (10 or 100 Mbps) are automatically detected.



Note: *An IP address must be set before connecting via Ethernet. Use the default address of 0.0.0.0 if your network uses DHCP, BootP or AutoIP or ask your network administrator for a valid address.

Most networks will assign the IP address automatically, but you can use the Lantronix XPort® DeviceInstaller™ tool if you need to assign or change the IP address manually. For the latest version, go to: www.lantronix.com/device-networking/utilities-tools/device-installer.html

Changing the IP Address

Connect the instrument to your network by plugging an Ethernet cable into the top mounted RJ45 socket. Run the DeviceInstaller™ tool from a PC on the same network. The tool should automatically find this and any other controllers on the network. If not use the search button.



The existing IP and Hardware (MAC) addresses are shown for the instruments found.

Click the Assign IP button and enter the correct hardware address from the list (if necessary, confirm the number by comparing the hardware address with the number printed on Ethernet adaptor label).

At the next screen, choose whether to obtain the IP address automatically or to enter a specific address. For automatic addresses, select the protocols supported on your network (DHCP, BootP or AutoIP). For a specific address, enter the address, sub-net mask and default gateway information. Your network administrator will be able to provide this information. Press the assign button to confirm.

It is recommended to keep all other Ethernet device settings at the default values. If you do change the internal interface transfer speed or parity, matching settings must be made to the instruments Modbus data rate and parity settings in the communications configuration menu.



Note: You can enter any valid IP address, perhaps for use in another location, but if the number used does not match your existing network settings, further communication with the instrument will cease.

USB Memory Stick Folders & Files

If a USB flash drive is used to transfer files between instruments and/or the software, the files must be stored in specific **DEVICE**, **CONFIG** and **PROFILE** folders. When saving files from the software to the USB stick, always ensure they are saved to the correct folder. Local file storage on your PC can be in any location. The USB option also limits the file name to 8 characters plus the 3 digit .bct or .pfl extension. Longer file names will be truncated.

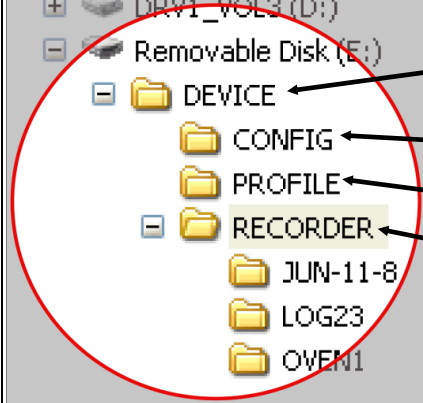

DEVICE – This folder must be located in the Root of the USB memory stick

CONFIG – Configuration files (*.bct)

PROFILE – Profile program files (*.pfl)

RECORDER – Recorder log folders/files. *These can be created or saved from the PC software.*



CAUTION: When saving a file, the data will be overwritten if the file name already exists.

Instrument Configuration

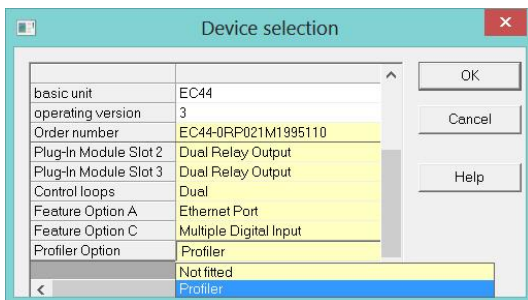

When creating a new configuration with the software, the basic instrument type and the options fitted to it must be defined in the Device Selection screen. You can select these from the drop down lists or by typing the full model number in the Order number field.



Note: *Note: It is important that the options selected match those fitted to your unit.*

Alternatively the complete instrument type and existing configuration can be uploaded to the PC from your instrument, via the configuration socket or serial communications. A previously saved configuration file can be opened from the file open menu or button.

Main Parameter Adjustment

The main parameter screen contains the configuration settings broken down into functional groups similar to the instruments' menus. The parameters can be changed in the yellow Value column. Type in new values or select from the list offered. Invalid values will be highlighted in red (possible values are show to the left). Parameters are "greyed out" if they are inaccessible due the hardware not being fitted or if they are disabled by other settings.

Once the required changes are made, the configuration can then be download to the instrument or saved to hard disk or a USB stick, with a .bct file extension. The file contains the device information and configuration parameter settings, including any supervisor and enhanced operation mode screens or changes to the LED functions. Transfer of comms settings and clock date/time are via optional tick boxes on the download settings screen. Profiles, splash screens language files and data recordings are not saved in the .bct file. They are uploaded/saved separately.

Extending Functionality via Software

LED Functions & Labels

The allocated functions and descriptive labels for the 4 LED indicators can be changed with the PC software, replacing the default PRI; SEC; TUNE; ALARM functions. These parameters can be found in the LED settings section of the software's Display Configuration functional group.

LED 1 to 4		LED LABELS (<i>max 5 characters</i>)
------------	---	--

Possible functions for each of the LEDs are: Loop 1 or 2 primary/secondary/valve control output indication (output ON = LED ON), or driving them from a logical OR combination of the alarm/profile event/digital inputs/auto-tune status/manual mode. This logical combination can be inverted to create a logical NOR function for the LEDs.

The user can create new 5 characters LED labels for the main and alternate language.

Alarm Status Screen Labels

The titles "Alarm *n*" used in the alarm status screen can be replaced with the software. Two separate sets of 8 characters labels can be entered for each of the seven alarms. One label set is used when the main display language has been selected, the other is used when the alternate language is in use.

Configuring the Supervisor Mode

The purpose of the supervisor mode is to allow selected operators access to a "lock-code" protected sub-set of the configuration parameters, without giving them the higher level configuration menu unlock code. Up to 50 configuration parameters can be selected for inclusion in the supervisor mode screen sequence. If the parameter is normally displayed on screen with another parameter, both parameters will appear.

It is not possible to configure supervisor mode screens without using the software.

To define these screens, first select Supervisor Mode from the mode drop-down list, then select the functional group containing the parameter to be added. Highlight the parameter name and click the Add Entry button. The Move Entry Up and Down buttons are used to change the order which the parameters will appear in the instruments' Supervisor Mode. Unwanted entries can be highlighted and deleted with the Remove Entry button.

Configuring Custom Display Screens for the Extended Operator Mode

Users can access a sub-set of the configuration parameters at the end of the normal operation mode if this additional screen sequence is defined from the software. Up to 50 parameters from configuration menus can be selected for inclusion in the screen sequence. If the parameter is normally displayed on screen with another parameter, both parameters will appear.

It is not possible to configure custom display screens without using the software. To define these screens, first select Extended Operator Mode from the mode drop-down list, then select the functional group containing the parameter to be added.

Highlight the parameter name and click the Add Entry button. The Move Entry Up and Down buttons are used to change the order which the parameters will appear at the end of the normal operator screens.

Unwanted entries can be highlighted and deleted with the Remove Entry button.



Note: Any parameters copied into the custom display screens are not password protected. They can be freely viewed and adjusted by anyone with access to the instrument keypad.

Functional Groups Mode Drop Down Parameter List Selected Parameters

Addr...	Description
Control Loop 2	
0x1139	Startup Control ON/OFF
0x1138	Startup Auto/Manual
0x113a	Control Type
0x113b	Primary Control Action
0x1173	PID Set Selection
Set 1 (Default)	
0x113c	Primary Proportional Band [phys]
0x113d	Secondary Proportional Band [phys]
0x113e	Integral Time Constant [s]
0x113f	Derivative Time Constant [s]
0x1141	Overlap [%]
0x1144	Primary Output ON/OFF Differential [%]
0x1175	Set1 - Breakpoint [phys]
Set 2	
No.	Description
1	Alarm 2 - Alarm Value
2	Control Loop 1 - Primary Proportional Band [phys]
3	Control Loop 1 - Integral Time Constant [s]
4	Control Loop 1 - Derivative Time Constant [s]
5	Control Loop 2 - Primary Proportional Band [phys]
6	Control Loop 2 - Integral Time Constant [s]
7	Control Loop 2 - Derivative Time Constant [s]
8	

Add Entry Remove Entry Move Up Move Down

Figure 69. Supervisor/Enhanced Operation Mode Configuration

Changing the Start-up Splash Screen

The graphic shown during the instrument start-up sequence can be changed by selecting the Download Splash Screen option from the Device menu. Choose your new graphic file (most common graphic file types are supported).

The chosen image will be converted to monochrome and be rescaled to 160 pixels wide by 80 pixels high. For best results, the image should be simple and have an aspect ratio of 2:1. Complex graphics with multiple colours or greyscales will not reproduce well. A preview of the results is shown. Click the Download button to store it to the instrument.

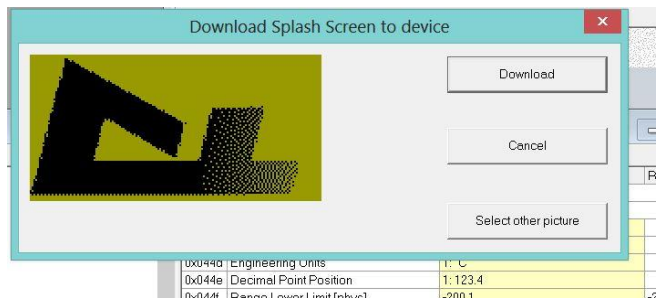

Changing the Alternate Display Language

The alternate language can be changed by selecting the Download Language File option from the Device menu. Choose the correct file (language files have a .bin extension) and click the Open button to store it to the instrument.

Ask your supplier for a copy of the latest language file.

Profile Creation and Editing

Select the Profile Editor from the button bar or view menu. An existing profile file can be opened from the file open menu or button, or uploaded from an instrument connected to the PC via the configuration socket or serial communications module. The new profile can be download to the instrument or saved to disk with a .pfl file extension.



CAUTION: Take care to preserve any profile joins when editing or uploading profile files to an existing configuration. Joins are based on the profile numbers. Ensure profiles is uploaded to the correct location.

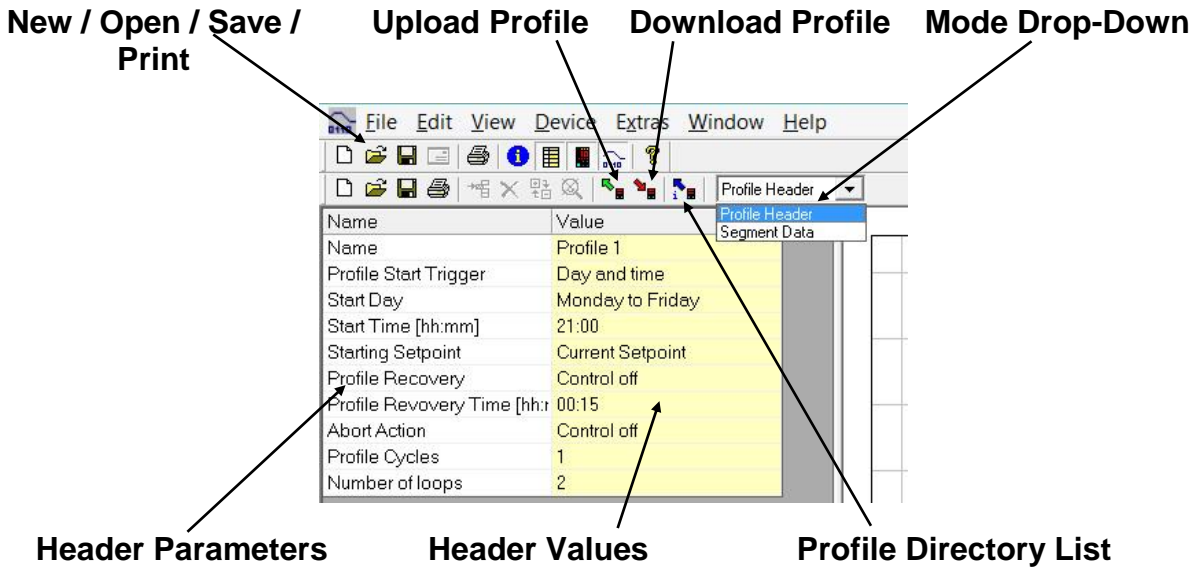
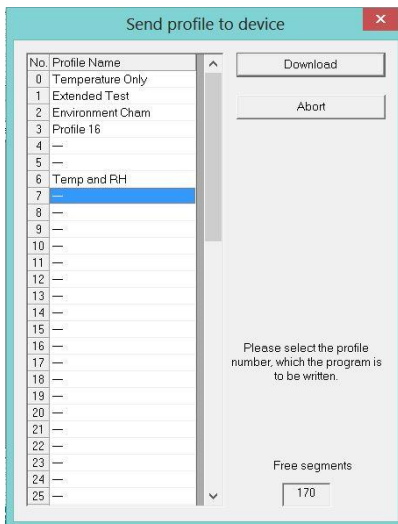

Figure 70. Profile Editor – Header



If the option to upload a profile is chosen, a list of profiles in the connected instrument is shown. The user can select the required profile from the list.

A directory of existing profiles in the instrument can also be requested. This allows one or all of the profiles to be deleted.

When downloading a profile to the instrument via the configuration socket or over serial communications, a list of existing profiles and empty profile slots is displayed. The user can select where to place the profile (a warning is shown if the profile will overwrite an existing profile).

The number of available free segments is also shown.

A drop-down menu switches between the Profile Header and Segment Data. Refer to the *Profiler Setup Menu and Profiler Option* sections for full details of the header and segment data.

Header data includes a 16-character profile name, options for starting the profile after a delay or at a specific day and time, the starting setpoint, the action to take after a power/sensor failure or profile abort, the number of times the profile will run and if one or both control loops will be controlled.

The segments are shown in Segment Data mode. The last segment type is either End, Join or Repeat Sequence, and cannot be deleted. The user can change any segments' type and values, or insert additional segments before the selected one. A dynamically scaled graphic shows the setpoint(s) for each segment of the profile, with the current selected segment highlighted in red. The five profile events are shown below the graph.

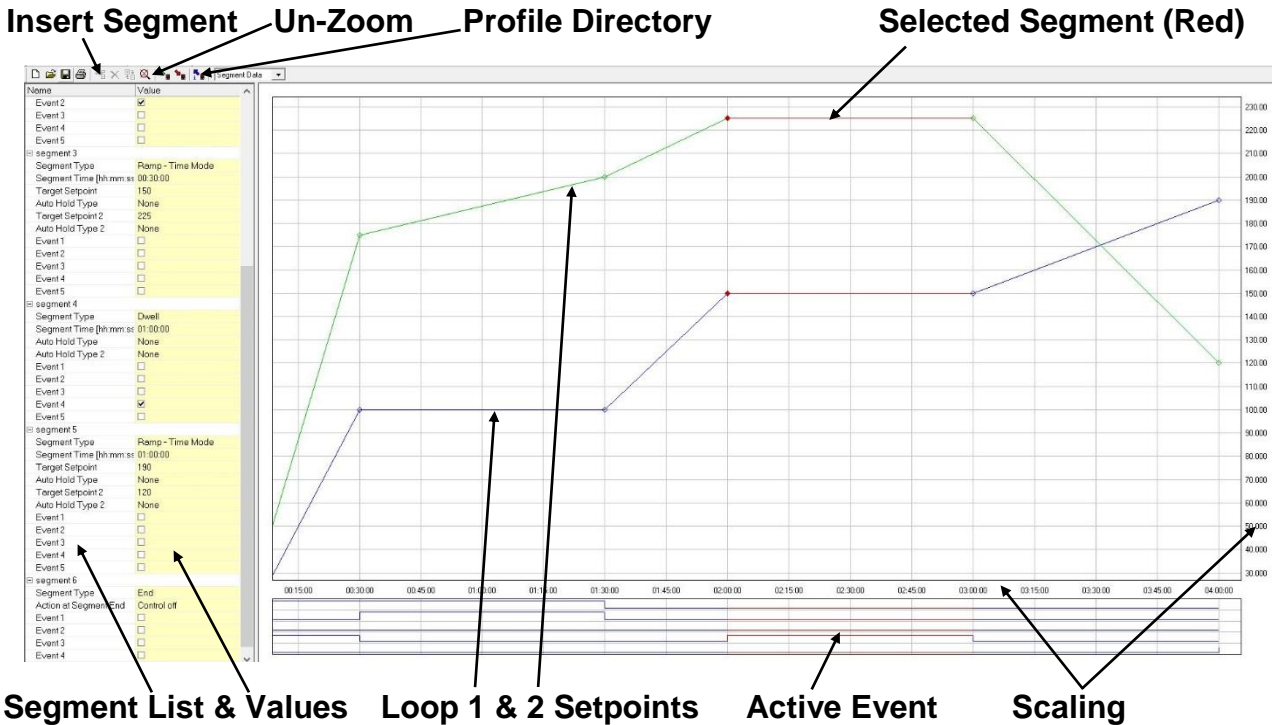

A hard copy of the profile, including the graph and events can be printed from the File | Print menu.

Data Recorder Trend Upload & Analysis

Uploading Data

Recordings can be transferred to a memory stick using the optional USB Port, or they can also be uploaded directly to your PC or network with the software, via the configuration port or RS485/Ethernet communications if fitted. To upload from a connected instrument, go to the Device | Upload recorder Data menu in the software. Select a folder location and enter a file name when prompted, then click Save. Enter the communications parameters for your connection, and click OK to save the data in Comma Separated (.csv) format.

Analysing Data

The data can be opened and analysed with the PC software, or with any spreadsheet. It can also be imported into other software that can interpret a .csv file.

To analyse a recording file in the PC software, go to the File | Open Trend menu. Locate and open the .csv file. The recording opens with the analogue traces (process, power or setpoint values) in the main window at the top, and digital traces (alarm or events statuses) below.



Note: Analysis with the PC software is limited to 8 analogue channels, so only the first 8 will be displayed. The number of recorded alarms & events is not limited.

The settings button allows trend data channels to be made visible/invisible, or change their colour and scaling. Click & drag your mouse over an area of interest to zoom in (use the un-zoom button to cancel) or move the cursor line to that area to see the instantaneous analogue values and the alarm & event statuses.

Enable Cursor **Un-Zoom** **Settings** **Cursor Line** **Trend Settings**

Status/Value at Cursor **Analogue Traces** **Alarms/Events** **Visibility & Format**

The screenshot shows a main window titled '000001-1.CSV' with a graph of two data series (PV and PV 2) over time. A vertical cursor line is positioned at a specific point on the graph. A 'Settings' dialog box is open, showing options for cycle time, alarm status, and visibility. The dialog includes a table for channel settings:

Setting	Value
Cycle time	950 ms (0 min)
At end of recording	Overwrite old data
Left scale	---
Right scale	PV 2
Time scale	absolute

Below this table is another table for channel visibility and format:

Name	Visible	Title	Color	Min	Max
e1: PV	<input checked="" type="checkbox"/>	PV	Green	0.000	1000.0
e2: PV 2	<input checked="" type="checkbox"/>	PV 2	Red	0.000	1000.0
a1: Alarm 1 Status	<input checked="" type="checkbox"/>	Alarm 1 Status	Black		
a2: Alarm 2 Status	<input checked="" type="checkbox"/>	Alarm 2 Status	Black		
a3:	<input checked="" type="checkbox"/>				

Project Documentation

The Project information (file name, instrument model code and version, modules / options fitted) and other user entered information such as the project name and version, operator details, creation and modification dates and a text description of the project can be entered into the file.

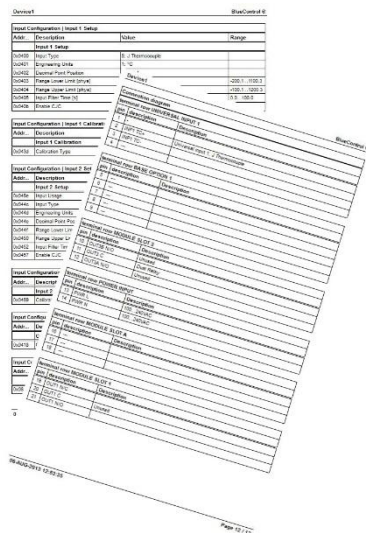
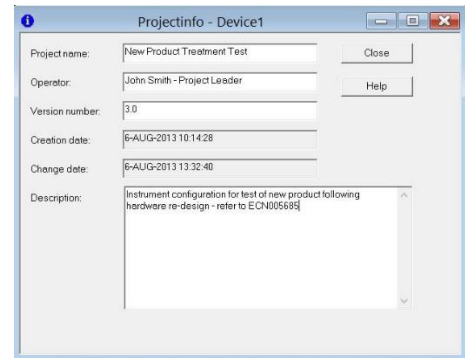

A hard copy of the instrument configuration can be printed from the File | Print menu.

This includes the project information, configuration parameters and their values, the Modbus parameter addresses, supervisor mode screens and the terminal wiring for your hardware/configuration.

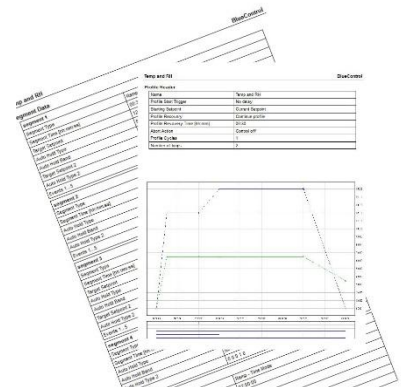

Profile information can also be printed. The profile header and segment data is listed along with a graphical representation of the profile.

23 Specifications

Reference Test Conditions

Ambient Temperature:	20°C ±2°C.
Relative Humidity:	60 to 70%.
Supply Voltage:	100 to 240V AC 50Hz ±1%.
Source Resistance:	<10Ω for thermocouple input.
RTD Lead Resistance:	<0.1Ω/lead balanced (Pt100).

Universal Process Inputs

General Input 1 and 2 Specifications

Input Sample Rate:	100mS (Ten samples per second)	
Input Filter Time	0.0 (OFF), 0.1 to 100.0 seconds in 0.1 second increments.	
Input Resolution:	16 bits. Always four times better than the display resolution.	
Supply Voltage:	Negligible effect on readings within the specified supply tolerances.	
Humidity Influence:	Negligible effect on readings if non-condensing.	
Temp. Stability:	Error <0.01% of span per °C change in ambient temperature.	
Input Impedance:	V DC:	47KΩ.
	mA DC:	5Ω.
	Other ranges:	Greater than 10MΩ resistive.
Isolation:	Reinforced safety isolation from outputs and other inputs.	
User Calibration:	Single or two point. +ve values are added -ve subtracted from PV.	
PV Display:	Displays process variable up to 5% over and 5% under span.	

Thermocouple Input

Thermocouple Types & Ranges

Sensor Type	Range in °C	Range in °F
B	+100 to 1824°C	+211 to 3315°F
C	0 to 2320°C	32 to 4208°F
D	0 to 2315°C	32 to 4199°F
E	-240 to 1000°C	-400 to 1832°F
J (default)	-200 to 1200°C	-328 to 2192°F
K	-240 to 1373°C	-400 to 2503°F

Sensor Type	Range in °C	Range in °F
L	0 to 762°C	32 to 1402°F
N	0 to 1399°C	32 to 2551°F
PtRh20%: PtRh40%	0 to 1850°C	32 to 3362°F
R	0 to 1759°C	32 to 3198°F
S	0 to 1762°C	32 to 3204°F
T	-240 to 400°C	-400 to 752°F



Note: Defaults to °F for USA units. Defaults to °C for non-USA units. The Scaled Input Upper Limit and Scaled Input Lower Limit parameters, can be used to restrict range. An optional decimal place can be displayed.

Thermocouple Performance

Calibration:	Complies with BS4937, NBS125 and IEC584.
Measurement Accuracy:	±0.1% of full selected input range ±1LSD (Least significant display digit). NOTE: <i>Reduced performance for B Thermocouple from +100 to 600°C.</i> NOTE: <i>PtRh 20% vs PtRh 40% Thermocouple accuracy is 0.25% and has reduced performance below 800°C.</i>
Linearization Accuracy:	Linearization better than better ±0.2°C (±0.05 typical) for J, K, L, N and T thermocouples; than better than ±0.5°C for other types.
Cold Junction:	If enabled, CJC error is better than ±1°C under operating conditions.
Sensor Resistance Influence:	Thermocouple 100Ω: <0.1% of span error. Thermocouple 1000Ω: <0.5% of span error.
Sensor Break Protection:	Break detected within two seconds. Process Control outputs go to the pre-set power value. High and Sensor Break Alarms operate.

Resistance Temperature Detector (RTD) Input

RTD Types & Ranges

Sensor Type	Range in °C	Range in °F	Sensor Type	Range in °C	Range in °F
3-Wire PT100	-199 to 800°C	-328 to 1472°F	NI120	-80 to 240°C	-112 to 464°F



Note: *The Scaled Input Upper Limit and Scaled Input Lower Limit parameters, can be used to restrict range. An optional decimal place can be displayed.*

RTD Performance

Measurement Accuracy:	±0.1% of full selected input range ±1LSD (Least significant display digit).
Linearization Accuracy:	Better than ±0.2°C any point (±0.05°C typical). PT100 Input complies with BS1904 and DIN43760 (0.00385Ω/Ω/°C).
Sensor Resistance Influence:	Pt100 50Ω/lead balanced. Automatic Lead Compensation: <0.5% of span error.
RTD Sensor Current:	150µA ±10%.
Sensor Break Protection:	Break detected within two seconds. Process Control outputs go to the pre-set power value. High and Sensor Break Alarms operate.

DC Linear Input

DC Linear Types & Ranges

Input Type	Ranges		Input Type	Ranges	
mA DC	0 to 20mA	4 to 20mA	V DC	0 to 5V	1 to 5V
mV DC	0 to 50mV	10 to 50mV		0 to 10V	2 to 10V
Potentiometer	≥100Ω				

DC Linear Performance

Display Scaling:	Scalable from -2000 to 100000 for any DC Linear input type.
Minimum Span:	100 display units.
Decimal Point Display:	Decimal point selectable from 0 to 3 places. Note: <i>Rounds to 2 places above 99.999; 1 place above 999.99 and no decimal above 9999.9.</i>
DC Input Multi-Point Linearization:	Up to 15 scaling values can be defined anywhere between 0.1 and 100% of input.
Measurement Accuracy:	±0.1% of span ±1LSD (Least significant display digit).
Maximum Overload:	1A (mA input terminals), 30V (voltage input terminals) at 25°C ambient.
Sensor Break Protection:	Applicable for 4 to 20mA, 1 to 5V and 2 to 10V ranges only. Break detected within two seconds. Process Control outputs go to the pre-set power value. Low and Sensor Break Alarms operate.

Input Functions

Function	Input 1	Input 2
Process Control	Loop 1	Loop 2
Cascade Control	Master Loop	Slave Loop
Ratio Control	Controlled Variable	Un-controlled Variable
Remote Setpoint (RSP)	-	RSP for loop 1
Valve Position Feedback	-	Valve Position for loop 1



Note: *RSP Linear inputs only, scalable between -9999 to 10000, but actual setpoint value is kept within the setpoint limit settings.*

Auxiliary Input

Auxiliary Input A Types & Ranges

Input Type	Ranges	
mA DC	0 to 20mA	4 to 20mA
V DC	0 to 5V	1 to 5V
	2 to 10V	0 to 10V





Auxiliary Input Performance

Input Sampling rate:	4 samples per second.	
Input Resolution:	16 bit ADC.	
Input Function:	Scalable as a Remote Setpoint (RSP) between ±0.001 & ±10000 Scaled input value used for setpoint (<i>but constrained by setpoint limits</i>).	
Measurement Accuracy:	±0.25% of input span ±1LSD (Least significant display digit).	
Input Resistance:	V DC:	47KΩ
	mA DC:	10Ω
	Other ranges:	Greater than 10MΩ resistive
Input protection:	Voltage input: will withstand up to 5x input voltage overload without damage or degradation of performance in either polarity. Current input: will withstand 5x input current overload in reverse direction and up to 1A in the normal direction.	

Isolation:	Reinforced safety isolation from outputs and inputs
Sensor Break Detection:	Applicable for 4 to 20mA, 1 to 5V and 2 to 10V ranges only. Control goes to the pre-set power value if Auxiliary Input is providing the active setpoint source.

Digital Inputs

Digital Input Functions

Function	Logic High*	Logic Low*
<input type="checkbox"/> Loop 1 Control Select	Enabled	Disabled
<input type="checkbox"/> Loop 2 Control Select	Enabled	Disabled
<input type="checkbox"/> Loop 1 Auto/Manual Select	Automatic	Manual
<input type="checkbox"/> Loop 2 Auto/Manual Select	Automatic	Manual
<input type="checkbox"/> Loop 1 Setpoint Select	Main SP	Alternate SP
<input type="checkbox"/> Loop 2 Setpoint Select	Main SP	Alternate SP
<input type="checkbox"/> Loop 1 Pre-Tune Select	Stop	Run
<input type="checkbox"/> Loop 2 Pre-Tune Select	Stop	Run
<input type="checkbox"/> Loop 1 Self-Tune Select	Stop	Run
<input type="checkbox"/> Loop 2 Self-Tune Select	Stop	Run
<input type="checkbox"/> Profile Run/Hold	Hold	Run
<input type="checkbox"/> Profile Hold Segment Release	No Action	Release
<input type="checkbox"/> Profile Abort	No Action	Abort
<input type="checkbox"/> Data Recorder Trigger	Not Active	Active
<input type="checkbox"/> Output <i>n</i> Forcing Open/Close	Off/Open	On/Closed
<input type="checkbox"/> Clear All Latched Outputs	No Action	Reset
<input type="checkbox"/> Output <i>n</i> Clear Latch	No Action	Reset
<input type="checkbox"/> Key <i>n</i> Mimic (for    )	No Action	Key Pressed
<input type="checkbox"/> Inputs C1-C7 can be used as Binary or BCD Profile Selection	Binary 0	Binary 1



Note: The above actions apply when a digital input is setup to control the specified function(s), *but the High/Low function can be switched using the Inputs to Invert selection screen.

Digital Input Performance

Number Available	0 to 9. One from Module Slot A, 8 from Multi-Digital Input C
Type:	Voltage-free or TTL-compatible voltage signals. Held in High state via pull-up resistors.
Logic States:	Logic High = Open contacts (>5000Ω) or 2 to 24VDC signal. Logic Low = Closed contacts (<50Ω) or -0.6 to +0.8VDC signal.
*Inverted Logic:	Inputs can be inverted. This swaps the actions listed above (e.g. Profile Aborts on Logic High if selected input is inverted).
Digital Input Sensitivity:	Inputs set for: Control disable; Auto/Manual; Setpoint Select; Pre-Tune; Self-Tune; Profile Run/Hold and Profile Hold Segment Release are all Edge Sensitive , where a High-Low or Low-High transition changes the function status. Pre-Tune is always off at power on (except if using the auto pre-tune feature), but others functions retain their power off status at power on. Inputs set for: Profile Abort; Data Recorder Trigger; Output Forcing; Clearing Latched Outputs; Key Mimic and Profile Selection are all Level Sensitive , where a high or low input sets the function status. <i>Digital inputs generally work in parallel with equivalent menus, where either can change the function status.</i>
Response Time:	Response within <0.25 second of signal state change.
Isolation:	Reinforced safety isolation from inputs and outputs.

Output Specifications

Output Module Types

Plug-in Slot 1:	Single SPDT Relay, Single SSR Driver, Triac or DC linear.
Plug-in Slot 2:	Single SPDT Relay, Dual SPST Relay, Single SSR Driver, Dual SSR Driver, Triac or 24VDC Transmitter Power Supply.
Plug-in Slot 3:	Single SPDT Relay, Dual SPST Relay, Single SSR Driver, Dual SSR Driver, Triac or 24VDC Transmitter Power Supply.
Base Option 4 & 5:	Slot 4 SPDT Relay (<i>std.</i>). Slot 5 SPDT Relay (<i>optional.</i>)
Base Option 6 & 7:	Slots 6 & 7 DC Linear (<i>optional.</i>)

Single Relay Output 1-3 Performance

Positions	Optional in Plug-in Modules 1, 2 & 3.
Contact Type:	Single pole double throw (SPDT).
Contact Rating:	2A resistive at 120/240V AC
Lifetime:	>500,000 operations at full rated AC voltage/current. De-rate if switching DC loads.
Isolation:	Reinforced safety isolation from inputs and other outputs.



CAUTION: Plastic pegs prevent fitting of older non-reinforced single relay modules – Remove the peg to fit dual relays (all dual relay modules have reinforced isolation).

Dual Relay Output 2-3 Performance

Positions	Optional in Plug-in Modules 2 & 3.
Contact Type:	2 x Single pole single throw (SPST) relays with shared common.
Contact Rating:	2A resistive at 120/240V AC.
Lifetime:	>200,000 operations at full rated AC voltage/current. De-rate if switching DC loads.
Isolation:	Reinforced safety isolation from inputs and other outputs.

Base Relay 4-5 Output Performance

Positions	Base outputs 4 & 5.
Contact Type:	1 x Single pole single throw (SPST).
Contact Rating:	2A resistive at 120/240V AC.
Lifetime:	>200,000 operations and which contacts at full rated voltage/current. De-rate if switching DC loads.
Isolation:	Reinforced safety isolation from inputs and other outputs.

Single SSR Driver Output 1-3 Output Performance

Positions	Optional in Plug-in Modules 1, 2 & 3.
Drive Capability:	1 x Logic / SSR Driver output at >10VDC into 500Ω minimum.
Isolation:	Not isolated from the universal input, Ethernet communications or other SSR driver outputs.

Dual SSR Driver Output 2-3 Performance

Positions	Optional in Plug-in Modules 2 & 3.
Drive Capability:	2 x Logic / SSR Driver outputs* at >10VDC into 500Ω minimum. *Dual SSR Driver modules have shared positive terminal.
Isolation:	Not isolated from the universal input, Ethernet communications or other SSR driver outputs.

Triac Output 1-3 Performance

Positions	Optional in Plug-in Modules 1, 2 & 3.
Operating Voltage:	20 to 280Vrms @47 to 63Hz.
Current Rating:	0.01 to 1A (full cycle rms on-state @ 25°C); de-rates linearly above 40°C to 0.5A @ 80°C.
Non-repetitive Surge Current:	25A peak maximum, for <16.6ms.
OFF-State dv/dt:	500V/μs Minimum at Rated Voltage.
OFF-State leakage:	1mA rms Maximum at Rated Voltage.
ON-State Voltage Drop:	1.5V peak Maximum at Rated Current.
Repetitive Peak OFF-state Voltage, Vdrm:	600V minimum.
Isolation:	Reinforced safety isolation from inputs and other outputs.

Single DC Linear Output Types & Ranges

Output Type	Ranges	
mA DC	0 to 20mA	4 to 20mA

Output Type	Ranges	
V DC	0 to 5V	0 to 10V
	2 to 10V	0 to 10V TxPSU*

DC Linear Output 1, 6-7 Performance

Positions	Optional in Plug-in Module 1, and Base Options 6 & 7.
Resolution:	Eight bits in 250mS (10 bits in 1 second typical, >10 bits in >1 second typical).
Update Rate:	Every control algorithm execution (10 times per second).
Load Impedance:	0 to 20mA & 4 to 20mA: 500Ω maximum. 0 to 5V, 0 to 10V & 2 to 10V: 500Ω minimum. Short circuit protected.
Accuracy:	±0.25% of range at 250Ω (mA) or 2kΩ (V). Degrades linearly to ±0.5% for increasing burden (to specification limits).
Over/Under Drive:	For 4 to 20mA and 2 to 10V a 2% over/underdrive is applied (3.68 to 20.32mA and 1.84 to 10.16V) when used as control output
Isolation:	Reinforced safety isolation from inputs and other outputs.
0 to 10VDC Transmitter Power Supply*	Can be used to provide an adjustable 0.0 to 10.0V (regulated), up to 20mA output to excite external circuits & transmitters.

24V Transmitter Power Supply 2-3 Performance

Positions	Optional in Plug-in Modules 2 & 3.
Power Rating	1 x 24V nominal (unregulated) excitation for external circuits & transmitters. Rated at 19 to 28VDC at 20mA. Load 910Ω minimum.
Isolation:	Reinforced safety isolation from inputs and other outputs.
<i>*see Linear output (above) for adjustable 0 to 10V Transmitter Power Supply</i>	



CAUTION: Only one Transmit PSU is supported by the instrument. Do not fit in both positions simultaneously.

Communications

Supported Communication Methods

Plug-in Slot A:	RS485 or Ethernet
PC Configuration Socket	TTL socket fitted as standard beneath the case. Requires the optional PC Configuration Lead for use.
USB Port	Optional front mounted USB socket. Use with memory sticks only.

PC Configuration Socket

Functions	PC software for configuration, data extraction and profile creation.
Type:	Proprietary TTL level serial communications.
Connection	RS232 via PC Configurator Cable to RJ11 socket under case
Isolation:	Not isolated from SSR driver outputs. For bench configuration only.



CAUTION: The configuration lead/socket is not isolated from SSR Driver outputs. It is not intended for use in live applications.

RS485

Functions	Setpoint broadcast master or general communications slave to any suitable Modbus RTU master device (inc. extraction of recordings, transfer of configuration & profile files to or from the PC software).
Type:	RS485 Asynchronous serial communications module.
Connection	Locates in Option Slot A. Connection via rear terminals 16-18 (<i>refer to wiring diagram</i>).
Protocol:	Modbus RTU slave or Modbus RTU setpoint broadcast master.
Slave Address Range:	1 to 255 or setpoint master broadcast mode
Bit rate:	4800, 9600, 19200, 38400, 57600 or 115200 bps.
Bits per character:	10 or 11 (1 start and 1 stop bit, 8 data bits plus 1 optional parity bit).
Parity:	None, even or odd (selectable).
Isolation:	240V reinforced safety isolation from all inputs and outputs.

Ethernet

Functions	General communications (inc. extraction of data recordings, transfer of configuration & profile files to or from the PC software).
Type:	Ethernet communications module.
Connection	Locates in plug-in Slot A. Connection via RJ45 socket in case top.
Protocol:	Modbus TCP Slave only.
Supported Speed:	10BaseT or 100BaseT (automatically detected)
IP Address Allocation:	Via DHCP or manual configuration via PC Tool.
Isolation:	240V reinforced safety isolation from all inputs and outputs.

USB Socket

Functions	Extraction of data recordings, transfer of configuration & profiles files to or from the PC software or direct to another controller.
Targeted Peripheral:	USB Memory Stick.
Supply Current	Up to 250mA.
Connection	Locates in slot C. Provides an optional front mounted connector.
Protocol:	USB 1.1 or 2.0 compatible. Mass Storage Class.
Isolation:	Reinforced safety isolation from all inputs and outputs

Control Loop(s)

Control types	1 or 2 control loops , each with either standard PID (single or dual control) or Valve Motor Drive (3-point stepping PID control). 2 internally linked cascade loops , with standard PID (single or dual control) or Valve Motor Drive (3-point stepping PID control). 1 Ratio loop for combustion control.
VMD Feedback	Second input can provide valve position feedback or flow indication. Feedback not required or used for control algorithm.
Tuning Types:	Pre-Tune, Auto Pre-Tune, Self-Tune and Manual Tuning with up to 5 PID sets stored internally for each control loop.
Gain Scheduling	Automatically switches the 5 PID sets at user definable break-points relating to the process variable or setpoint value.
Proportional Bands:	Primary & Secondary (e.g. Heat & Cool) 1 to 9999 display units, or On-Off control.
Automatic Reset	Integral Time Constant, 1s to 99min 59s and OFF
Rate	Derivative Time Constant, 1s to 99 min 59s and OFF
Manual Reset	Bias added each control algorithm execution. Adjustable 0 to 100% of output power (single primary control) or -100% to +100% of output power (dual primary & secondary control).
Deadband/Overlap:	Overlap (+ve values) or Deadband (-ve values) between primary & secondary proportional bands for Dual Control. Adjustable In display units - limited to 20% of the combined proportional bands width.
ON/OFF Differential:	ON/OFF switching differential 1 to 300 display units.
Auto/Manual Control:	Selectable with “bumpless” transfer when switching between Automatic and Manual control.
Control Cycle Times:	Selectable from 0.5 to 512 seconds in 0.1s steps.
Setpoint Maximum:	Limited by Scaled Input Upper Limit and Setpoint Minimum.
Setpoint Minimum:	Limited by Scaled Input Lower Limit and Setpoint Maximum.
Setpoint Ramp:	Ramp rate selectable 1 to 9999 LSD's (Least significant display digits) <u>per hour</u> and OFF (infinite).

Alarms

Number of Alarms:	Seven alarms are configurable for any supported type.
Alarm Types:	Process High; Process Low; PV-SP Deviation; Band; Control Loop; Rate Of Signal Change per minute – all with optional minimum duration and start-up inhibit. Input Signal Break; % Recorder Memory Used, Control Power High, Control Power Low.
Duration & Start-up Inhibit	Process High; Low; Deviation; Band; Loop; Rate Of Change alarms have an optional start-up inhibit function and adjustable minimum duration time from Off to 9999 seconds before activation. CAUTION: If the duration is less than this time, the alarm will not activate no matter what the value is.
Alarm Hysteresis:	Adjustable deadband from 1 LSD (Least significant display digit) to full span (in display units) for Process, Band or Deviation Alarms.
Combination Alarm & Events Outputs:	Logically AND or OR any alarm or profile event (inc Profile running or ended) to switch an output. The output can be set to switch on when the condition is true , or when the condition is not true .

Profiler Option

Profile Limits:	Number of profiles = 64 maximum. Total number of segments = 255 maximum (shared by all programs).
Segment Types:	Ramp Up/Down over time, Ramp Rate Up/Down*, Step, Dwell, Hold, Loop, Join A Profile, End or Repeat Sequence Then End. <i>*Ramp Rate is not available when profile controls two loops</i>
Time-base:	All times are specified in hh:mm:ss (Hours, Minutes & Seconds).
Segment Time:	Maximum segment time 99:59:59 hh:mm:ss. Use loop-back for longer segments (e.g. 24:00:00 x 100 loops = 100 days).
Ramp Rate:	Ramp Up or Down at 0.001 to 9999.9 display units per hour.
Hold Segment Release:	Release from menu key-press, At Time Of Day or via a Digital Input.
Profile Starting Point	The first segment setpoint(s) begin from either the setpoint, or current measured input value, of the controlled loop(s)
Delayed Start:	After 0 to 99:59 (hh:mm) time delay, or at specified day(s) & time.
Profile End Action:	Selectable from: Keep Last Profile Setpoint, Use Controller Setpoint or Control Outputs Off.
Profile Abort Action:	Selectable from: Keep Last Profile Setpoint, Use Controller Setpoint or Control Outputs Off.
Power/signal Loss Recovery Action:	Selectable from: Continue Profile, Restart Profile, Keep Last Profile Setpoint, Use Controller Setpoint or Control Outputs Off.
Auto-Hold:	Off or Hold if input >Band above and/or below SP for each segment.
Profile Control:	Run, Manual Hold/Release, Abort or jump to next segment.
Profile Timing Accuracy:	0.02% Basic Profile Timing Accuracy. ±<0.5 second per Loop, End or Join segment.
Profile Cycling:	1 to 9999 or Infinite repeats per profile.
Sequence Repeats:	1 to 9999 or Infinite repeats of joined profile sequences.
Loop Back Segments:	1 to 9999 loops back to specified segment.
Segment Events:	Events turn on for the duration of the segment. If events are set on for End segments, the event states persist until another profile starts, the user exits profiler mode, or the unit is powered down.

Data Recorder Option

Recording Memory:	1Mb non-volatile flash memory (<i>data retained when power is off</i>).
Recording Interval:	1; 2; 5; 10; 15; 30 seconds or 1; 2; 5; 10; 15; 30 minutes.
Recording Capacity:	Dependant on sample rate and number of values recorded. Example: 2 values can be recorded for 21 days at 30 second intervals. More values or faster sample rates reduce the duration.
RTC Battery Type:	VARTA CR 1616 3V Lithium. Clock runs for >1 year without power.
RTC accuracy:	Real Time Clock error <1second per day.

Display

Display Type:	160 x 80 pixel, monochrome graphic LCD with a dual colour (red/green) backlight.
Display Area:	66.54mm (W) x 37.42mm (H).
Display Characters:	0 to 9, a to z, A to Z, plus @ () ß ö - and _

Operating Conditions

Location	Intended for indoor use only.
Ambient Temperatures	0°C to 55°C (operating) and -20°C to 80°C (storage).
Relative Humidity:	20% to 90% non-condensing.
Altitude:	Up to 2000m above sea level.
Supply Voltage & Power (Mains versions):	Mains Supply: 100 to 240V ±10% AC 50/60Hz. Consumption 20VA Fuse rating: 1amp type-T / Slow-blow
Supply Voltage & Power (Low voltage versions):	AC Supply: 20 to 48V AC 50/60Hz. Consumption 5VA DC Supply: 22 to 65V DC. Consumption 12W. Fuse rating: 350milliamp type-T / Slow-blow
Front Panel Sealing:	To IP66 (IP65 front USB connector). <i>IP20 behind the panel.</i> (<i>IP ratings are not tested for or approved by UL</i>)

Conformance Norms

EMI:	CE: Complies with EN61326.
Safety Standards:	CE: Complies with EN61010-1 edition 3 UL, cUL to UL61010C-1. Pollution Degree 2, Installation Category II.

Dimensions

Front Bezel Size:	¹ / ₄ DIN (96 x 96mm).
Mounting:	Plug-in with panel mounting fixing strap.
Panel & Cut-out Size:	Panel must be rigid with Max thickness 6.0mm (0.25inch). Cut-out 92mm x 92mm +0.5, -0.0mm.
Depth Behind Panel:	117mm
Ventilation	20mm gap required above, below and behind.
Weight:	0.65kg maximum.
Terminals:	Screw type (combination head).

24 Pro-EC44 Product Coding

Model Code	EC44	-	x	-	x	-	x	-	x	-	x	-	x	-	x	-	x	-	x	-	x	-	x	-	x	-	x	-	x	-	x	-	x	-	Sxxx	
Regional Defaults																																				
Non-US defaults	0																																			
USA defaults	1																																			
Controller/Recorder																																				
Controller	C																																			
Controller with USB Port	U																																			
Controller/Recorder	X																																			
Controller/Recorder with USB Port	R																																			
Profiler																																				
Not fitted	0																																			
Profiler	P																																			
Supply Voltage																																				
100-240VAC	0																																			
24-48V AC/DC	2																																			
Control Loops																																				
One Control Loop	1																																			
One Loop + Auxiliary Input	A																																			
Two Control Loops	2																																			
Base Option 1																																				
Relay Output	1																																			
Relay Output + Linear DC Output	M																																			
Base Option 2																																				
Not fitted	0																																			
Relay Output + Linear DC Output	M																																			
Plug-in Module Slot 1																																				
Not fitted	0																																			
Relay Output	1																																			
SSR Driver Output	2																																			
Linear DC Output	L																																			
Triac Output	8																																			
Plug-in Module Slot 2																																				
Not fitted	0																																			
Relay Output	1																																			
SSR Driver Output	2																																			
Triac Output	8																																			
Dual Relay Output	9																																			
Dual SSR Driver Output	Y																																			
24VDC Transmitter Power Supply	T																																			
Plug-in Module Slot 3																																				
Not fitted	0																																			
Relay Output	1																																			
SSR Driver Output	2																																			
Triac Output	8																																			
Dual Relay Output	9																																			
Dual SSR Driver Output	Y																																			
24VDC Transmitter Power Supply	T																																			
Plug-in Module Slot A																																				
Not fitted	0																																			
RS485 Serial Comms - Modbus RTU	1																																			
Single Digital Input	3																																			
Auxiliary Input A	4																																			
Ethernet Port - Modbus TCP	5																																			

Model Code	EC44 - x - x - x - x - x - x - x - x - x - x - x - x - x - x - x - x - x - x - x - Sxxx
Option C	
Not fitted	0
Multiple Digital Input	1
HMI & Manual Language	
English	1
French	2
German	3
Italian	4
Spanish	5
Packing And Manual Options	
Single Pack with Concise Manual	0
Bulk Pack with 1 Concise Manual per unit – (Minimum 20 pcs)	1
Special Variants	
Standard Model (Special features not fitted)	Blank

25 Table of Contents

Warranty and Returns Statement	ii
1 Introduction.....	1
2 Installation	2
Unpacking	2
Installation	2
Panel-Mounting	2
Cleaning	3
3 Field Upgrade Options	4
Plug-Modules and Upgradeable Functions.....	4
Preparing to Install or Remove Plug-in Modules	5
Removing/Replacing Option Modules	7
Replacing the Instrument in its Housing	7
Auto Detection of Plug-in Modules	7
Data Recorder Board	8
Profiler Enabling.....	8
4 Electrical Installation.....	9
Avoiding EMC Problems	9
Cable Isolation & Protection	9
Noise Suppression at Source	10
Sensor Placement (Thermocouple or RTD)	11
Thermocouple Wire Identification	11
Thermocouple Wire Colour CHART	11
Pre-wiring – Cautions, Warnings & Information.....	12
Connections and Wiring.....	13
Central Terminal Connections	13
Outer Terminal Connections	14
Power Connections	15
Universal Input 1 Connections.....	16
Universal / Auxiliary Input 2 Connections.....	17
Base Option 1	19
Base Option 2.....	19
Plug-in Module Slot 1 Connections	20
Plug-in module slot 2 Connections.....	21
Plug-in Slot 3 Connections	23
Plug-in Slot A Connections.....	25
Option C Connections	27
5 Powering Up.....	29
Powering Up Procedure.....	29
Front Panel Overview	29
Display	29

LED Functions.....	30
Keypad Functions & Navigation.....	30
6 Messages & Error Indications	31
Plug-in Module Problems.....	31
Sensor Break Detection.....	31
Un-Calibrated Input Detection.....	31
PV Over-range or Under-range Indication.....	31
Auxiliary Input Over-range or Under-range Indication.....	32
Cascade-Open.....	32
Profile Not Valid.....	32
USB Data Transfer Failure message.....	32
Getting Help.....	32
7 Application Setup.....	33
Pre-commissioning Considerations.....	33
8 Operation and Configuration Menus.....	36
Operation Mode.....	36
Navigating and Adjusting Values in Operator Mode.....	36
OPERATION MODE SCREEN SEQUENCE.....	37
Main Menu.....	42
Entry into the Main Menu.....	42
Unlock Codes.....	42
Main Menu Options.....	42
Setup Wizard.....	43
Manual entry to the Setup Wizard.....	43
Setup Wizard Screens.....	43
Supervisor Mode.....	44
Entry into Supervisor Mode.....	44
Supervisor Mode Screens.....	44
Configuration Menu.....	45
Entry into the Configuration Menu.....	45
Configuration Menu Screens:.....	46
Input Configuration Sub-Menu Screens.....	46
Control Configuration Sub-Menu Screens.....	50
Outputs Configuration Sub-Menu Screens.....	56
Alarm Configuration Sub-Menu Screens.....	56
Communications Configuration Sub-Menu Screens.....	57
Data Recorder Configuration Sub-Menu Screens:.....	58
Clock Configuration Sub-Menu Screens.....	59
Display Configuration Sub-Menu Screens.....	59
Lock Code Configuration Sub-Menu Screen.....	60
Reset To Defaults Sub-Menu Screen.....	60

The USB Menu	60
Entry into the USB Menu	60
USB Menu Screens	61
Recorder Control Menu	62
Entry into the Recorder Control Menu	62
Recorder Menu Screens	62
Profiler Setup Menu	63
Entry into the Profiler Setup Menu	63
🔒 Profiler Setup Menu Screens	63
Profiler Control Menu	66
Profiler Control Menu Screens	66
Service & Product Information Mode	67
Entry into Service & Product Information Mode	67
ServiceE & Product Information Screens:	67
Automatic Tuning Menu	68
Entry into the Automatic Tuning Menu	68
Automatic Tuning Menu Screens	68
Lost Lock Codes	69
9 Input Calibration & Multi-point Scaling	70
User Calibration	70
Calibration Reminder	70
Single Point Calibration	70
Two Point Calibration	71
Multi-point Scaling	72
Base Calibration Adjustment	72
Required Equipment	72
Performing a Calibration Check	73
Recalibration Procedure	73
Input Calibration Phases	73
10 Digital Inputs	75
Digital Signal Type	75
Inverting Digital Inputs	75
Soft Digital Inputs	76
Digital Input Functions	76
11 Cascade Control	78
Normal Cascade Operation	79
Cascade-Open	79
Manual Mode	79
Cascade Tuning	79
12 Ratio Control	81
13 Redundant Input	83
14 Valve Motor Drive / 3-Point Stepping Control	84

	Special Wiring Considerations for Valve Motor Control	84
	Position Feedback.....	85
	Valve Limiting	85
15	Setpoint Sources.....	86
	Loop 1 Setpoint Sources.....	86
	Loop 1 Profile Setpoint	86
	Loop 2 Setpoint Sources.....	86
	Loop 2 Profile Setpoint	86
16	Profiler	87
	Profile Components.....	87
	Profile Header & Segment Information.....	87
	Profile Starting & Standard Segments.....	88
	Two Loop Profiles	89
	Loop-back Segments.....	90
	Profile Running / Holding vs. Hold Segments	90
	The Auto-Hold Feature.....	91
	Auto Hold Examples	91
	Profile Cycles & Repeat Sequences	92
	Power/Signal Lost Recovery Actions	93
	Profile End Actions	94
	Profile Abort Actions.....	95
17	USB Interface.....	96
	Using the USB Port	96
	USB Memory Stick Folders & Files	96
18	Data Recorder.....	97
	Recordable Values	97
	Recorder Control and Status	97
	Uploading Data	98
	Additional Features & Benefits from the Recorder	98
19	Controller Tuning	99
	PID Sets & Gain Scheduling	99
	Automatic Tuning	100
	Manually Tuning.....	102
	Tuning Control Loops - PID with Primary Output only.....	102
	Tuning Control Loops - PID with Primary & Secondary Outputs.....	103
	Valve, Damper & Speed Controller Tuning	104
	Fine Tuning.....	106
20	Serial Communications	109
	Supported Protocols.....	109
	RS485 Configuration	109

Ethernet Configuration.....	109
Supported Modbus Functions	111
Function Descriptions	111
Exception Responses.....	112
Modbus Parameters.....	113
Data Formats	113
Parameter Register Address Listings	113
Calibration Reminder Parameters	114
Universal Process Input 1 Parameters	114
Universal Process Input 2 Parameters	118
Digital Input Setup Parameters	122
Plug-in Module Slot A Parameters	135
Plug-in Module Slot 1 Parameters.....	137
Plug-in Module Slot 2 Parameters.....	139
Plug-in Module Slot 3 Parameters.....	142
Output 4 Parameters	144
Output 5 Parameters	146
Linear Output 6 Parameters	147
Linear Output 7 Parameters	148
Loop 1 Setpoint Parameters.....	149
Loop 2 Setpoint Parameters.....	150
Aux A Input Parameters	151
Loop 1 Control Parameters	151
Loop 2 Control Parameters	157
Alarm Parameters.....	163
Recorder & Clock Parameters.....	171
Display & Security	176
Instrument Data Parameters	184
Profiler Control & Status Parameters	185
Profile Setup via Modbus.....	187
21 Glossary	204
Active Setpoint	204
Actual Setpoint	204
Alarm Activation Inhibit	204
Alarm Configuration	204
Alarm Duration Inhibit	204
Alarm Operation.....	206
Alarm Types.....	207
Alternate Setpoint	207
Auto Pre-Tune.....	207
Automatic Reset.....	207
Auxiliary Input.....	207

Auxiliary Input Lower Limit	207
Auxiliary Input Offset	208
Auxiliary Input Type.....	208
Auxiliary Input Upper Limit	208
Band Alarm Value	208
Bar Graphs	208
Bias	208
Bumpless Transfer	208
Calibration	209
Cascade Control	209
Clock Configuration.....	209
Communications Write Enable.....	209
Configuration Menu.....	209
Contactor.....	209
Continuous Control	209
Control Configuration	210
Control Deviation.....	210
Control Action.....	210
Control Enable/Disable	210
Control Power Alarm	210
Control Type.....	210
Controller.....	211
Controller Mode.....	211
Correcting Variable	211
CPU.....	211
Custom Display Mode	211
Cycle Time	211
Data Recorder.....	211
Deadband.....	211
Derivative Action	212
Deviation Alarm.....	212
Digital Input	212
Direct Acting Control	212
Display Configuration	213
Display Languages.....	213
Display Resolution	213
Effective Setpoint	213
Engineering Units.....	213
Ethernet.....	213
Gain Scheduling.....	213
Indicator	214

Input Configuration.....	214
Input Filter Time Constant.....	214
Input Range.....	214
Input Span.....	214
Integral Action	214
Invert Digital Input.....	215
Latching Output.....	215
LED	215
Linear Input	215
Linear Output	215
Limit Controller.....	215
Local Setpoints	216
Lock Codes	216
Logical Output Combinations.....	216
Examples of Logical Outputs	216
Loop Alarm.....	217
LSD	217
mADC.....	217
Main Menu	217
Main Setpoint	217
Manual Loop Alarm Time.....	218
Manual Mode	218
Manual Reset.....	218
Master & Slave Controllers	218
Modbus RTU.....	219
Modbus TCP	219
Minimum Motor On Time	219
Modulating Valve	220
Motor Travel Time.....	220
Multi-Point Scaling	220
mVDC.....	220
On-Off Control.....	220
On-Off Differential	221
On-Off Hysteresis	221
Operation Mode	221
Output Configuration.....	221
Overlap/Deadband.....	221
PC Software	222
PD Control.....	223
PI Control	223
PID Control.....	223
PID Gain Sets	223

PLC	223
Pre-Tune	223
Power Output Limits.....	224
Primary Proportional Band	224
Process High Alarm	224
Process Inputs	224
Process Low Alarm <i>n</i> Value	224
Process Variable (PV).....	225
Process Variable Offset	225
Profile Control Menu	225
Profile Events	225
Profile Header	225
Profile Segments.....	225
Profile Setup Menu.....	225
Profiler	226
Profiler Mode.....	226
Proportional Control	226
Rate.....	226
Rate of Change Alarm.....	226
Ratio Control	226
Recorder Configuration	227
Recorder Option.....	227
Recorder Menu	227
Relay	227
Remote Setpoint (RSP).....	227
Retransmit Output	227
Retransmit Output Scale Maximum	227
Retransmit Output Scale Minimum	228
Reset To Defaults	228
Reverse Acting Control	228
RS485	228
RTD	228
Scaled Input Upper Limit.....	229
Scaled Input Lower Limit.....	229
Secondary Proportional Band	229
Self-Tune.....	229
Sensor Break Pre-Set Power.....	230
Serial Communications Configuration.....	230
Serial Communications Option	230
Set Valve Closed Position.....	230
Set Valve Opened Position	230

Setpoint	230
Setpoint Upper Limit	231
Setpoint Lower Limit	231
Setpoint Ramp Rate.....	231
Setpoint Selection	231
Setup Wizard.....	231
Solid State Relay (SSR).....	232
Solenoid Valve	232
Supervisor Mode	232
Thermocouple	232
Three Point Stepping Control.....	232
Time Proportioning Control	233
Trend Displays	233
Tuning	233
Tuning Menu	233
Triac	234
USB Menu.....	234
Valve Motor Drive Control (VMD)	234
Valve Position or Flow Indication.....	234
Valve Open & Closed Limits	234
22 PC Software	235
Using the PC Software.....	235
Instrument Simulation	236
Configuring the Connection	236
Instrument Configuration.....	239
Main Parameter Adjustment.....	239
Extending Functionality via Software	240
Profile Creation and Editing	242
Data Recorder Trend Upload & Analysis.....	243
23 Specifications	245
Universal Process Inputs	245
General Input 1 and 2 Specifications	245
Thermocouple Input.....	245
Resistance Temperature Detector (RTD) Input.....	246
DC Linear Input	246
Input Functions	247
Auxiliary Input.....	247
Digital Inputs	248
Output Specifications	249
Communications	251
Control Loop(s)	252
Alarms	253

	Profiler Option	253
	Data Recorder Option	254
	Display.....	254
	Operating Conditions	254
	Conformance Norms	254
	Dimensions	254
24	Pro-EC44 Product Coding	255
25	Table of Contents	257

**Austria**

PMA Prozeß- und Maschinen-Automation GmbH
Liebermannstraße F01
2345 Brunn am Gebirge
Tel.: +43 (0)2236 691-121
Fax: +43 (0)2236 691-102
Email: info@west-cs.com

**China**

Danaher Setra-ICG
Tianjin Co. Ltd. No. 28 Wei 5 Road
The Micro-Electronic Industry Park TEDA
Xiqing District • Tianjin 300385
Tel.: +86 22 8398 8098 • Sales: +86 400 666 1802
Fax: +86 22 8398 8099
Email: tc.sales@danaher.com

**France**

WEST Control Solutions
France
Tel.: +33 (1) 77 80 90 40
Fax: +33 (1) 77 80 90 50
Email: info@west-cs.com

**Germany**

PMA Prozeß- und Maschinen-Automation GmbH
Miramstraße 87
34123 Kassel
Tel.: +49 (0)561 505-1307
Fax: +49 (0)561 505-1710
Email: info@west-cs.com

**United Kingdom**

WEST Control Solutions
The Hyde Business Park
Brighton • East Sussex • BN2 4JU
Tel.: +44 (0)1273 606271
Fax: +44 (0)1273 609990
Email: info@west-cs.com

**United States**

WEST Control Solutions
1675 Delany Road
Gurnee • IL 60031-1282
Tel.: 800 866 6659
Fax: 847 782 5223
Email: custserv.west@dancon.com